

UNIFIED FACILITIES CRITERIA (UFC)

ARMORIES AND ARMS ROOMS



APPROVED FOR PUBLIC RELEASE; DISTRIBUTION UNLIMITED

UNIFIED FACILITIES CRITERIA (UFC)

ARMORIES AND ARMS ROOMS

Any copyrighted material included in this UFC is identified at its point of use.
Use of the copyrighted material apart from this UFC must have the permission of the
copyright holder.

U.S. ARMY CORPS OF ENGINEERS

NAVAL FACILITIES ENGINEERING COMMAND (Preparing Activity)

AIR FORCE CIVIL ENGINEER CENTER

Record of Changes (changes are indicated by \1\ ... /1/)

Change No.	Date	Location

FOREWORD

The Unified Facilities Criteria (UFC) system is prescribed by MIL-STD 3007 and provides planning, design, construction, sustainment, restoration, and modernization criteria, and applies to the Military Departments, the Defense Agencies, and the DoD Field Activities in accordance with [USD \(AT&L\) Memorandum](#) dated 29 May 2002. UFC will be used for all DoD projects and work for other customers where appropriate. All construction outside of the United States is also governed by Status of Forces Agreements (SOFA), Host Nation Funded Construction Agreements (HNFA), and in some instances, Bilateral Infrastructure Agreements (BIA.) Therefore, the acquisition team must ensure compliance with the most stringent of the UFC, the SOFA, the HNFA, and the BIA, as applicable.

UFC are living documents and will be periodically reviewed, updated, and made available to users as part of the Services' responsibility for providing technical criteria for military construction. Headquarters, U.S. Army Corps of Engineers (HQUSACE), Naval Facilities Engineering Command (NAVFAC), and the Air Force Civil Engineer Center (AFCEC) are responsible for administration of the UFC system. Defense agencies should contact the preparing service for document interpretation and improvements. Technical content of UFC is the responsibility of the cognizant DoD working group. Recommended changes with supporting rationale should be sent to the respective service proponent office by the following electronic form: [Criteria Change Request](#). The form is also accessible from the Internet sites listed below.

UFC are effective upon issuance and are distributed only in electronic media from the following source:

- Whole Building Design Guide web site <http://dod.wbdg.org/>.

Refer to UFC 1-200-01, *General Building Requirements*, for implementation of new issuances on projects.

AUTHORIZED BY:

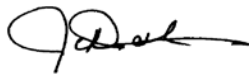

JAMES C. DALTON, P.E.
Chief, Engineering and Construction
U.S. Army Corps of Engineers



JOSEPH E. GOTT, P.E.
Chief Engineer
Naval Facilities Engineering Command



JOE SCIABICA, SES
Director
Air Force Civil Engineer Center

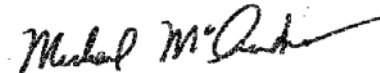

MICHAEL McANDREW
Director, Facilities Investment and Management
Office of the Deputy Under Secretary of Defense
(Installations and Environment)

AUTHORIZED BY:

**UNIFIED FACILITIES CRITERIA (UFC)
NEW DOCUMENT SUMMARY SHEET**

Subject: UFC 4-215-01, *Armories and Arms Rooms*

Cancel: This is a new Tri-Service document. This is to be used in conjunction with other Tri-Service UFC documents in the development of Armories and Arms Rooms. A listing of documents is in Appendix A - References

Description: The UFC 4-215-01, *Armories and Arms Rooms*, represents another step in the effort to bring uniformity to the planning, design and construction of military facilities. The document requires the use of the latest building codes including the International Building Code.

New military requirements were incorporated and improved references to other documents have been identified for energy conservation, sustainable development, and antiterrorism standards.

This is the first Tri-Service criteria document to be published for this building type.

Reason for Creating this Document: The existing guidance was inadequate for the following reasons:

- The Services are currently using their own individual criteria documents, ex. AF Guides, NAVFAC Instructions, Army Technical Instructions, and Marines P-numbered management manuals. This document promotes criteria uniformity, and reduces current reliance upon individual Service specific documents.
- The existing Service-specific guidance did not properly reference and identify recently updated and published Tri- Service documents.

Impact: The following direct benefits will result with the new UFC 4-215-01, *Armories and Arms Rooms*.

- Creation of a single source for common DoD Armory criteria and an accurate reference to individual Service-specific documents.
- Eliminates misinterpretation and ambiguities that could lead to design and construction conflicts.
- Facilitates updates and revisions and promotes agreement and uniformity of design and construction between the Services.

Unification Issues:

Section 2-8.1: Air Force's approval authority for installation of emergency power systems at Armories is the Air Force Civil Engineer Center (AFCEC), as opposed to the other Services which allow the Installation Commander as the approval authority.

Section 3-4.3.2: Army does not require provision for card readers with key pads at equipment cage (platoon, company) doors and office doors.

Section 3-4.6.1: The Army does not require lockers to be provided for showering or changing clothes. This is due to the Army typically constructing only "Arms Rooms" within other facilities; thus, the existence of an "Arms Room" would not require showers and associated lockers for showering and changing.

CONTENTS

CHAPTER 1 INTRODUCTION	1
1-1 PURPOSE AND SCOPE.....	1
1-2 APPLICABILITY.....	1
1-3 GENERAL BUILDING REQUIREMENTS.	1
1-4 REFERENCES.	1
1-5 GLOSSARY.....	1
CHAPTER 2 PLANNING CRITERIA	3
2-1 PHYSICAL SECURITY.....	3
2-1.1 Threat Assessment.	3
2-2 SCOPE OF FACILITY.	3
2-2.1 Armories and Arms Rooms.	4
2-3 ARMORY PLANNING DETERMINATIONS.	5
2-3.1. Inventory and Number of Personnel to be Serviced.....	5
2-3.2. Weapons Distribution Protocols.	5
2-3.3. Weapons Storage.	6
2-3.4. Weapons Cleaning Stations.....	6
2-4 STAFFING AND OFFICE MANAGEMENT.....	7
2-5 OTHER FACILITY FUNCTIONS.	7
2-6 SPACE ASSESSMENT.....	7
2-6.1 Other Functions.	7
2-6.2 Break Area.	7
2-6.3 Loading Considerations.	7
2-6.4 Support Areas.	7
2-7 BUILDING SITE PLANNING.....	8
2-7.1 Location.	8
2-7.2 Parking.....	8
2-7.3 Fencing.	9
2-8 BUILDING SUPPORT SYSTEMS.....	9
2-8.1 Emergency Power.....	9
CHAPTER 3 GENERAL DESIGN CRITERIA.....	11
3-1 GENERAL.....	11
3-2 PHYSICAL SECURITY.....	11

3-3	SITE WORK.	11
3-4	ARCHITECTURE AND INTERIOR DESIGN.	11
3-5	ELECTRICAL DESIGN.	11
3-5.1	Telecommunications Systems.	11
3-5.2	Power.	11
3-5.3	Lighting.	11
3-5.4	Emergency Power.	11
3-5.5	Electronic Security Systems (ESS).	11
3-6	HEATING, VENTILATION, AND AIR CONDITIONING (HVAC) DESIGN.	13
3-6.1	Maximum Ductwork Size.	13
3-6.2	Controls.	13
3-6.3	Ventilation.	13
3-7	PLUMBING DESIGN.	13
3-8	FIRE PROTECTION.	14
3-8.1	Fire Suppression Systems.	14
3-8.2	Fire Alarm Systems.	14
3-8.3	Installations with a Single Armory	14
3-8.4	Mass Notification Systems.	14
CHAPTER 4 SPECIFIC DESIGN CRITERIA.		16
4-1	INTRODUCTION.	16
4-2	ISSUE PORTS.	16
APPENDIX A REFERENCES.		32
APPENDIX B DRAWINGS		36
B-1	A PROTOTYPE ARMORY.	36
B-2	ISSUE PORT.	37
B-3	TYPICAL ARMS ROOM.	41
APPENDIX C GLOSSARY		42

TABLES

TABLE 4-1	ENTRY CANOPY.	17
TABLE 4-2	VESTIBULE	18
TABLE 4-3	CORRIDOR.	19

TABLE 4-4 DUTY OFFICE	20
TABLE 4-5 MECHANICAL ROOM	21
TABLE 4-6 STAFF TOILETS/SHOWERS	22
TABLE 4-6A EXTERIOR TOILETS	23
TABLE 4-7 ELECTRICAL CLOSET	24
TABLE 4-8 COMMUNICATIONS ROOM	25
TABLE 4-9 JANITORS CLOSET.....	26
TABLE 4-10 COVERED WEAPONS CLEANING AREA	27
TABLE 4-10A INTERIOR WEAPONS CLEANING AREA	28
TABLE 4-11 WEAPONS REPAIR AND MAINTENANCE WORKSHOPS	29
TABLE 4-12 WEAPONS STORAGE AREA.....	30

CHAPTER 1 INTRODUCTION

1-1 PURPOSE AND SCOPE.

This UFC provides requirements for a unified approach to the planning, programming, and design of DoD Armories and Arms Rooms. These facilities store only very limited amounts of small arms ammunition; thus, this document does not cover facilities utilized for storing ammunition or explosives. For facilities storing ammunition or explosives that fall under DoD 6055.09-M, *DOD Ammunition and Explosive Safety Standards*, refer to requirements in UFC 4-420-01, *Ammunition and Explosives Storage Magazines*.

1-2 APPLICABILITY.

This UFC applies to all military service elements and contractors involved in the planning, design, and construction of DoD armories and arms rooms worldwide. The information in this UFC applies to the design of all construction projects, to include new construction, additions, alterations, and renovation projects in the continental United States (CONUS) and outside the continental United States (OCONUS).

1-3 GENERAL BUILDING REQUIREMENTS.

Comply with UFC 1-200-01, *General Building Requirements*. UFC 1-200-01 provides applicability of model building codes and government-unique criteria for typical design disciplines and building systems, as well as for accessibility, antiterrorism, security, high performance and sustainability requirements, and safety. Use this UFC in addition to UFC 1-200-01 and the UFCs and government criteria referenced therein.

1-4 REFERENCES.

Appendix A contains a list of references used in this document. The publication date of the code or standard is not included in this document. In general, the latest available issuance of the reference is used.

1-5 GLOSSARY.

Appendix C contains acronyms, abbreviations, and terms.

This Page Intentionally Left Blank

CHAPTER 2 PLANNING CRITERIA

2-1 PHYSICAL SECURITY.

Physical security is that part of security concerned with physical measures designed to safeguard personnel; to prevent unauthorized access to equipment, installations, material, and documents; and to safeguard them against espionage, sabotage, damage, and theft.

The applicable DoD and Service-specific physical security documents for Armories and Arms Rooms are as follows:

- DoD Military Handbook 1013/1A, Section 2
- DoDM 5100.76, *Physical Security of Sensitive Conventional Arms, Ammunition, and Explosives*, for pre-design considerations.
- Navy: OPNAVINST 5530.13C, *Physical Security Instruction for Conventional Arms, Ammunitions, and Explosives*
- Marine Corps: MCO 5530.14A, *Marine Corps Physical Security Program Manual*
- Army: Army Regulation (AR) 190-11, *Physical Security for Arms, Ammunition, and Explosives*
- Air Force: Air Force Instruction (AFI) 31-101, *Integrated Defense (FOUO)*.

Include representatives from the intended facility users, as well as the designated military installation intelligence officers, operational officers, security and law enforcement officials, and engineering and planning personnel in the planning and design process.

2-1.1 Threat Assessment.

Generally, arms storage structures are designed according to the physical security regulations and instructions listed above. Local threat considerations need to be taken into consideration and the "design basis threat" can be established using UFC 4-020-01, *DoD Security Engineering Facilities Planning Manual*.

2-2 SCOPE OF FACILITY.

Comply with DoDM 5100.76. Armory facility functional design is driven by inventory control, storage, equipment repair and maintenance, delivery, management methodologies, and any additional functions accommodated in the specific facility. These functions and how they drive the design of the facility are described in greater detail herein. Arms, ammunition and explosives (AA&E) storage is driven by Security Risk Categories (SRC) per DoDM 5100.76. For Army Arms Rooms representative risk categories are established per AR 190-11.

2-2.1 Armories and Arms Rooms.

“Armory” is a facility, usually free-standing, containing one or more separate weapon storage and distribution spaces. See Appendix B, Drawing B-1, for the layout of a typical Armory. An “Arms room” is a single room built inside, or adjacent to, another building for the purpose of storing and distributing weapons. See Appendix B, Drawing B-3, for the layout of a typical Arms Room.

2-2.1.1 Armory.

Navy and Marine Corps armories are categorized in UFC 2-000-05N, *Facility Planning Criteria for Navy/Marine Corps Shore Installations*, Category Code 143 45. An armory for Fleet Marine Force air and ground units provides temperature and humidity controlled, and secure space for storing and maintaining weapons assigned to personnel. In planning for a Marine Corps armory, the method is to build the space requirements by weapon and ammunition count. To calculate space requirements, the space allocation for a Navy and Marine Corps armory can be determined by using the UFC 2-000-05N, *Facility Planning Criteria for Navy/Marine Corps Shore Installations* space planning tool on the NAVFAC portal. Adjustments can be made for units that do not conform to infantry battalion model, such as squadron or logistics battalion. Navy and Marine Corps Armories store limited amounts of safety and security ammunition and may also be authorized for storing ammunition with those personal weapons that have been authorized for storage by the Commanding Officer in a container in the facility.

The Army also has large free-standing weapons storage facilities in specialized circumstances (identification of which is FOUO); however, the Army more typically stores weapons in an Arms Room within another facility.

The weapons/equipment within the armory is typically stored within cabinets, wall lockers, gun racks, shelving, boxes/crates, or wall boards. In most cases, this method of storage allows some stacking of the weapons/equipment which can reduce floor space requirements. See Appendix B, Drawing B-1, for the typical layout of an Armory.

2-2.1.1.2 Portable Armory.

An armory constructed and designed to be relocatable. They are a custom fabrication built in accordance with Naval Surface Warfare Specification 3046-93.2. Relocatable Armories are not permanent Armory solutions. Portable armories must also comply with DoDM 5100.76 and the Service-specific requirements within AR 190-11 and OPNAVINST 5530.13C.

2-2.1.2 Arms Rooms.

Army arms rooms are constructed according to the requirements of Army Regulation (AR) 190-11; these are facilities, similar in function to the weapons storage spaces of armories, with very limited maintenance and repair facilities. Standard Army practice is to have an arms room built inside or adjacent to each line company headquarters building. Arms rooms are also located inside military police buildings, special operations centers, reserve training facilities, and other installations. If required, add space for a small amount of ammunition storage. See Appendix B, Drawing B-3, for the layout of a typical Arms Room.

Air Force arms rooms are governed by Air Force Instruction (AFI) 31-101, ETL 11-18, *Small Arms Range Design and Construction*, and AFMAN 32-1084, *Facility Requirements*. Air Force weapons repair and maintenance facilities are normally located in a Combat Arms Facility.

Navy and Marine Corps arms rooms must comply with OPNAVINST 5530.13C.

2-2.1.3 Modular Arms Room.

Governed by Federal Specification (Fed. Spec.) AA-V-2737, *Modular Vault Systems*. Modular arms rooms' construction is placed inside a building during new construction, is inserted inside an existing building, or is an addition to an existing structure. It may be a free-standing arms room, constructed of precast concrete or steel plate. The physical security requirements for a modular arms room are the same as for a standard arms room or armory building. These are not to be confused with portable armories.

2-3 ARMORY PLANNING DETERMINATIONS.

Planning the size and layout of armory facilities depends upon the following determinations.

2-3.1. Inventory and Number of Personnel to be Serviced.

The facility inventory, number of workers, and number of personnel to be serviced drives the overall area of the facility. Use individual service space planning criteria and user input to determine specific needs. This area will be provided by the DoD Form 1391 for the project.

2-3.2. Weapons Distribution Protocols.

The weapons distribution protocol affects the layout of the facility. In most armories the weapons are distributed through Issue Ports. The design of the Issue Ports is a determinant of the types of weapons that can be issued. Issue Port size is regulated by Physical Security requirements. See Issue Port details in Appendix B.

Larger weapons and accessories may require special distribution procedures that mandate that weapons and accessories be distributed through the facility doorways. The protocol for these issues will be established by the facility user.

For Arms Rooms, weapons issue is through the Class 5 Armory Door or day gate. The day gate can be configured with an issue window or as a Dutch door to facilitate issuance and return of weapons and equipment.

2-3.3. Weapons Storage.

Determine weapons storage requirements during initial project planning. High-density storage systems may be necessary to accommodate the quantity and variation of the weapons and supporting equipment requiring storage. The configuration and mobility of selected storage systems may impact the funding source required to obtain the system, either as facility construction costs or installed equipment costs (FF&E), and must be programmed accordingly in the project funding documentation (DD 1391, etc.) by the facility planner. Configuration of storage systems will also impact decisions regarding structural systems, fire protection requirements, security systems and lighting.

2-3.4. Weapons Cleaning Stations.

The type, number, and arrangement of weapons cleaning station worktables and accessories are an integral part of the building functional planning. The cleaning process will take place in a covered area, typically located outside but adjoining the facility in temperate climates and incorporated into the facility in harsh climates. Outside covered areas will be scheduled at one-half square footage. Supplemental heating may be necessary for outside cleaning areas.

Interior weapons cleaning rooms are located outside the secure perimeter of the armory.

The size of the weapons cleaning area is based on the number of personnel using the space, and the amount of time allowed for cleaning. For Air Force facilities, AFMAN 32-1084 requires 15 SF per each person cleaning weapons concurrently.

2-3.4.1 Location.

The location of the weapons cleaning areas will be reflected in the space planning allowances shown in the project funding documentation (DD 1391, etc.), either as an exterior covered space square footage requirement or as additional interior square footage in the facility.

2-3.4.2 Interior Location.

For interior locations, the type, number, and arrangement of weapons cleaning and repair worktables and accessories will be designed as an integral part of the building interior.

2-4 STAFFING AND OFFICE MANAGEMENT.

Determine staffing requirements for armories to size the administrative areas, staff lockers, and toilets, in accordance with the individual service's space criteria. Staffing for arms rooms would be located in an adjacent office with visual control of the room entrance.

2-5 OTHER FACILITY FUNCTIONS.

For the armory to accommodate one or more of the following additional functions, specialized areas will be required. These spaces should be outside of the secure perimeter of the armory.

- Personnel training functions - classrooms.
- Non-Standard weapons inventory, servicing, and/or fabrication functions – machine shops, wood shop, indoor firing range.
- Small arms shop (Category Code 215 10) contained in a Navy or Marine Corps Armory or for a small arms shop in support of multiple facilities.

2-6 SPACE ASSESSMENT.

See the Functional Data Sheets in Chapter 4 for additional information on the space types and their relationships to each other.

2-6.1 Other Functions.

If the program calls for it, add a gunsmith shop for weapon construction and maintenance. Air Force weapons repair and maintenance are normally provided in a Combat Arms Facility. Add other functions defined by the program.

2-6.2 Break Area.

Armory areas as required for, recycling bins space, and coffee machine, microwave oven and refrigerator.

2-6.3 Loading Considerations.

If a loading dock is necessary to accommodate material transfer in and out of the facility, coordinate it with storage requirements.

2-6.4 Support Areas.

Accommodate staff needs such as offices and administrative tasks, toilets, lockers, showers, and janitor closets. The areas are determined by the staffing requirements. These spaces can be located outside of the secure perimeter of the armory.

2-6.4.1 Building Services Areas.

These spaces accommodate building services such as mechanical, electrical, and communications. Provide separate Mechanical and Electrical Equipment rooms, sized according to the size of the facility, with direct access to the exterior only. The Mechanical and Electrical rooms are not required to be within the secure perimeter. Provide lockable doors for the Mechanical and Electrical rooms. Interior access is prohibited.

- Where requested by user, provide toilet facilities accessed from the exterior of the building as part of the building program, in addition to interior toilets.
- Trash & Garbage Removal and Recycling. Garbage storage, removal and recycling systems will be determined prior to design, based on installation requirements.
- Segregated areas for special wastes.
- Other Facility Functions. These spaces will be determined by the specific facility requirements and the individual service's space planning criteria.

2-7 BUILDING SITE PLANNING.

The armory functions are important to the mission for any installation. Consider the following factors in the site selection and planning.

2-7.1 Location.

The following must be addressed when locating a facility:

- In locating the facility, the first consideration is physical security. Provide a clear, unobstructed view of the fence openings and entry path from the facility entrance.
- Site selection must take into account the requirement that an armed response force must be able to respond on-site to the armory location within 15 minutes of an alarm or report of intrusion, in accordance with DoDM 5100.76.
- For Armories, another important siting consideration is locating it in close proximity to the operational hub of the regiment, battalion, or company, when possible.

2-7.2 Parking.

Provide adequate parking as close to the facility as possible within antiterrorism (AT) requirements. Parking must be located outside of clear zone.

2-7.3 Fencing.

DoDM 5100.76 does not require fencing for armories. Provide security fencing around the perimeter of the entire building site when dictated by the installation/base commander. When fencing is required, per DoDM 5100.76, establish clear zones that extend a minimum of 12 feet (3.66 m) on the outside and 30 feet (9.14 m) on the inside of fence (or to the maximum extent within available land space if minimum requirements cannot be met). For more stringent clear zone requirements for Marine Corps facilities, refer to MCO 5530.14A.

2-8 BUILDING SUPPORT SYSTEMS.

2-8.1 Emergency Power.

Coordinate with Installation Commanding Officer to determine if emergency power is required to support the critical mission and identify the requirements, including load to be served and time duration, in the project funding documents. Emergency power may be required to provide air-conditioning/humidity control in weapons storage areas, and other systems to support the mission. **Service Exception:** For **Air Force**, the Air Force Civil Engineering Center (AFCEC) is the approval authority for installation of emergency power systems.

This Page Intentionally Left Blank

CHAPTER 3 GENERAL DESIGN CRITERIA

3-1 GENERAL.

3-2 PHYSICAL SECURITY.

See Chapter 2 paragraph “Physical Security” and “Armories and Arms Rooms” for additional design requirements.

3-3 SITE WORK.

3-4 ARCHITECTURE AND INTERIOR DESIGN.

3-5 ELECTRICAL DESIGN.

In addition to the criteria established in UFC 1-200-01 and the references therein, comply with the following armory-specific requirements:

3-5.1 Telecommunications Systems.

Refer to specific requirements for spaces in Chapter 4, Room Data Sheets. In arms rooms, consider providing phone to allow communication with security forces.

3-5.2 Power.

Provide ceiling-mounted power cord reels at each worktable in weapons maintenance areas. Floor mounted flush receptacles and conduit stub-ups are not permitted.

3-5.3 Lighting.

Provide lamp breakage protection (wire guards) for lighting fixtures in rooms as required in spaces in Chapter 4, Room Data Sheets. Provide site security lighting in accordance with the requirements of UFC 3-530-01. Provide security lighting for all arms storage areas and facilities. The lighting must be sufficient to allow guards or individuals responsible for maintaining surveillance to see illegal acts such as forced entry or the unauthorized removal of arms. Provide a minimum of 0.2 foot-candles (2 lux) illumination measured on the horizontal plane at ground level, sufficient to allow detection of unauthorized activity. Locate exterior light switches so they are only accessible to authorized personnel.

3-5.4 Emergency Power.

When identified in the project funding documents, provide emergency power generator to support mission requirements. Army Regulation AR190-11 requires a minimum 4 hour power source (battery) to operate security features.

3-5.5 Electronic Security Systems (ESS).

Coordinate ESS requirements for the facility with the Service-specific documents identified in Chapter 2 paragraph titled "Physical Security". Design the ESS in accordance with UFC 4-021-02, *Electronic Security Systems*.

3-5.5.1 Intrusion Detection System (IDS)

Provide an IDS including the following, unless there is a documented exception.

- Point sensors on doors and other "accessible openings" exceeding 96 square inches (619 square centimeters)
- Interior volumetric sensors, including coverage of all shelving and gun racks. When required by user, provide individual IDS sensing for each weapons storage area. Ensure IDS components are not rendered useless by blocked line of sight.
- A duress alarm (panic button) at each issue port (for Navy and Marine facilities)
- Line supervision on transmission lines. If line supervision is unavailable, two independent means of alarm signal transmission is required.
- Reporting to a central monitoring station where alarms will sound and from which a response force can be dispatched. An alarm bell located only at the protected location is not acceptable.

3-5.5.2 Access Control Systems

Provide card reader with keypads at entry to building. Provide key pad, with card reader when required, at the entrance of each interior weapons storage area. Card readers must be approved for use by service's security authorities.

3-5.5.3 Closed Circuit Television (CCTV)

Provide CCTV system when required.

3-6 HEATING, VENTILATION, AND AIR CONDITIONING (HVAC) DESIGN.

In addition to UFC 1-200-01, *General Building Requirements*, and the stated and cross referenced requirements for HVAC Systems, comply with the following:

3-6.1 Maximum Ductwork Size.

Where possible, limit maximum ductwork size penetrating the perimeter of the secure area (roof or walls) to less than the dimensions for a "man-passable opening" as defined in MIL HDBK 1013/1A. Where the "man-passable opening" dimensions must be exceeded, provide hardening at the opening in accordance with MIL HDBK 1013/1A.

3-6.2 Controls.

Specify direct digital control (DDC) system per UFGS 23 09 23.13 20, *BACnet Direct Digital Control Systems for HVAC*, or UFGS 23 09 23, *Lonworks Direct Digital Control for HVAC and Other Building Control Systems*. Coordinate DDC specification to ensure proper interface to existing or planned base-wide DDC/EMCS system.

Refer to Room Data Sheets in Chapter 4 for spaces which require humidity control.

3-6.3 Ventilation.

Ventilation systems for the Weapons Repair and Maintenance Workshops and any interior weapons cleaning areas must comply with UFC 3-410-04, *Industrial Ventilation*.

3-7 PLUMBING DESIGN.

In addition to UFC 1-200-01, *General Building Requirements*, and cross referenced requirements therein, comply with the following in the design of the plumbing system for this facility type:

- Provide hose bibbs at exterior weapons cleaning areas. In lieu of hose bibbs, provide freeze proof hydrants where the climate demands.
- Locate air compressor(s) and air dryer(s) in the Mechanical Room when feasible. If outdoors, provide outdoor rated compressed air system, mounted on a slab, for the covered weapons cleaning area and the indoor weapons repair and

maintenance workshops. Provide compressed air outlets at the worktables. Equip interior compressed air outlets with ceiling hung hose reels.

3-8 FIRE PROTECTION.

Refer to UFC 1-200-01, *General Building Requirements*, and comply with stated and cross referenced requirements for Fire Protection Systems, with the following additions or exceptions for this facility type:

3-8.1 Fire Suppression Systems.

For armories 5,000 square feet (464.5 sq. m.) or greater, provide automatic sprinkler protection throughout the facility and for the outdoor weapons cleaning areas when attached to the building.

3-8.2 Fire Alarm Systems.

Provide a Fire Alarm System for armories of 5,000 square feet (464.5 sq. m.) or greater. Fire alarm systems are not required for portable armories.

3-8.3 Installations with a Single Armory

For Installations that have only one armory, and that armory houses the Installation's Security Forces weapons and ammunition, mitigation of risks associated with loss of security forces weapons and ammunition due to fire shall be provided by one of the methods below.

- Provide automatic sprinkler protection throughout the building, regardless of size.
- The installation Security Officer must maintain a written contingency plan in the event the armory and contents are destroyed due to fire. This written plan must be approved by the installation Commanding Officer.

3-8.4 Mass Notification Systems.

When required for an inhabited building, provide mass notification system in accordance with UFC 4-021-01, *Design and O&M: Mass Notification Systems*.

This Page Intentionally Left Blank

CHAPTER 4 SPECIFIC DESIGN CRITERIA

4-1 INTRODUCTION.

This chapter identifies the specific design requirements for each functional area as outlined in the space program. Tables 4-1 through 4-12 provide this data in a standard Functional Data Sheet format.

Armory planning determinations, along with other basic building design and operation determinations, establish the size, layout, and design of the facility functional spaces. The various components below may apply to an armory or an arms room project.

The interior construction specialties, equipment and furnishings criteria provided in these tables are broken down as follows:

- **Casework/Built-in Equipment.** This includes anything physically attached or plumbed to the building such as counters, cabinets, casework, toilet accessories, and window treatments.
- **Furnishings, Fixtures, and Equipment (FF&E).** This includes contractor-furnished, contractor-installed loose items such as desks, tables, chairs, bookshelves, and televisions (if mounted, TV mount would be built-in).
- **User-provided FF&E.** This includes all government-furnished, government-installed items, which are typically limited to office equipment such as computers, printers, copiers, and projectors (if mounted, projector mount would be built-in).

4-2 ISSUE PORTS.

Provide issue ports for Navy and Marine Corps armories. The issue port accommodates distribution of weapons to authorized personnel. For the Navy and Marines, OPNAVINST 5530.13C and MCO 5530.14A require openings “not to exceed 190 in-sq when open; and when not in use will be secured with material comparable to that forming the adjacent walls.” (NOTE: DoDM 5100.76 requires IDS point sensors on any “accessible openings,” which is defined as 96 sq in (0.06 square meters)). Provide at least one issue port at each caged or separate unit arms room.

See Appendix B – Drawings for Issue Port drawings.

TABLE 4-1 ENTRY CANOPY

Description/Usage	Provide a canopy or enclosure at the main entrance to the facility for personnel who must wait at the facility entrance. It may be a column supported canopy. Determine the size by the number of personnel to be served, arrival and departure considerations, and the procedure followed.
Ceiling Ht.	11' – 4" (3.45 m) min (new construction)
Finishes	Floor: Sealed Concrete Base: N/A Walls: N/A Ceiling: Painted or prefinished
Plumbing	None
HVAC	None
Fire Protection	None
Power	None
Lighting	Provide per Chapter 3
Communication	None
Acoustics	None
Casework/Built-in Equipment	None
Furnishings Fixtures & Equip. (FF&E)	None
User-Provided Equip. (GF&GI)	None
For use during project execution by the appropriate Service agency	
Occupancy	
Min. net ft²(m²)	

TABLE 4-2 VESTIBULE

Description/Usage	A vestibule is appropriate to prevent major heat loss and gain, and to screen and protect visitors prior to entry into the facility proper.
Ceiling Ht.	11' – 4" (3.45 m) min (new construction)
Doors	Use hollow metal doors with half glass for the outside door(s). If the inside of the vestibule is on the secure perimeter, the inside door must be GSA-approved Class 5 Armory Door. At the inside of the armory door, provide a day gate for added security.
Finishes	Floor: Sealed Concrete; consider recessed entry mat. Base: Resilient Walls: Epoxy on CMU or concrete. Provide wall guard protection at locations subject to cart traffic. Ceiling: Painted exposed structure
Plumbing	None
HVAC	Provide per Chapter 3
Fire Protection	Provide per Chapter 3
Power	Provide per Chapter 3
Lighting	Provide per Chapter 3. Provide lamp protection.
Communication	Provide per Chapter 3
Acoustics	None
Casework/Built-in Equipment	None
Furnishings Fixtures & Equip. (FF&E)	None
User-Provided Equip. (GF&GI)	None
For use during project execution by the appropriate Service agency	
Occupancy	
Min. net ft²(m²)	

TABLE 4-3 CORRIDOR

Description/Usage	Circulation. The semi-public areas of the facility allow for circulation to other functions.
Ceiling Ht.	11' – 4" (3.45 m) min (new construction)
Finishes	Floor: Sealed Concrete Base: Resilient Walls: Epoxy on CMU or concrete/expanded metal. Provide wall guard protection at locations subject to cart traffic. Ceiling: Painted exposed structure
Plumbing	None
HVAC	Provide per Chapter 3
Fire Protection	Provide per Chapter 3
Power	Provide per Chapter 3
Lighting	Provide per Chapter 3. Provide lamp protection.
Communication	Provide per Chapter 3
Acoustics	None
Casework/Built-in Equipment	Tackboards
Furnishings Fixtures & Equip. (FF&E)	None
User-Provided Equip. (GF&GI)	None
For use during project execution by the appropriate Service agency	
Occupancy	
Min. net ft²(m²)	

TABLE 4-4 DUTY OFFICE

Description/Usage	Administrative office
Ceiling Ht.	8' – 0" (2.44 m) min
Finishes	Floor: Resilient tile Base: Resilient Walls: Painted walls. Ceiling: Acoustical panel
Plumbing	None
HVAC	Provide per Chapter 3
Fire Protection	Provide per Chapter 3
Power	Provide per Chapter 3
Lighting	Provide per Chapter 3
Communication	Provide per Chapter 3
Acoustics	Provide per Chapter 3
Casework/Built-in Equipment	None
Furnishings Fixtures & Equip. (FF&E)	Office furniture
User-Provided Equip. (GF&GI)	None
For use during project execution by the appropriate Service agency	
Occupancy	
Min. net ft²(m²)	

TABLE 4-5 MECHANICAL ROOM

Description/Usage	Mechanical equipment housed here. Access only from the exterior of the building.
Ceiling Ht.	11' – 4" (3.45 m) min. (new construction)
Finishes	Floor: Sealed Concrete Base: Resilient Walls: Painted CMU or concrete Ceiling: Painted exposed structure
Plumbing	Provide per Chapter 3
HVAC	Provide per Chapter 3
Fire Protection	Provide per Chapter 3
Power	Provide per Chapter 3
Lighting	Provide per Chapter 3
Communication	Provide per Chapter 3
Acoustics	None
Casework/Built-in Equipment	None
Furnishings Fixtures & Equip. (FF&E)	None
User-Provided Equip. (GF&GI)	None
For use during project execution by the appropriate Service agency	
Occupancy	
Min. net ft²(m²)	

TABLE 4-6 STAFF TOILETS/SHOWERS

Description/Usage	Male and female toilets and shower facilities.
Ceiling Ht.	8' – 0" (2.44 m) min
Finishes	Floor: Porcelain tile Base: Porcelain or Ceramic tile Walls: Ceramic tile wainscot 48" high except, full height ceramic tile or solid surface material in showers. Painted walls. Ceiling: Moisture resistant acoustical panel ceiling or mold-resistant gypsum board.
Plumbing	Lavatories, urinals, water closets, showers
HVAC	Provide per Chapter 3
Fire Protection	Provide per Chapter 3
Power	Provide per Chapter 3
Lighting	Provide per Chapter 3
Communication	Provide per Chapter 3
Acoustics	No special requirements
Casework/Built-in Equipment	Vanity cabinets for lavatories. Toilet partitions and accessories. Provide solid surfacing material at countertops. Lockers and benches if required
Furnishings Fixtures & Equip. (FF&E)	
User-Provided Equip. (GF&GI)	None
For use during project execution by the appropriate Service agency	
Occupancy	
Min. net ft²(m²)	

TABLE 4-6A EXTERIOR TOILETS

Description/Usage	Optional male and female toilet facilities, accessed from the exterior of the building. Primarily required for Armories in remote locations.
Ceiling Ht.	8' – 0" (2.44 m) min
Finishes	Floor: Sealed Concrete Base: None Walls: Painted walls. Ceiling: Moisture resistant acoustical panel ceiling or mold-resistant gypsum board.
Plumbing	Lavatories, urinals, water closets
HVAC	Provide per Chapter 3
Fire Protection	Provide per Chapter 3
Power	Provide per Chapter 3
Lighting	Provide per Chapter 3
Communication	Provide per Chapter 3
Acoustics	No special requirements
Casework/Built-in Equipment	Toilet accessories.
Furnishings Fixtures & Equip. (FF&E)	None
User-Provided Equip. (GF&GI)	None
For use during project execution by the appropriate Service agency	
Occupancy	
Min. net ft²(m²)	

TABLE 4-7 ELECTRICAL CLOSET

Description/Usage	Electrical panels and other equipment. Access only from the exterior of the building.
Ceiling Ht.	11' – 4" (3.45 m) min (new construction)
Finishes	Floor: Sealed Concrete Base: Resilient Walls: Painted CMU or concrete Ceiling: Painted exposed structure
Plumbing	None
HVAC	Provide per Chapter 3
Fire Protection	Provide per Chapter 3
Power	Provide per Chapter 3
Lighting	Provide per Chapter 3
Communication	Provide per Chapter 3
Acoustics	None
Casework/Built-in Equipment	None
Furnishings Fixtures & Equip. (FF&E)	None
User-Provided Equip. (GF&GI)	None
For use during project execution by the appropriate Service agency	
Occupancy	
Min. net ft²(m²)	

TABLE 4-8 COMMUNICATIONS ROOM

Description/Usage	Communications equipment housed here.
Ceiling Ht.	11' – 4" (3.45 m) min. (new construction)
Finishes	Floor: Sealed Concrete Base: Resilient Walls: Painted. Provide ¾-inch (19 mm) plywood attached to wall for attachment of IT and telephone equipment. Ceiling: Painted exposed structure
Plumbing	None
HVAC	Provide per Chapter 3
Fire Protection	Provide per Chapter 3
Power	Provide per Chapter 3
Lighting	Provide per Chapter 3
Communication	Provide per Chapter 3
Acoustics	None
Casework/Built-in Equipment	Communications racks
Furnishings Fixtures & Equip. (FF&E)	None
User-Provided Equip. (GF&GI)	None
For use during project execution by the appropriate Service agency	
Occupancy	
Min. net ft²(m²)	

TABLE 4-9 JANITORS CLOSET

Description/Usage	Cleaning supplies and equipment storage.
Ceiling Ht.	8' – 0" (2.44 m) min
Finishes	Floor: Sealed Concrete Base: Resilient Walls: Painted Ceiling: Painted GWB ceiling.
Plumbing	Floor mop sink
HVAC	Provide per Chapter 3
Fire Protection	Provide per Chapter 3
Power	Provide per Chapter 3
Lighting	Provide per Chapter 3
Communication	None
Acoustics	None
Casework/Built-in Equipment	Storage shelving for cleaning supplies and equipment; mop rack.
Furnishings Fixtures & Equip. (FF&E)	None
User-Provided Equip. (GF&GI)	None
For use during project execution by the appropriate Service agency	
Occupancy	
Min. net ft²(m²)	

TABLE 4-10 COVERED WEAPONS CLEANING AREA

Description/Usage	Exterior column supported canopy with concrete slab. Determine the size by the number of personnel to be served, arrival and departure considerations, and the procedure followed. Provide space for weapons cleaning tables, cleaning equipment, and clearing of weapons.
Ceiling Ht.	11' – 4" (3.45 m) min (new construction)
Finishes	Floor: Concrete Base: N/A Walls: N/A Ceiling: Painted ceiling.
Plumbing	Hose bibbs. Use freeze proof hydrants in lieu of hose bibbs where climate demands. Provide compressed air system with compressed air outlets at worktables (50 psi and 15 scfm, verify these requirements during design). Provide emergency eyewash station.
HVAC	Provide radiant heating. Coordinate the type of heating allowed with fire protection requirements where solvent vats are provided.
Fire Protection	Provide per Chapter 3
Power	Provide per Chapter 3
Lighting	Provide per Chapter 3. Provide lighting at 30 footcandles (300 lux) ambient and 50 footcandles (500 lux) at task with vacancy sensor (manual on, vacancy off). Provide lamp protection (wire guards).
Communication	None
Acoustics	None
Casework/Built-in Equipment	Weapons cleaning tables
Furnishings Fixtures & Equip. (FF&E)	Weapons cleaning equipment, weapons clearing barrels, hazardous material storage for oily rags. Trash containers.
User-Provided Equip. (GF&GI)	None
For use during project execution by the appropriate Service agency	
Occupancy	
Min. net ft²(m²)	

TABLE 4-10A INTERIOR WEAPONS CLEANING AREA

Description/Usage	Interior building space for weapons cleaning. Required for areas with harsh climates. Determine the size by the number of personnel to be served, arrival and departure considerations, and the procedure followed. Provide space for weapons cleaning tables, cleaning equipment, and clearing of weapons.
Ceiling Ht.	11' – 4" (3.45 m) min (new construction)
Finishes	Floor: Sealed Concrete Base: N/A Walls: Epoxy Paint Ceiling: Painted exposed structure.
Plumbing	Compressed air system with ceiling hung hose reels at worktables (50 psi and 15 scfm, however, verify requirements during design). Deep sinks. Emergency eyewash station.
HVAC	Provide per Chapter 3. Coordinate the type of heating allowed with fire protection requirements where solvent vats are provided. Provide special ventilation in accordance with Chapter 3, HVAC Design, to control solvent vapors.
Fire Protection	Provide per Chapter 3
Power	Provide per Chapter 3
Lighting	Provide per Chapter 3. Provide lighting at 30 footcandles (300 lux) ambient and 50 footcandles (500 lux) at task with vacancy sensor (manual on, vacancy off). Provide lamp protection (wire guards).
Communication	None
Acoustics	None
Casework/Built-in Equipment	Weapons cleaning tables
Furnishings Fixtures & Equip. (FF&E)	Weapons cleaning equipment, weapons clearing barrels, hazardous material storage for oily rags.
User-Provided Equip. (GF&GI)	None
For use during project execution by the appropriate Service agency	
Occupancy	
Min. net ft²(m²)	

TABLE 4-11 WEAPONS REPAIR AND MAINTENANCE WORKSHOPS

Description/Usage	Weapons repair and regular maintenance. The square footage of repair and maintenance workspace areas will be determined by the program. In some armories this space may have secondary functions as a training space.
Ceiling Ht.	11' – 4" (3.45 m) min (new construction)
Finishes	Floor: Sealed Concrete Base: Resilient Walls: Epoxy on CMU or concrete. Ceiling: Painted exposed structure
Plumbing	Compressed air system with ceiling hung hose reels (50 psi and 15 scfm, however, verify requirements during design). Hand sink and emergency eyewash.
HVAC	Provide humidity control to limit the relative humidity to no greater than 40% at 80 degrees Fahrenheit (26.7 degrees Celsius). Design to 68 deg F (20.0 deg C) dry bulb and 40% RH for indoor design heating conditions, and 75 deg F (23.9 deg C) dry bulb and 40% RH for indoor design cooling conditions. Provide special ventilation in accordance with Chapter 3, HVAC Design, to control solvent vapors.
Fire Protection	Provide per Chapter 3
Power	Provide per Chapter 3. Provide power reels.
Lighting	Provide per Chapter 3. Provide lamp protection. Provide lighting at 30 footcandles (300 lux) ambient and 50 footcandles (500 lux) at task
Communication	Provide per Chapter 3. Provide duress alarm at each issue port.
Acoustics	None
Casework/Built-in Equipment	None
Furnishings Fixtures & Equip. (FF&E)	Weapons maintenance workbenches, tables, stools, hand tools, power tools and parts cabinets
User-Provided Equip. (GF&GI)	Tools and Parts
For use during project execution by the appropriate Service agency	
Occupancy	
Min. net ft²(m²)	

TABLE 4-12 WEAPONS STORAGE AREA

Description/Usage	The weapons and equipment within the armory are typically stored within cabinets, gun racks, shelving, boxes/crates, or wall boards. In most cases, this method of storage allows some stacking of the weapons/equipment which can reduce floor space requirements. Provide storage space for gun cases, ammunition cases, etc. The areas are determined by analysis of the need, the number of personnel to be served, and the defined delivery cycles. An armory will have multiple cages, each for a company-sized unit (approximately 105 personnel), with weapons racks, locking cage door with a key / pushbutton lock. Provide a minimum of one issue port for each caged area or separate arms room. Provide space for weapon cleaning. Allow space for a small workbench with power if required by User. Provide workbench if requested.
Ceiling Ht.	11' – 4" (3.45 m) clear to underside of concrete (new construction)
Finishes	Floor: Sealed Concrete Base: Resilient Walls: Epoxy on CMU or concrete. Ceiling: Painted exposed structure.
Plumbing	None
HVAC	Provide humidity control to limit the relative humidity to no greater than 40% at 80 degrees Fahrenheit (26.7 degrees Celsius). If personnel will be working in these areas, design to 68 deg F (20.0 deg Celsius) dry bulb and 40% RH for indoor design heating conditions, and 75 deg F (23.9 deg Celsius) dry bulb and 40% RH for indoor design cooling conditions.
Fire Protection	Provide per Chapter 3
Power	Provide per Chapter 3. Provide power for workbench(es) if required by User.
Lighting	Provide per Chapter 3. Provide lamp protection (wire guards).
Communication	Provide per Chapter 3. Provide duress alarm at each issue port for Navy and Marine facilities. Locate motion detector on corridor cage wall.
Acoustics	No special requirements
Casework/Built-in Equipment	Equipment cages of woven wire mesh partitions, shelving, and wallboards. If storage requirements warrant high-density or wall-mounted storage shelving/racks/boards, these items must be coordinated and included in construction. Consider structural loads, IDS sensors and fire protection systems during design of high-density storage. Storage shelving/racks may require attachment to floor or structure.

TABLE 4-12 WEAPONS STORAGE AREA

Furnishings Fixtures & Equip. (FF&E)	Free-standing weapons racks and cabinets. Workbenches, if requested.
User-Provided Equip. (GF&GI)	None
For use during project execution by the appropriate Service agency	
Occupancy	
Min. net ft²(m²)	

APPENDIX A REFERENCES

DEPARTMENT OF DEFENSE

<http://www.dtic.mil/whs/directives/corres/pub1.html>

DoD 6055.09-M, *DOD Ammunition and Explosive Safety Standards*

DoDM 5100.76, *Physical Security of Sensitive Conventional Arms, Ammunition, and Explosives*

MIL-HDBK-1013/1A, *Military Handbook Design Guidelines For Physical Security of Facilities*, http://www.wbdg.org/ccb/NAVFAC/DMMHNAV/1013_1a.pdf

U.S. Government Specification (Naval Surface Warfare Center) 3046-93.2, *Purchase Spec Portable Vault*

DEPARTMENT OF THE AIR FORCE

http://www.wbdg.org/ccb/browse_org.php?o=33

AFI 31-101, *Integrated Defense (FOUO)*

AFI 32-1024, *Standard Facility Requirements*

AFMAN 32-1084, *Facility Requirements*

ETL 11-18, *Small Arms Range Design and Construction*

DEPARTMENT OF THE ARMY

<http://armypubs.army.mil/>

AR 190-11, *Physical Security of Arms, Ammunition, and Explosives*

DEPARTMENT OF THE NAVY

<http://doni.daps.dla.mil/allinstructions.aspx>

OPNAVINST 5530.13C, *Physical Security Instruction for Conventional Arms, Ammunition, and Explosives*

HEADQUARTERS, MARINE CORPS

MCO 5530.14A, *Marine Corps Physical Security Program Manual*
http://www.marines.mil/Portals/59/Publications/MCO%205530_14A.pdf

FEDERAL SPECIFICATIONS

http://www.navfac.navy.mil/navfac_worldwide/specialty_centers/exwc/products_and_services/capital_improvements/dod_lock/Documents/FedSpecs.html

Federal Specification (Fed Spec.) AA-D-600D, *Door, Vault, Security*

Fed Spec. AA-V-2737, *Modular Vault Systems*

Fed Spec FF-L-2937, *Combination Lock, Mechanical*

MILITARY SPECIFICATIONS

http://www.navfac.navy.mil/navfac_worldwide/specialty_centers/exwc/products_and_services/capital_improvements/dod_lock/Documents/MilitarySpecifications.html

Military Specification MIL-P-43607J, *Padlock, Key Operated, High Security, Shrouded Shackle*

Military Specification MIL-H-29181C, *Hasp, High Security, Shrouded, for High and Medium Security Padlock*

UNIFIED FACILITIES CRITERIA

http://www.wbdg.org/ccb/browse_cat.php?o=29&c=4

UFC 1-200-01, *General Building Requirements*

UFC 2-000-05N (P-80), *Facility Planning Criteria for Navy/Marine Corps Shore Installations*

UFC 1-202-01, *Host Nation Facilities in Support of Military Operations.*

UFC 3-120-01, *Design: Sign Standards*

UFC 3-201-02, *Landscape Architecture*

UFC 3-410-04, *Industrial Ventilation*

UFC 3-530-01, *Design: Interior and Exterior Lighting and Controls*

UFC 4-020-01, *DoD Security Engineering Facilities Planning Manual*

UFC 4-021-01, *Design and O&M: Mass Notification Systems*

UFC 4-021-02, *Electronic Security Systems*

UFC 4-022-03, *Security Fences and Gates*

UFC 4-420-01, *Ammunition and Explosive Storage Magazines*

UNIFIED FACILITIES GUIDE SPECIFICATIONS

http://www.wbdg.org/ccb/browse_cat.php?c=3

UFGS 23 09 23.13 20, *BACnet Direct Digital Control Systems for HVAC*

UFGS 23 09 23, *Lonworks Direct Digital Control for HVAC and Other Building Control Systems*

This Page Intentionally Left Blank

APPENDIX B DRAWINGS

B-1 A PROTOTYPE ARMORY.

The plan below is a prototype armory plan.

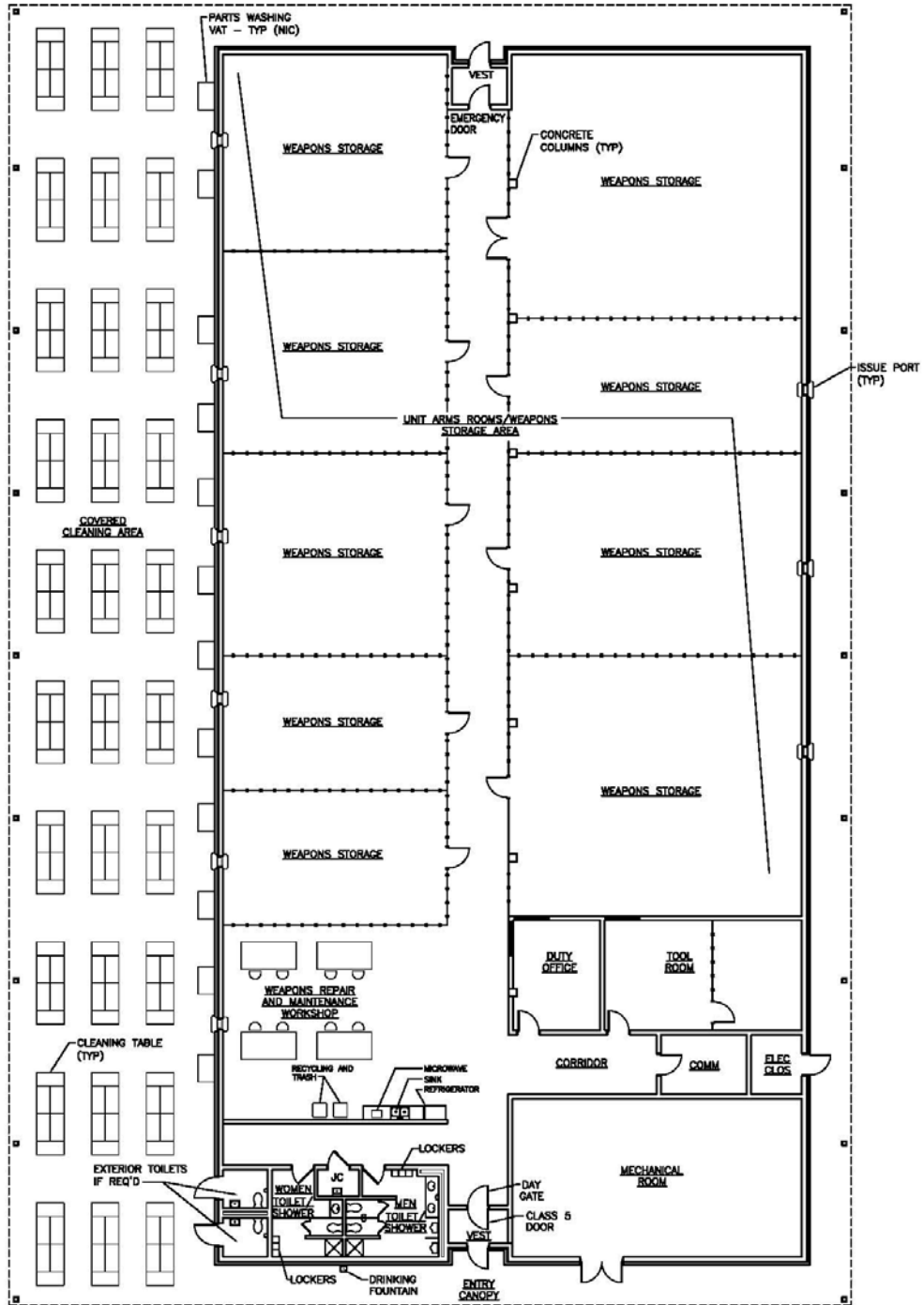

B-2 ISSUE PORT.

The drawings below are a preferred design for an issue port. All steel materials for the issue port must be hot-dip galvanized.

Wall Section at Issue Port

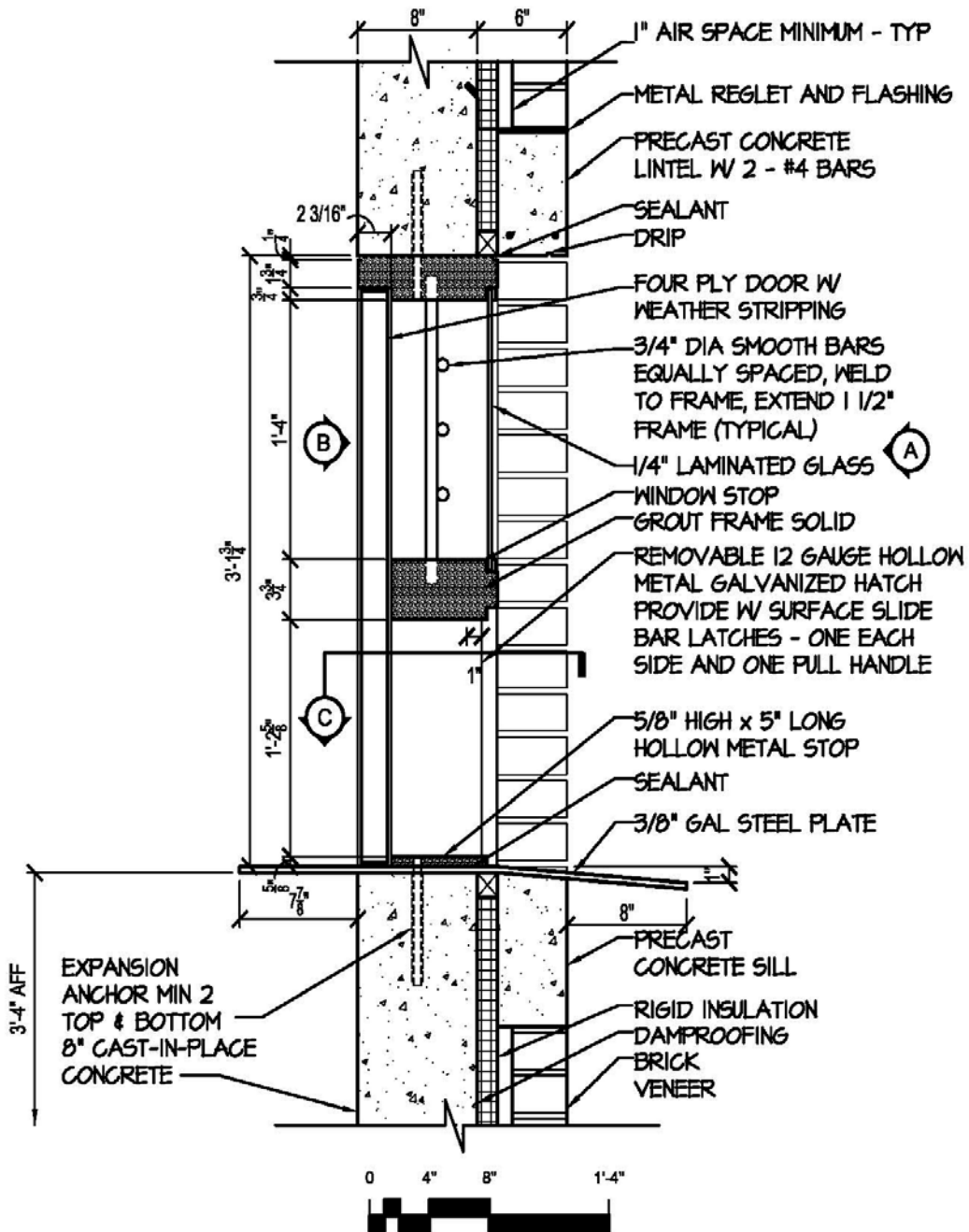

A. Exterior Wall Elevation of Issue Port

The issue port maximum opening is 190 square inches (15" x 12.5" = 187.5 sq in).

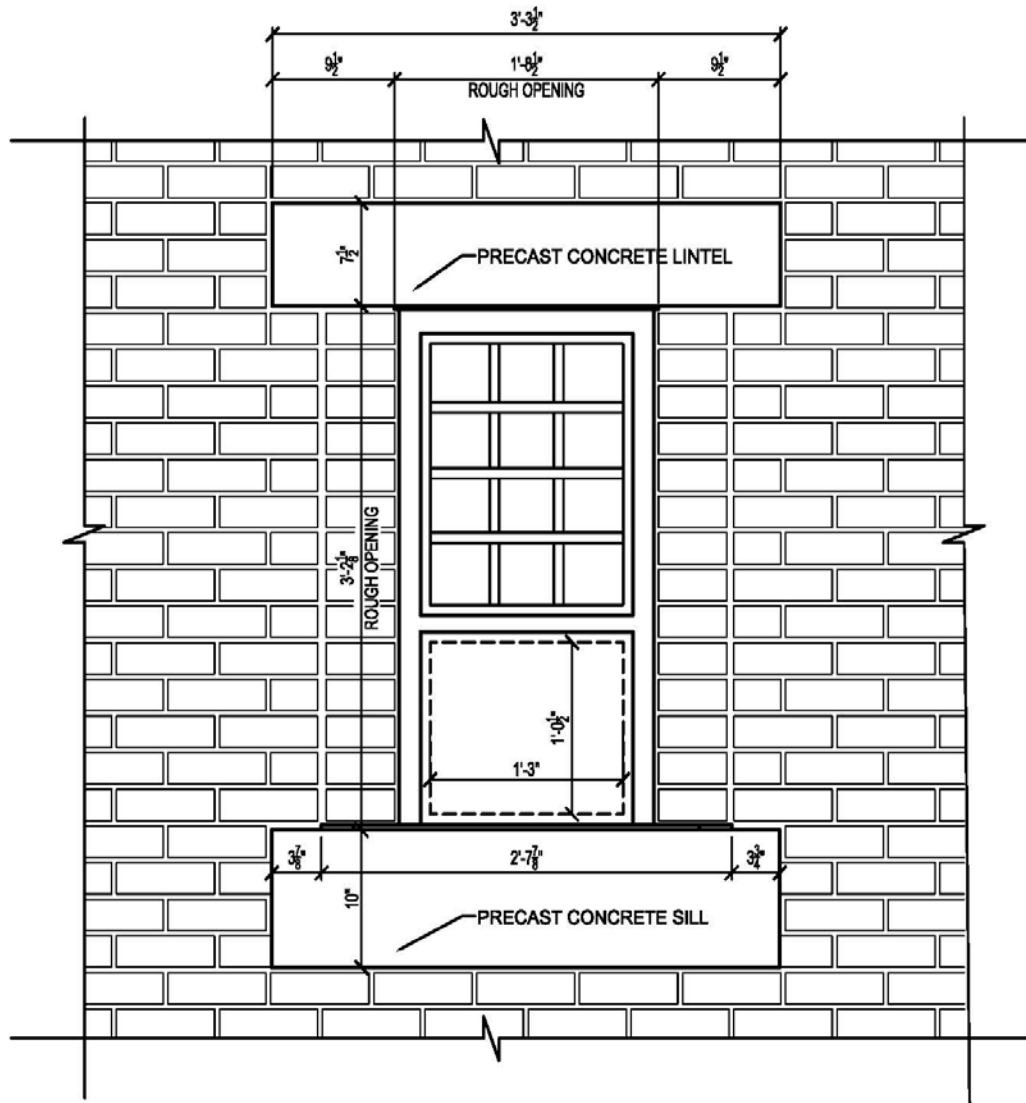

B. Inside Issue Port Door Elevation

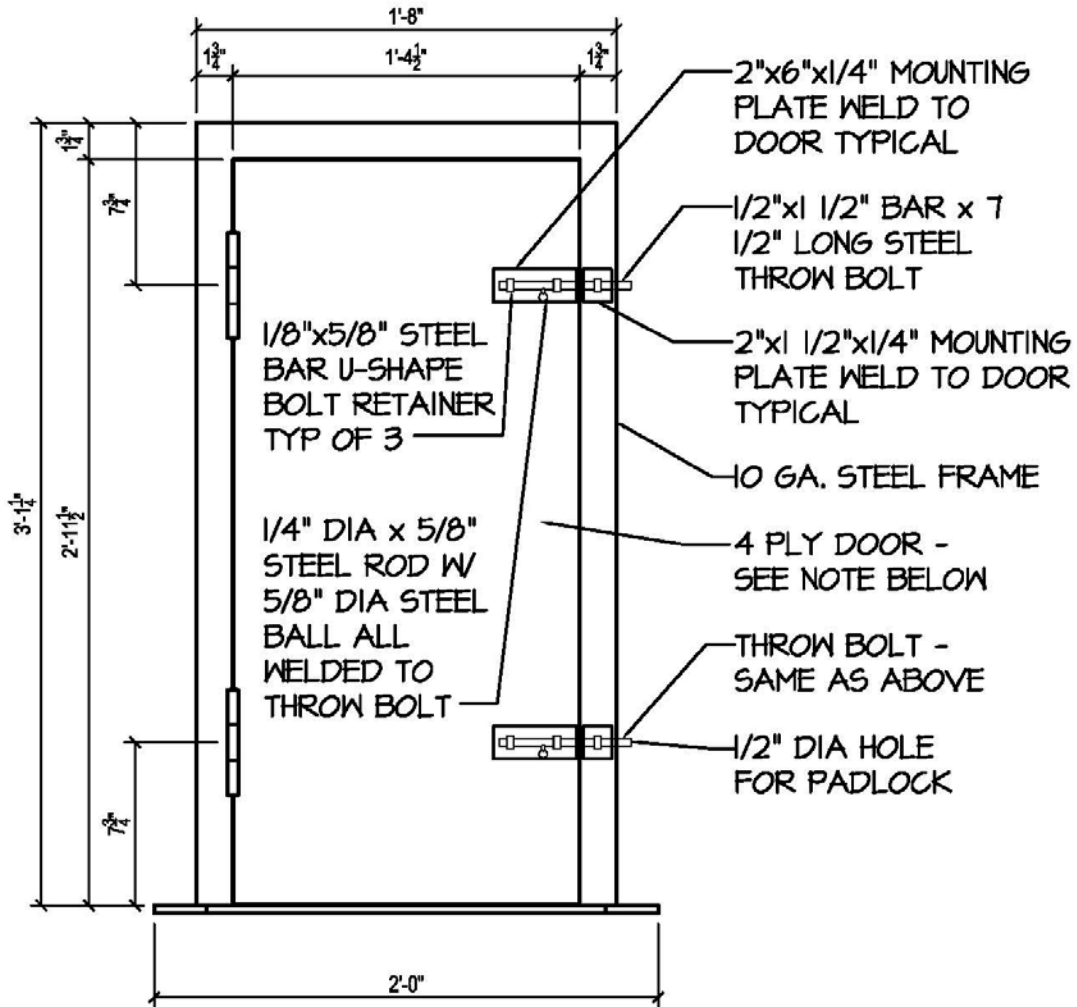

NOTE: 4-PLY DOOR CONSISTS OF 3/16" STEEL PLATE ON THE INSIDE OVER 1/4" POLYCARBONATE SHEET OVER 1 3/4" SOLID CORE WOOD WITH 10 GA. STEEL SHEET FACE PLATE AND EDGES



C. Issue port Half Plate Plan

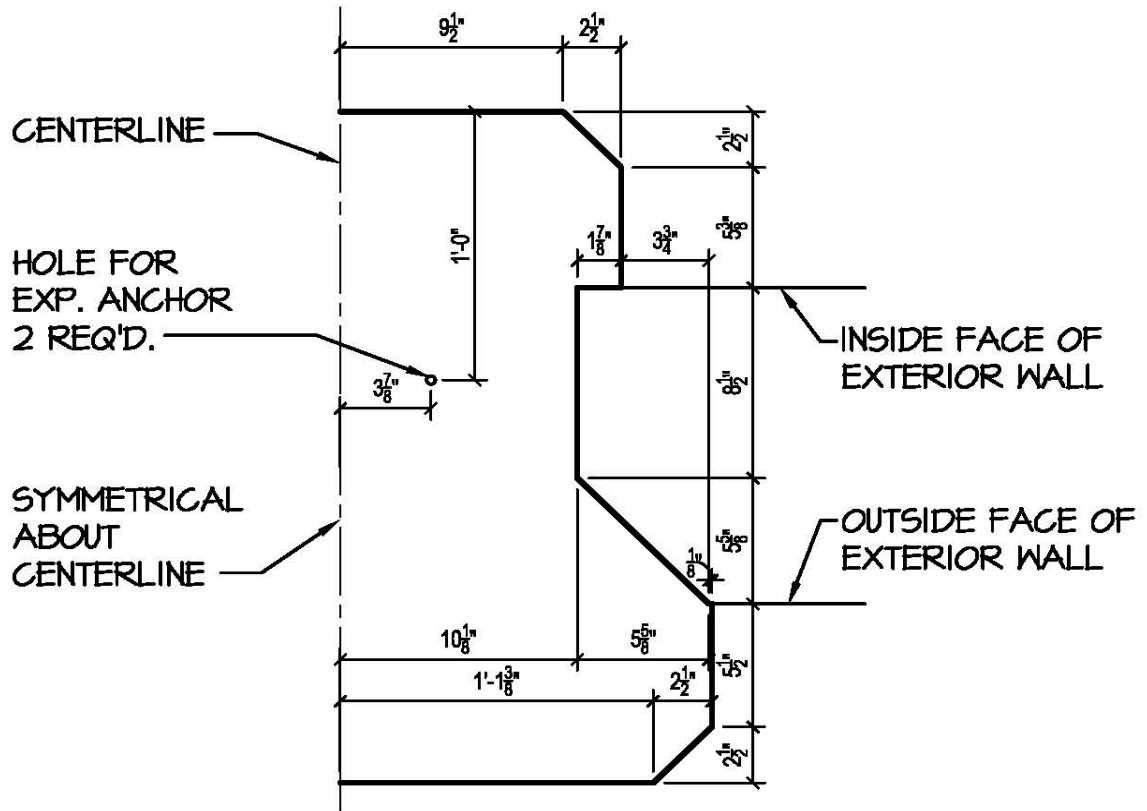

B-3

TYPICAL ARMS ROOM.

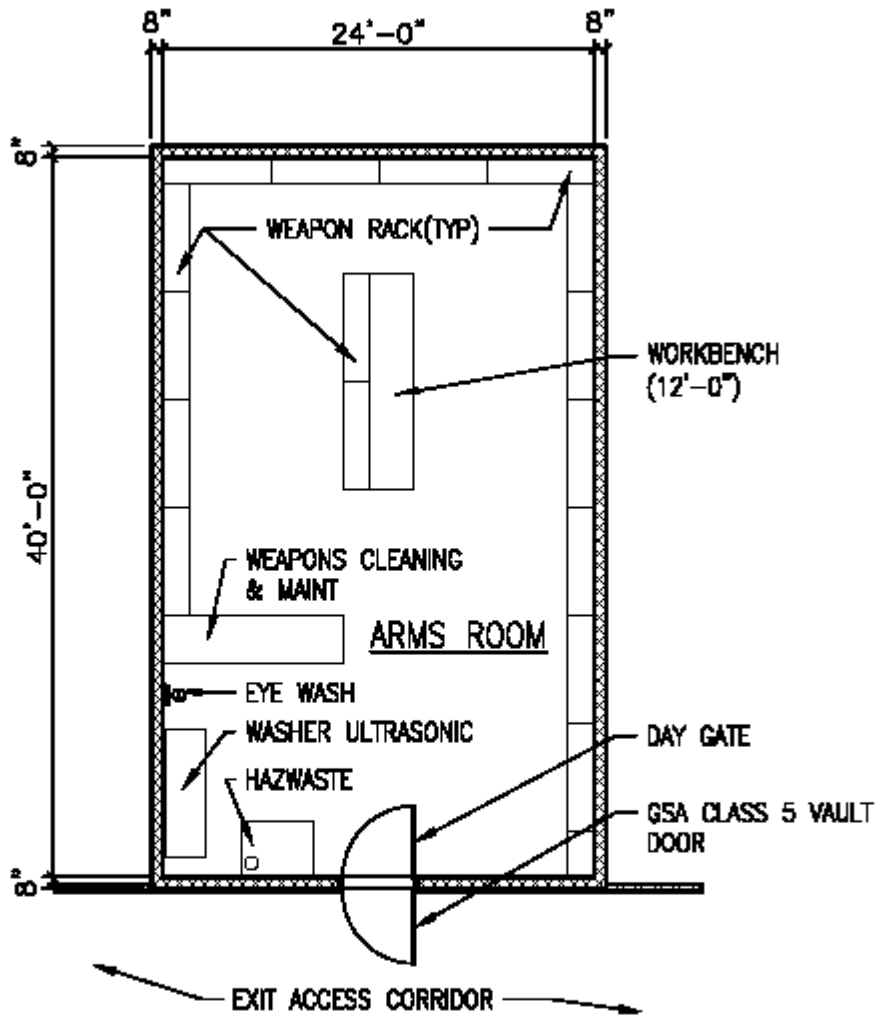

TYP. ARMS ROOM LAYOUT

SCALE: 1/8" = 1'-0"

APPENDIX C GLOSSARY

ACRONYMS

AA&E	Arms, Ammunition and Explosives
AFCEC	Air Force Civil Engineer Center
AFI	Air Force Instruction
AFMAN	Air Force Manual
AR	Army Regulation
AT	Antiterrorism
BIA	Bilateral Infrastructure Agreement
C	Celsius
CCTV	Closed Circuit Television
cm	Centimeter
CMU	Concrete Masonry Unit
CONUS	Continental United States
DDC	Direct Digital Controls
deg	Degrees
DoD	Department of Defense
EMCS	Energy Management Control System
ESS	Electronic Security Systems
ETL	Engineering Technical Letter

F	Fahrenheit
Fed Spec	Federal Specification
FF&E	Furniture, Fixtures and Equipment
FOUO	For Official Use Only
GF	Government Furnished
GI	Government Installed
GSA	General Services Administration
GSF	Gross Square Feet
GWB	Gypsum Wallboard
H&S	Headquarters & Support
HQUSACE	Headquarters, U.S. Army Corps of Engineers
HNFA	Host Nation Funded Construction Agreements
Ht	Height
HVAC	Heating, Ventilation and Air Conditioning
IAP	Installation Appearance Plan
IDG	Installation Design Guide
IDS	Intrusion Detection System
in	inch(es)
IT	Information Technology
LEED	Leadership in Energy and Environmental Design

m	Meter
MCO	Marine Corps Order
min	Minimum
mm	Millimeter(s)
NAVFAC	Naval Facilities Engineering Command
O&M	Operation and Maintenance
OCONUS	Outside Continental United States
psi	Pounds per square inch
RH	Relative Humidity
SF	Square Feet
SOFA	Status of Forces Agreements
sm	Square Meter
sq m	Square Meter
Sq ft	Square Foot (Feet)
sq	Square
SRC	Security Risk Categories
STC	Sound Transmission Coefficient
TV	Television

UFC	Unified Facilities Criteria
UFGS	Unified Facility Guide Specification
U.S.	United States