

UNIFIED FACILITIES CRITERIA (UFC)

INTERIOR AND EXTERIOR LIGHTING SYSTEMS AND CONTROLS



APPROVED FOR PUBLIC RELEASE; DISTRIBUTION UNLIMITED

UNIFIED FACILITIES CRITERIA (UFC)
Interior and Exterior Lighting Systems and Controls

Any copyrighted material included in this UFC is identified at its point of use.
Use of the copyrighted material apart from this UFC must have the permission of the
copyright holder.

U.S. ARMY CORPS OF ENGINEERS

NAVAL FACILITIES ENGINEERING COMMAND (Preparing Activity)

AIR FORCE CIVIL ENGINEER SUPPORT AGENCY

Record of Changes (changes are indicated by \1\ ... /1/)

Change No.	Date	Location
<u>1</u>	<u>2/1/2016</u>	<u>Included Luminaire Conversion Kits 2-8.3.1, Included a Navy ONLY Exemption for Linear Light Emitting Diode (LED) lamps 2-8.4. Modified paragraphs 2-1.5, 2.2.3, 2-2.4, 2-4.1.1, 2-4.2.1, 2-8, 2-8.2, 2-8.3, 3-2, 3-9.1, 5-2, 7-2, 7-3.5.1, 6-2, 7-3.5, 7-5.5. Moved Section 7-3 to Chapter 6. Added reference in Appendix A</u>
<u>2</u>	<u>3/3/2016</u>	<u>Updated equipment section to include linear LED lamps in for Navy only projects 2-4.1.1.2. Updated References</u>
<u>3</u>	<u>6/1/2016</u>	<u>Update to allow Linear LED lamps for Air Force and Army projects. Update UL Standard. Update References</u>

This UFC supersedes UFC 3-530-01, Change 2 dated 03 March 2016.

FOREWORD

The Unified Facilities Criteria (UFC) system is prescribed by MIL-STD 3007 and provides planning, design, construction, sustainment, restoration, and modernization criteria, and applies to the Military Departments, the Defense Agencies, and the DoD Field Activities in accordance with [USD \(AT&L\) Memorandum](#) dated 29 May 2002. UFC will be used for all DoD projects and work for other customers where appropriate. All construction outside of the United States is also governed by Status of Forces Agreements (SOFA), Host Nation Funded Construction Agreements (HNFA), and in some instances, Bilateral Infrastructure Agreements (BIA.) Therefore, the acquisition team must ensure compliance with the more stringent of the UFC, the SOFA, the HNFA, and the BIA, as applicable.

UFC are living documents and will be periodically reviewed, updated, and made available to users as part of the Services' responsibility for providing technical criteria for military construction. Headquarters, U.S. Army Corps of Engineers (HQUSACE), Naval Facilities Engineering Command (NAVFAC), and Air Force Civil Engineer Center (AFCEC) are responsible for administration of the UFC system. Defense agencies should contact the preparing service for document interpretation and improvements. Technical content of UFC is the responsibility of the cognizant DoD working group. Recommended changes with supporting rationale should be sent to the respective service proponent office by the following electronic form: [Criteria Change Request](#). The form is also accessible from the Internet sites listed below.

UFC are effective upon issuance and are distributed only in electronic media from the following source:

- Whole Building Design Guide web site <http://dod.wbdg.org/>.

Refer to UFC 1-200-01, *General Building Requirements*, for implementation of new issuances on projects.

AUTHORIZED BY:

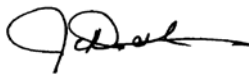

JAMES C. DALTON, P.E.
Chief, Engineering and Construction
U.S. Army Corps of Engineers



JOSEPH E. GOTT, P.E.
Chief Engineer
Naval Facilities Engineering Command



JOE SCIABICA, SES
Director
Air Force Civil Engineer Center



MICHAEL McANDREW
Director, Facilities Investment and Management
Office of the Assistant Secretary of Defense
(Energy, Installations, and Environment)

**UNIFIED FACILITIES CRITERIA (UFC)
SUMMARY SHEET**

Document: UFC 3-530-01, *Interior and Exterior Lighting Systems and Controls, Change 3*

Superseding: UFC 3-530-01, *Design: Interior, Exterior Lighting and Controls, Change 2, 03 March 2016*

Description: This UFC was developed to bring uniformity across the Department of Defense (DoD) Components and:

- Provide requirements for interior and exterior lighting equipment.
- Provide design requirements for many typical applications.

Reasons for Document: This document provides minimum unified requirements and coordinating guidance for planning, designing, constructing, renovating, and maintaining, high performance and sustainable lighting that will enhance DoD facilities by:

- Unified approach to lighting design.
- This UFC captured many of the technology advancements for interior and exterior lighting.
- This document incorporates lessons learned and is reformatted to conform to UFC 1-300-01.

Impact: Improved mission capability through:

- Evaluation of solid state lighting (SSL) as recommended source. SSL may increase first cost, though implementation of controls will reduce overall life cycle cost because of reduced maintenance cycles and longer rated life times.
- Reduced maintenance through longer rated life sources, such as SSL.
- Improved energy efficiency.
- Enhanced facility and installation performance.

Unification Issues:

The Air Force has the following noted exceptions:

- Equipment and Life Cycle Cost Analysis. For LED applications, provide built in failure detection in the luminaire or include labor costs to measure light levels (baseline and 70% output - before the end of the warranty) in the LCCA.
- Airfields. Refer to ETL 11-29 for additional requirements. Use of LED luminaires for airfield ramp, apron, alert, airfield security lighting requires appropriate base level organization coordination

TABLE OF CONTENTS

CHAPTER 1 INTRODUCTION	1
1-1 BACKGROUND.....	1
1-2 PURPOSE AND SCOPE.....	1
1-3 APPLICABILITY.....	1
1-4 GENERAL BUILDING REQUIREMENTS.....	1
1-5 REFERENCES.....	2
1-6 GLOSSARY.....	2
CHAPTER 2 INTERIOR LIGHTING AND CONTROLS.....	3
2-1 PRIORITIES FOR LIGHTING SYSTEMS.....	3
2-1.1 Energy Reduction.....	3
2-1.2 Maintenance Reduction.....	3
2-1.3 Lighting Quality.....	3
2-1.4 Life Cycle Cost.....	4
2-1.5 Lighting System Efficiencies.....	5
2-2 LIGHTING CONTROLS.....	5
2-2.1 Daylighting Control Requirements.....	5
2-2.2 Means of Egress.....	6
2-2.3 Control Strategies.....	6
2-2.4 Network Certification.....	8
2-3 DAYLIGHTING.....	8
2-4 EQUIPMENT.....	8
2-4.1 Light Source Technology.....	8
2-4.2 Ballasts, Drivers, Generators, and Power Supplies.....	10
2-4.3 Surge Protection Device (SPD).....	10
2-5 ELECTRICAL ENERGY MONITORING.....	11
2-6 ELEVATORS.....	11
2-7 ILLUMINATION FOR MEANS OF EGRESS.....	11
2-7.1 Emergency Lighting.....	11
2-7.2 Exit Signs.....	11
2-8 LIGHTING SYSTEM ALTERATIONS.....	11
2-8.1 LIGHTING SYSTEM ALTERATION PRIORITIES.....	12
2-8.2 REDESIGN.....	12

2-8.3	LUMINAIRE REPLACEMENT AND CONVERSION.....	12
2-8.4	LIGHT SOURCE RETROFIT.....	14
CHAPTER 3	INTERIOR APPLICATIONS	17
3-1	INTRODUCTION.....	17
3-2	LIGHTING CALCULATIONS.....	17
3-3	GENERAL BUILDING SPACES.....	18
3-3.1	Corridors.....	18
3-3.2	Stairways.....	20
3-3.3	Lounge Areas.....	21
3-3.4	Storage Rooms.....	23
3-3.5	Mechanical Rooms.....	24
3-3.6	Restrooms.....	25
3-3.7	Telecommunication Room.....	26
3-4	ADMINISTRATIVE SPACES.....	27
3-4.1	Large Lobbies.....	27
3-4.2	Individual Offices.....	29
3-4.3	Individual Offices (Alternate Scheme).....	31
3-4.4	Open Offices.....	34
3-4.5	Open Offices (Alternate Scheme).....	36
3-4.6	Waiting Areas.....	38
3-4.7	Conference Rooms.....	40
3-4.8	Boardrooms / Large Conference Rooms.....	42
3-4.9	Ceremonial Areas.....	44
3-4.10	Office Support Areas.....	46
3-5	EDUCATIONAL SPACES.....	48
3-5.1	Classroom/Training Room.....	48
3-5.2	Auditoriums.....	50
3-6	HEALTHCARE SPACES.....	52
3-6.1	Waiting Rooms.....	52
3-6.2	Pharmacy.....	54
3-7	FOOD SERVICE SPACES.....	56
3-7.1	Kitchens.....	56
3-7.2	Cafeterias.....	58

3-7.3	Enlisted Dining Rooms.	60
3-7.4	Officer Dining Rooms.....	62
3-8	RECREATIONAL SPACES.....	64
3-8.1	Indoor Swimming Pools.....	64
3-8.2	Indoor Tennis Courts.	66
3-8.3	Indoor Basketball Courts.....	68
3-8.4	Locker Rooms.....	70
3-9	MAINTENANCE SPACES.....	71
3-9.1	Vehicle Maintenance Areas.	71
3-9.2	Aircraft Hangers and Shelters.....	73
3-9.3	Motorpools.	75
3-9.4	Warehouses.....	77
3-10	RESIDENTIAL HOUSING.	79
3-10.1	Bedrooms.	79
3-10.2	Hallways.	80
3-10.3	Laundry Rooms.	81
3-10.4	Kitchens.....	82
3-10.5	Dining Room.....	84
3-10.6	Living Rooms.....	85
3-10.7	Rec Rooms.....	87
3-10.8	Bathrooms.	88
3-10.9	Garages.....	89
3-11	HOUSING.....	90
3-11.1	Bachelors Quarters (Barracks).	90
3-12	CHILDCARE SPACES.....	91
3-12.1	Daycare Indoor Play Areas.....	91
3-12.2	Daycare Indoor Rest Areas.....	92
3-13	PARKING.....	93
3-13.1	Parking Structures.	93
CHAPTER 4	EXTERIOR LIGHTING AND CONTROLS.....	95
4-1	PRIORITIES FOR LIGHTING SYSTEMS.....	95
4-1.1	Energy Reduction.	95
4-1.2	Maintenance Reduction.	95

4-1.3	Lighting Quality.....	95
4-1.4	Life Cycle Cost.....	96
4-2	LIGHTING ZONES.....	97
4-3	LIGHTING CONTROLS.....	99
4-3.1	Control Strategies.....	99
4-3.2	Network Certification.....	100
4-4	EQUIPMENT.....	100
4-4.1	Multi-Pin Receptacle.....	100
4-4.2	Light Source Technology.....	101
4-4.3	Ballasts, Drivers, Generators, and Power Supplies.....	102
4-4.4	Surge Protection Device (SPD).....	103
4-4.5	Over Current Protection Device.....	103
4-5	ELECTRICAL ENERGY MONITORING.....	103
4-6	SOLAR LIGHTS.....	103
4-7	REPLACING EXISTING SYSTEMS.....	104
4-7.1	Redesign.....	104
4-7.2	One for One Luminaire Replacement.....	104
4-7.3	Light Source Retrofit.....	105
4-8	SITE DESIGN COORDINATION.....	105
4-9	AIRFIELDS.....	105
CHAPTER 5	EXTERIOR APPLICATIONS.....	107
5-1	INTRODUCTION.....	107
5-2	CALCULATIONS OF LIGHTING FOR EXTERIOR AREAS.....	107
5-3	PARKING FACILITIES.....	108
5-3.1	Parking Lots.....	108
5-4	BUILDING LIGHTING.....	110
5-4.1	Entrances.....	110
5-4.2	Exits.....	111
5-4.3	Housing Areas.....	114
5-5	PEDESTRIAN AREAS.....	116
5-5.1	Walkways.....	116
5-5.2	Plazas.....	118
5-6	VEHICLE TRAFFIC AREAS.....	120

5-6.1	Roadways and Streets.....	120
5-6.2	Driveways.	121
5-7	MARINAS.....	122
5-8	EXTERIOR RECREATIONAL AREAS.	124
5-8.1	Baseball and Softball Fields.....	124
5-8.2	Tennis Courts.	126
5-8.3	Basketball Courts.....	127
5-8.4	Football Fields.	128
5-8.5	Playgrounds.....	130
5-9	OTHER AREAS.....	131
5-9.1	Airfields (Hangar).....	131
5-9.2	Airfields (Apron).	132
CHAPTER 6	SECURITY LIGHTING.....	133
6-1	INTRODUCTION	133
6-2	PHYSICAL SECURITY.....	133
6-2.1	Physical Security System.....	133
6-2.2	Security Lighting Overview.	133
6-2.3	Deterrent Value.....	133
6-2.4	Defining Requirements.	134
6-2.5	Security Lighting Design.	134
6-2.6	Controlled Lighting.....	135
6-2.7	Security Lighting Criteria.....	137
6-3	SECURITY LIGHTING APPLICATIONS.....	138
6-3.1	Building Entrances and Exits.	138
6-3.2	Building Exterior.....	138
6-3.3	Perimeter Lighting.....	139
6-3.4	Entry Control Facilities.....	139
6-3.5	Waterfront.	140
6-3.6	CCTV camera.	142
6-4	ELECTRICAL REQUIREMENTS.....	143
6-4.1	Generators.....	144
6-4.2	Uninterrupted Power Supply.....	144
6-4.3	Flywheels.....	144

6-4.4	Battery Backup	144
6-4.5	Partial Back-up Systems.....	144
6-4.6	Circuiting Techniques.	145
6-4.7	Controls.	145
CHAPTER 7 SECURITY LIGHTING APPLICATIONS		147
7-1	INTRODUCTION.	147
7-2	CALCULATIONS FOR SECURITY LIGHTING.....	147
7-3	ENTRY CONTROL FACILITY.....	148
7-3.1	Access Control Points – Approach Zone.	148
7-3.2	Access Control Points – Access Zone.	149
7-3.3	Access Control Points – Access Zone.	150
7-3.4	Access Control Points – Pedestrian Entry.	151
7-3.5	Access Control Points – Response Zone.....	152
7-4	OTHER AREAS.....	153
7-4.1	Under Vehicle Inspection.....	153
7-4.2	Controlled Perimeters - Single Fence Line.	154
7-4.3	Restricted Area.....	156
7-4.4	Magazines.	157
7-4.5	Piers.	158
APPENDIX A REFERENCES.....		159
APPENDIX B BEST PRACTICES: INTERIOR.....		166
B-1	MAINTENANCE.	166
B-1.1	Visibility.....	166
B-1.2	Glare.....	166
B-1.3	Uniformity.....	167
B-1.4	Illuminance.....	169
B-1.5	Surface Brightness.	169
B-2	LIGHT SOURCES.	171
B-2.1	Technical Characteristics.....	171
B-2.2	Light Source Efficacy.	171
B-2.3	Material Issues.....	171
B-2.4	Recycling.	172
B-3	EQUIPMENT PERFORMANCE.	172

B-3.1	Flicker.....	172
B-3.2	Noise.....	172
B-3.3	Interference.....	172
B-3.4	Effects of Temperature.....	172
B-3.5	Life.....	173
B-4	CONTROL APPROACHES.....	173
B-4.1	Occupancy Based Controls.....	173
B-4.2	Bi-Level and Multi-Level Switching.....	174
B-4.3	Light Level Tuning.....	174
B-4.4	Scene Based Dimming.....	174
B-4.5	Manual Switching.....	175
B-4.6	Time Clocks.....	175
B-4.7	Personal Control.....	175
B-4.8	Network Control Systems.....	175
B-4.9	Interior Controls Summary.....	175
B-5	CONTROL EQUIPMENT.....	179
B-5.1	Sensors.....	179
B-5.2	Manual.....	182
B-5.3	Time Controls.....	183
B-6	NETWORK CONTROL SYSTEM.....	183
B-7	EMERGENCY AND EXIT LIGHTING.....	184
B-7.1	Testing of Emergency Lighting Equipment.....	185
B-8	REPLACEMENT OF LUMINAIRES.....	185
B-8.1	Recessed Troffers.....	185
B-8.2	Incandescent Downlights.....	185
B-8.3	Fluorescent Industrial Luminaires, Wraparound, and Strip Lights.....	185
B-8.4	HID, Floodlights, Downlights and Other Luminaires.....	186
B-8.5	Exit Signs.....	186
B-8.6	Lighting Control System.....	186
APPENDIX C	BEST PRACTICES: DAYLIGHTING.....	188
C-1	INTRODUCTION.....	188
C-2	SYSTEM INTEGRATION.....	188
C-3	CONTROLS.....	188

C-3.1	Daylight Sensor Technologies.	188
C-3.2	Automatic Lighting Controls.	189
C-3.3	Task Dominant Areas.	189
C-3.4	Non-Task Dominant Areas.....	190
C-3.5	Control Strategies.	190
C-4	AUTOMATED SHADING.	192
APPENDIX D BEST PRACTICES: EXTERIOR.....		194
D-1	LIGHTING QUALITY.....	194
D-1.1	Luminance.	194
D-1.2	Light Pollution.	194
D-1.3	Light Trespass.	195
D-2	LUMINAIRE CLASSIFICATION.....	197
D-2.1	BUG Rating System.....	198
D-3	LIGHTING ZONES.	201
D-3.1	LZ0 No Ambient Lighting.	201
D-3.2	LZ1 Low Ambient Lighting.	201
D-3.3	LZ2 Moderate Ambient Lighting.....	201
D-3.4	LZ3 Moderately High Ambient Lighting.....	201
D-3.5	LZ4 High Ambient Lighting.....	201
D-3.6	Considerations to Classify an Area at a Lower Lighting Zone.....	201
D-3.7	Considerations to Classify an Area at a Higher Lighting Zone.....	202
D-4	CONTROL APPROACHES.....	202
D-4.1	Manual Switching.....	202
D-4.2	Photocontrol.....	202
D-4.3	Occupancy Based Controls.	202
D-4.4	Adaptive Lighting.	202
D-5	CONTROL EQUIPMENT.....	203
D-5.1	Sensors.....	203
D-5.2	Time Clock.....	203
D-5.3	Network Control Systems.	203
APPENDIX E LIFE CYCLE COST ANALYSIS.....		206
E-1	ANALYSIS METRICS.	206
E-1.1	Net Present Value (NPV).	206

E-1.2	Internal Rate of Return (IRR).....	206
E-1.3	Payback.....	206
E-2	MAINTENANCE.....	206
APPENDIX F GLOSSARY.....		210

FIGURES

Figure 4-1. Example Lighting Zones on a Sample Installation	99
Figure 6-1. Example of controlled lighting: single fence line.....	135
Figure 6-2. Example of controlled lighting: double fence line	136
Figure 6-3. Example of glare projection: single fence line.....	137
Figure 6-4. Example of glare projection: double fence line.....	137
Figure 6-5. CCTV camera's view of scene with excessive glare	142
Figure B-1. Examples of direct glare	167
Figure B-2. Uniform ceiling brightness	168
Figure B-3. Uniform illuminance	168
Figure B-4. A change in furniture configuration affects the task plane illuminance uniformity	169
Figure B-5. Downlighting only results in spaces feeling dark and "cave-like". Lighting surfaces improves the feel of the space.....	170
Figure B-6. Example of the same space with downlighting only (left) and then with improved surface brightness (right).....	170
Figure B-7. Coverage Pattern of PIR Sensor	179
Figure B-8. Coverage Pattern of Ultrasonic Sensor	180
Figure B-9. Coverage Pattern of Dual Technology Sensor	181
Figure B-10, Typical Exit Sign	184
Figure C-1. Daylight Control Zones.....	191
Figure C-2. Daylight Control Zones with Obstructions (Upper Floors)	191
Figure C-3. Daylight Control Zones with Obstructions (Lower Floors)	192
Figure D-1. Los Angeles, 1908 (left), Los Angeles, 2002 (right).....	195
Figure D-2. Unshielded and non-cutoff luminaires lead to light pollution.....	195
Figure D-3. Examples of IES fully shielded luminaires.....	195
Figure D-4. Uncontrolled light source	196
Figure D-5. Fully shielded or IES fully shielded luminaires (left) are recommended. Do not use unshielded floodlights (right).....	196
Figure D-6. Exterior Luminaire BUG Classification	200

TABLES

Table 2-1. Interior Control Strategies.	7
Table 4-1. Lighting Zones and DoD Applications.	98
Table 4-2. Exterior Control Strategies.	100
Table 6-1. Minimum Lighting Criteria for Unaided Guard Visual Assessment.....	146
Table B-1. Summary of Control Strategies and Their Application	176
Table B-2. Recommended Control Devices for Different Building Applications.....	177
Table B-3. Lighting Control Energy Savings Examples by Application and Control Type	178
Table B-4. Guide for Using Sensors.....	182
Table C-1. Summary of Daylight Sensors	189
Table D-1. Exterior Luminaire Distribution Classification.....	198
Table D-2. NEMA Field Angle Classifications	198
Table D-3. Correlation between BUG Ratings and Cutoff Classifications	199
Table D-4: Exterior Luminaire BUG Classification Key.....	200
Table E-1: Life Cycle Cost Analysis Example	207

CHAPTER 1 INTRODUCTION

1-1 BACKGROUND.

Consistent with UFC program requirements, this document integrates unique DOD requirements with Federal mandates and industry standards for high performance lighting, both interior and exterior.

1-2 PURPOSE AND SCOPE.

This UFC provides requirements for the design of interior and exterior lighting systems and controls based on the Illuminating Engineering Society of North America's (IES) *Lighting Handbook Reference and Application, 10th Edition* (hereafter called *IES Lighting Handbook*), Energy Policy Act of 2005, and current recommended practices. This UFC meets the current IES standard of practice and addresses general lighting requirements for Department of Defense (DoD) facilities.

1-3 APPLICABILITY.

This document applies to all service elements and contractors designing interior or exterior lighting systems for construction, repair, and maintenance projects. This UFC establishes the baseline requirement for:

- Energy Efficiency
- Control strategy
- Lighting level

If not included in this document or facility type criteria, refer to the IES Lighting Handbook.

1-4 GENERAL BUILDING REQUIREMENTS.

Comply with UFC 1-200-01, *General Building Requirements*. UFC 1-200-01 provides applicability of model building codes and government-unique criteria for typical design disciplines and building systems, as well as for accessibility, antiterrorism, security, sustainability, and safety. Use this UFC in addition to UFC 1-200-01 and the UFCs and government criteria referenced therein.

Lighting systems must meet ASHRAE 90.1. Refer to UFC 1-200-02 for publication year of ASHRAE. Note that the requirements of this UFC refer to ASHRAE 90.1-2010. When UFC 1-200-02 adopts a newer publication year of ASHRAE 90.1 it will have precedence over these UFC requirements.

1-5 REFERENCES.

Appendix A contains a list of references used in this document. The publication date of the code or standard is not included in this document. In general, the latest available issuance of the reference is used.

1-6 GLOSSARY.

Appendix F contains acronyms, abbreviations, and terms.

CHAPTER 2 INTERIOR LIGHTING AND CONTROLS

2-1 PRIORITIES FOR LIGHTING SYSTEMS.

Design interior lighting systems to reduce energy consumption, reduce maintenance costs, improve lighting quality, at the lowest life cycle cost in DoD facilities.

2-1.1 Energy Reduction.

Reduce energy consumption by using energy efficient technologies, effective illuminance levels, and implementing control strategies.

2-1.2 Maintenance Reduction.

Reduce maintenance by technology selection, reducing equipment quantities, and implementing controls strategies.

Select light sources, power supplies, and controls that are rated and warranted for long useful lives to increase the amount of time between maintenance cycles. Minimize light source types on an individual project. Locate luminaires in locations to improve access for regular servicing such as light source replacement.

2-1.3 Lighting Quality.

Apply the following to ensure the priority of lighting quality is achieved.

2-1.3.1 Direct Glare.

Shield light sources in the luminaires with louvers, perforations, or lenses to avoid a view of the light sources and the resultant direct glare.

2-1.3.2 Reflected Glare.

Avoid reflected glare caused by using bright luminaire components such as visible light sources or bright lenses where they can reflect in the surface of tasks with glossy or specular finishes.

2-1.3.3 Luminances of Room Surfaces.

Illuminate surfaces to control the contrast between the occupant's task and the surrounding surface in that person's field of view. Avoid dark backgrounds when a person views a bright computer screen in the foreground. Control high luminance ratios for daylight fenestrations when direct sun is allowed to penetrate.

2-1.3.4 Uniformity.

Uniformly illuminate the task plane as well as room surfaces, to avoid shadows or distracting patterns of light.

2-1.3.5 Shadowing.

Minimize contrast with ambient and task lighting to fill in harsh shadows, especially for work surfaces where people are performing detail oriented tasks.

2-1.3.6 Color Appearance.

Accurately render the color of accent walls, architectural features, and artwork. Use LED, fluorescent, or ceramic metal halide light sources with a high color-rendering index (CRI).

2-1.3.7 Point(s) of Interest.

Focus attention and provide wayfinding with accent lighting. Create visual interest in special spaces as well as guidance through transitional areas with lighting and accenting signs.

2-1.3.8 Modeling of Faces or Objects.

Include indirect lighting from multiple directions and angles for ambient lighting. Use multiple systems such as sconces, pendants, and wall washers to ensure the proper appearance of three dimensional forms.

2-1.3.9 Source/Task Eye Geometry.

Locate luminaires in response to task areas to avoid shadows and direct and reflected glare.

2-1.3.10 Appearance of Space and Luminaires.

Use creative lighting with aesthetic appearance of the space and of the luminaires for public building areas.

2-1.3.11 Surface Characteristics.

Coordinate with the interior designer to select surface finishes that complement the lighting design.

2-1.4 Life Cycle Cost.

Refer to APPENDIX E for an example of a life cycle cost analysis (LCCA). The LCCA must provide a comparison to LED technology for applications where LED is a viable option. Exclude maintenance costs in all retrofit life cycle cost analyses that cannot be verified.

Select lighting systems on the total ownership cost accounting for the following variables:

- Initial Cost

- Energy Cost
- Demand Cost
- Utility Inflation Rate
- Maintenance (Equipment) Cost
- Maintenance (Labor) Cost (including cleaning of luminaire)
- Maintenance Inflation Rate
- Replacement Cost
- Disposal/Recycling Cost
- Annual Hours of Operation
- Lifetime (all systems must be capitalized twice in the analysis period but not to exceed 40 years.)

Note: For AF projects, For LED applications that do not have built-in failure detection in the luminaire, include labor costs to measure light levels (baseline and 70% output – before the end of the warranty) in the LCCA.

2-1.5 Lighting System Efficiencies.

Increases in Solid State Lighting (SSL)/Light Emitting Diode (LED) lighting system efficiencies are surpassing the efficiencies of linear fluorescent systems. Analyze the use of LED for interior applications.

2-2 LIGHTING CONTROLS.

Lighting control requirements must meet ASHRAE 90.1, ASHRAE 189.1 and this UFC. Refer to UFC 1-200-02 for publication year of ASHRAE. Refer to Chapter 3 (Interior Applications) for control requirements. Provide commissioning per ASHRAE requirements. Refer to IES DG-29 for commission guidance for specific applications.

2-2.1 Daylighting Control Requirements.

Control the electric lighting in response to daylight.

- Continuously dim electric light in task oriented areas such as offices, conference rooms, classrooms, or turning it off in non-task areas such as circulation and lounge areas.
- Control primary and secondary daylight zones separately. Refer to APPENDIX C Daylighting Best Practices for additional information.

2-2.1.1 Automated Shading.

When automated shading is provided to control glare and unwanted heat gain from daylighting, coordinate daylighting controls with automated shading controls.

2-2.2 Means of Egress.

Comply with NFPA 101 for the lighting and controls in Means of Egress.

2-2.3 Control Strategies.

Indicate in the contract documents the control strategy for each space in accordance with narrative descriptions in Table 2-1. Refer to Chapter 3 (Interior Applications) for additional information. In normally occupied spaces, control strategies must include a means for the occupant to manually turn the lights on and off.

Do not use occupancy sensors, vacancy sensors, or timers to control luminaires that provide illumination of the work space around electrical service equipment such as switchboards, panelboards, or motor control centers. To reduce energy consumption, luminaires in the adjacent space that do not provide illumination of the work space must be dimmable and controlled by an integrated or separate vacancy sensor. For this application, the luminaires can be dimmed a maximum of 50 percent of full light output and the dimming cannot be stepped.

Table 2-1. Interior Control Strategies.

Control Strategy Name	Control Strategy Description
Manual On/Manual Off	Occupant manually turns the lights on upon entering the space and occupant manually turns the lights off when exiting. This approach can only be used when other control strategies cannot be implemented due to operational requirements.
Manual On/Vacancy to 50% Off	Occupant manually turns the lights on upon entering the space and upon sensing vacancy, switch or dim luminaires to 50% of full light output.
Manual On/Vacancy Off	Occupant manually turns the lights on upon entering the space and upon sensing vacancy, the lights turn off.
Occupancy On/Vacancy Off	Occupant enters space and lights automatically turn on to 100% of full light output. Upon sensing vacancy, the lights turn off.
Occupancy 50% On/Manual Adjust/Vacancy Off	Occupant enters space and lights automatically turn on to 50% of full light output. Occupant can manually dim or switch the lights to a higher percentage of full light output. Upon sensing vacancy, the lights turn off.
Occupancy On/Daylight Adjust/Vacancy Off	Occupant enters space and lights automatically turn on to 100% of full light output. When sufficient daylight is available, lights switch or dim to a lower output. Upon sensing vacancy, the lights turn off.
Occupancy 50% On/Daylight Adjust/Vacancy Off	Occupant enters space and lights automatically turn to 50% of full light output. Occupant can manually dim or switch the lights to a higher percentage of full light output. When sufficient daylight is available, lights switch or dim to a lower output. Upon sensing vacancy, the lights turn off.
Timer On/Scene Adjust/Timer Off	Lights automatically turn on at a preset time of day. Personnel can manually adjust preset scenes. Lights automatically turn off at a preset time of day.
Timer On/Daylight Adjust/Timer Off	Lights automatically turn on at a preset time of day. When sufficient daylight is available, lights switch or dim to a lower output. Lights automatically turn off at a preset time of day.

* Regardless of control strategy, the controls and illumination for the means of egress components must comply with the requirements of NFPA 101.

2-2.4 Network Certification.

\1\ Network /1/ control systems (including systems separate from an energy management control system) must be planned, designed, acquired, executed, and maintained in accordance with DoD Instruction 8500.01 and DoD Instruction 8510.01, and as required by individual Service Implementation Policy. Coordinate wireless networks with base spectrum manager prior to specification in case of restrictions for wireless usage within the installation.

Note: For AF projects, refer to ETL 11-1 for additional requirements.

2-3 DAYLIGHTING.

Refer to UFC 1-200-02 for Daylighting requirements. Coordinate architectural daylight design and lighting contribution into electrical lighting design and control.

Refer to APPENDIX C in this UFC for daylighting best practices.

2-4 EQUIPMENT.

2-4.1 Light Source Technology.

Use a correlated color temperature (CCT) of no greater than 4100K as stated on the manufacturer's cutsheet for all interior spaces. Do not mix source CCTs within a single building with the purpose of minimizing maintenance staff from having to keep track of specific CCTs. The different CCTs will cause visual confusion. Maintain one CCT source. Use a color rendering index (CRI) of no less than 80 for interior applications.

Note, per ANSI C78.377-2011 standard, nominal CCT of 4000K is 3985K +/-275K for SSL products.

2-4.1.1 Solid State Lighting.

- LED luminaires must be dimmable or capable of multi-level control according to the control strategy.
- \1\ SSL dimmers must be NEMA SSL 7A¹ compliant to ensure that the electrical infrastructure is adequate to dim the lamps without flicker or drop outs in dimming range. /1/
- LED light source replacements (screw base) are only permitted for the replacement of incandescent or compact fluorescent light sources.
- IES LM-79, LM-80, and TM-21 testing reports must be supplied from manufacturer and include all relevant information.

¹ Department of Energy. *Dimming LEDs with Phase-Cut Dimmers: The Specifier's Process for Maximizing Success*. October 2013.

- Consistent with industry standard, all LED luminaires require a 10-year warranty.

Note: For AF projects, For LED applications, provide built in failure detection in the luminaire or include labor costs to measure light levels (baseline and 70% output - before the end of the warranty) in the LCCA. \2\

2-4.1.1.2 Linear LED Lamps

- \3\3/
- Do not use linear LED lamps with luminaire conversion kits.
- \3\3/. /2/

2-4.1.2 Compact Fluorescent Light (CFL).

- Do not use CFL sources less than 13 watts.
- Do not use u-bent fluorescent light sources.
- Do not use in cold temperature environments (colder than 50 degrees Fahrenheit), except where alternatives such as SSL are unavailable.

2-4.1.3 Linear Fluorescents.

- Do not use T12 light sources.
- Do not use in cold temperature environments (colder than 50 degrees Fahrenheit), except where alternatives such as SSL are unavailable.

2-4.1.4 Induction (Electrodeless Fluorescent).

- All induction light sources must be dimmable.

2-4.1.5 Metal Halide.

- No restrictions.

2-4.1.6 Mercury Vapor.

- Do not use mercury vapor light sources.

2-4.1.7 High and Low Pressure Sodium.

- Do not use for interior applications.

2-4.1.8 Incandescent and Tungsten Halogen.

- Do not use incandescent or tungsten halogen light sources, except where alternatives such as SSL are unavailable.

2-4.2 Ballasts, Drivers, Generators, and Power Supplies.

2-4.2.1 Solid State.

- Total current harmonic distortion (THD) less than or equal to 20% \1\ at full and 50% output. /1/
- Power factor (PF) greater than or equal to 0.9 \1\ at full and 50% output. /1/.
- For current and future dimming requirements (i.e. smart grid, curfew, adaptive), use dimmable or bi-level drivers compatible with standard dimming control circuit of 0-10V. Other dimming protocols must comply with Network Certification requirements.

2-4.2.2 Linear Fluorescent.

- Provide dimmable or bi-level ballasts in spaces.
- Use programmed start ballasts with end of life protection.
- NEMA premium electronic ballasts must be specified where applicable.
- Do not use instant start ballasts.

2-4.2.3 Compact Fluorescent.

- Provide dimmable ballasts.
- Provide programmed start ballasts for compact fluorescent light sources that include end of life protection.

2-4.2.4 High Intensity Discharge.

- Power factor (PF) greater than or equal to 0.9.
- Provide electronic ballasts for all available wattages.

2-4.3 Surge Protection Device (SPD).

- Provide metal oxide varistor (MOV) type SPDs at panel boards for all circuits feeding interior lighting systems.

2-5 ELECTRICAL ENERGY MONITORING.

For new construction of buildings greater than 25,000 SF (2,322 m²), terminate lighting branch circuits in dedicated lighting panelboards.

2-6 ELEVATORS.

Provide lighting for elevators in accordance with ASME A17.1 or ASME A17.3 as applicable.

2-7 ILLUMINATION FOR MEANS OF EGRESS.

Provide in accordance with NFPA 101.

2-7.1 Emergency Lighting.

- Emergency lighting units must be LED for new construction. It is not life cycle cost effective to replace existing units.
- Install emergency lighting equipment in conspicuous and accessible locations to facilitate the periodic testing requirements.

2-7.2 Exit Signs.

- Internally illuminated signs must be LED type and comply with UFC 3-600-01.

\1\

2-8 LIGHTING SYSTEM ALTERATIONS.

Lighting system alterations must meet AHSRAE 90.1 and this UFC. ASHRAE 90.1 states that the alteration of lighting systems in any building space or exterior area must comply with the lighting power density (LPD) requirements applicable to that space or area and the automatic shutoff requirements. Such alterations include all luminaires that are added, replaced or removed. This requirement must also be met for alterations that involve only the replacement of lamps plus ballasts.

Most spaces require less illuminance with modern tasks than were required when the existing lighting systems were installed. Therefore, to maximize long term energy and sustainment savings and to improve the lighting quality in existing spaces, designers must first consider a redesign before luminaire replacement, conversion or retrofit. This includes the implementation of controls which will provide long term energy and sustainment savings. Refer to LEM-3 *IES Guidelines for Upgrading Lighting Systems in Commercial and Institutional Spaces* for additional information. All lighting systems alterations must be supported by a Life Cycle Cost Analysis (LCCA) in accordance with UFC 1-200-02.

2-8.1 LIGHTING SYSTEM ALTERATION PRIORITIES.

Lighting system alteration priorities are the same as a new system:

1. Reduce energy through technology selection, providing appropriate illuminance levels and implementing control strategies.
2. Reduce maintenance through reduction in equipment quantities (luminaires), technology selection and implementing control strategies.
3. Improve lighting quality through technology selection, improved photometric distribution, and glare reduction. /1/

2-8.2 REDESIGN.

Redesign includes new luminaires, circuits, and controls designed to meet current lighting criteria \1V1/. The design must ensure reduced energy consumption, reduced maintenance, and improved lighting quality at the lowest life cycle cost. \1V1/ Redesign lighting systems when the existing:

- Illuminance levels are too low or too high
- Lighting produces \1\ excessive /1/ glare
- Lighting does not illuminate perimeter surfaces (in offices) or shelving (in warehouses and storage)
- Luminaire layout produces uneven illumination
- Luminaire spacing is too wide, or partition height obstructs light distribution
- Luminaires (or luminaire layout) is not appropriate because the tasks or physical layout of the space has changed
- Luminaires are in poor condition
- Hazards are present

\1\

2-8.3 LUMINAIRE REPLACEMENT AND CONVERSION.

Luminaire replacement or conversion may only extend the life of deficient or substandard systems. Therefore, a luminaire replacement or conversion is only acceptable when the resulting illuminance level, glare, distribution and controls meet the current criteria, is supported by the LCCA, and complies with the following:

1. Correlated Color Temperature (CCT) of not greater than 4100K as stated on the manufacturer's data sheet

2. Color Rendering Index (CRI) of not less than 80
3. Total current Harmonic Distortion (THD) less than or equal to 20% at full and 50% output
4. Power Factor (PF) greater than or equal to 0.9 at full and 50% output
5. Inrush current meets NEMA 410
6. Compatible with NEMA SSL 7A dimmers and dimming systems
7. If existing luminaires are on a dimmer or dimming system, provide a compatible dimmer or dimmer system. Dimmer or dimming systems must be NEMA SSL 7A compliant to ensure that the electrical infrastructure is adequate to dim the light source without flicker or drop outs within the dimming range.
8. Submittals must contain:
 - a. Product Data
 - i. IESNA LM-79, Approved Method for the Electrical and Photometric Measurements of Solid-State Lighting Products. Test report must include a picture of the fixture tested.
 - ii. IESNA LM-80, Approved Method for Measuring Lumen Maintenance of LED Light Sources Test Report
 - iii. IESNA TM-21, Projecting Long Term Lumen Maintenance of LED Light Sources calculation based on the IESNA LM-80 data.
 - iv. Certification from the manufacturer indicating compliance with NEMA 410.
 - v. Photometric Plan: Computer generated photometric analysis of the designed-to values for the “end of useful life” of the lighting system based on IESNA LM-79 data.

2-8.3.1 Luminaire Conversion Kit.

Luminaire conversion kit is a system that replaces the existing luminaire components to include the ballast, lamp, reflector, wiring and the diffusers when required. Direct replacement of an incandescent, fluorescent, induction, or HID lamp to LED lamp, without any electrical or mechanical changes, is not considered to be a luminaire conversion. In addition, luminaire conversion kits must meet the following:

1. UL 1598C Standard for Light-Emitting Diode (LED) Retrofit Luminaire Conversion Kits. UL1598 kits are intended to replace existing light sources and systems in previously installed luminaires that comply with the requirements in the Standard for Luminaires, UL 1598. UL 1598C kits are intended for use on:

- a. Luminaires where specific luminaire model or part numbers are identified in the kit installation instructions; or
 - b. One or more generic type luminaires that meet specific criteria identified in the installation kit instructions
2. Minimum efficacy of 120 lumens per watt
 3. Lumen depreciation greater than or equal to L70 at 50,000 hours
 4. Resulting system must produce light levels equivalent to the existing system or meet the lighting levels required in the current criteria
 5. Additional submittals that must be provided:
 - a. Product Data:
 - i. IESNA LM-79, Approved Method for the Electrical and Photometric Measurements of Solid-State Lighting Products Test report for each existing fixture type to be converted with the luminaire conversion kit to be provided. Test report must include a picture of the fixture tested.
 - b. Warranty:
 - i. Written five year unconditional warranty for material. Material warranty shall include replacement when more than 10% of LED sources are defective or non-starting, when the light output of the lamp drops below 70% of the initial lumens, or when there is a noticeable color shift.

2-8.4 LIGHT SOURCE RETROFIT.

Light source retrofit; sometimes referred to as a direct replacement, is a system designed in the same form factor as the existing light source intended to replace the existing light source within the luminaire. An example is a linear LED lamp, sometimes referred to as tubular LED (TLED) that is a direct replacement for a linear fluorescent lamp.

As with luminaire replacement or conversion, a light source retrofit may only extend the life of deficient or substandard system. Do not use LED retrofit light sources or LED lighting modules that have been designed and constructed to be installed in existing HID or mercury vapor luminaire enclosures. LED retrofits are approved for replacement of CFL or incandescent sources (A-Type lamp replacements with Edison bases). Warning: inserting a LED retrofit in an existing luminaire may void the luminaire's warranty. \3\ Linear LED lamp retrofits are allowed /3/ with the following criteria:

1. Underwriters Laboratories (UL) \3\ 1993 /3/ Type A Certification.

- a. Type A is designed to operate with the existing fluorescent ballast and does not require mechanical or electrical changes to the fixture. Dual Mode Lamps (UL Type A/Type B) designed to operate off the existing fluorescent ballast and line voltage are not acceptable.
2. Compatible with existing ballast type. Do not bypass or remove the ballast of the existing luminaire. \3\ If the linear LED lamps are not compatible with the existing ballast, the existing ballast may be replaced with a compatible fluorescent lamp ballast suitable for ASHRAE 90.1 compliant lighting controls. /3/
3. Be manufactured within one year of installation
4. Dimmable
5. Frosted or diffuse-optic with a minimum beam angle of 180 degrees
6. Correlated Color Temperature (CCT) of not greater than 4100K as stated on the manufacturer's data sheet
7. Color Rendering Index (CRI) of not less than 80
8. Total current Harmonic Distortion (THD) less than or equal to 20% at full and 50% output
9. Power Factor (PF) greater than or equal to 0.9 at full and 50% output
10. Minimum efficacy of 100 lumens per watt
11. Lumen depreciation greater than or equal to L70 at 40,000 hours
12. Resulting system must produce light levels equivalent to the existing system or meet the lighting levels required in the current criteria.
13. Additional submittals that must be provided:
 - a. Product Data:
 - i. IESNA LM-79, Approved Method for the Electrical and Photometric Measurements of Solid-State Lighting Products Test report for each existing fixture type being retrofitted with the linear LED lamp to be provided. Test report must include a picture of the fixture tested.
 - b. Warranty:
 - i. Written five year unconditional warranty for material. Material warranty shall include replacement when more than 10% of LED sources are defective or non-starting, when the light output of the lamp drops below 70% of the initial lumens, or when there is a noticeable color shift. /1/

This Page Intentionally Left Blank

CHAPTER 3 INTERIOR APPLICATIONS

3-1 INTRODUCTION.

This chapter identifies typical interior facility applications. Each application details a conceptual lighting design example. The requirements for each application are for general ambient lighting. Coordinate accent and specialty lighting with architect and interior designer. Designs must meet the lighting performance and controls requirements defined in the application details.

Verify special lighting equipment requirements in hazardous (classified) locations.

3-2 LIGHTING CALCULATIONS.

Computer-generated photometric plans for each space are required to verify proposed luminaires and locations meet the required performance criteria of the design using \1\ the applicable light loss factor (LLF)./1/ Photometric plan submittals must include:

- Horizontal illuminance measurements at workplane or other designated height above finished floor, taken at a maximum of every one foot (305mm).
- Minimum and maximum illuminance levels.
- Average maintained illuminance level.
- Average to minimum and maximum to minimum ratios for horizontal illuminance.
- Lighting power density (Watts per square foot or per square meter).
- \1\ LLF /1/

3-3 GENERAL BUILDING SPACES.

3-3.1 Corridors.

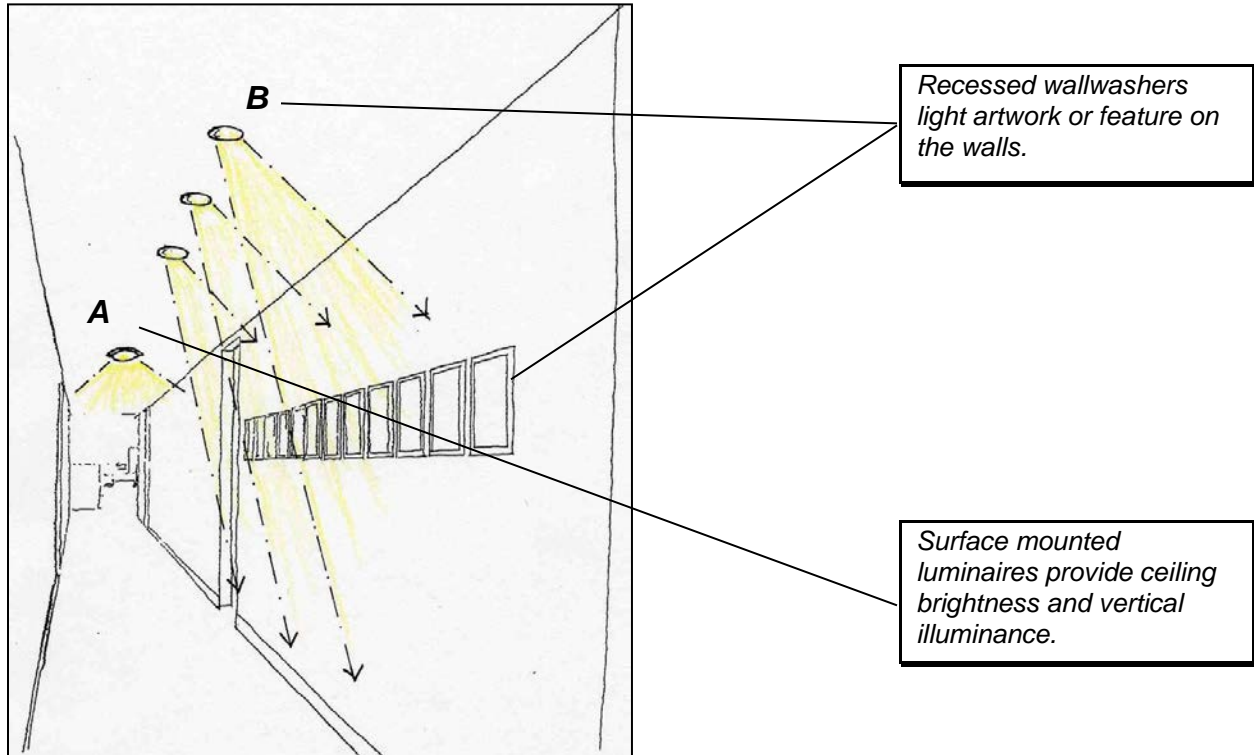

EQUIPMENT REQUIREMENTS:

	LUMINAIRE	LIGHT SOURCE	CONTROLS per ASHRAE (refer to General Building Requirements for clarification)
A	Surface mounted luminaires.	LED or fluorescent.	Automatic on to full design lighting power when occupant activity is sensed. Automatically reduce light output by at least 50% when no occupant activity is detected. General lighting in daylighted areas separately controlled through multilevel photocontrol (step dimming or continuous dimming) to reduce light output when daylight is available, with at least one control step between 50% and 70% of design lighting power and one control step that is no greater than 35% (including off) of design lighting power.
B	Recessed downlight / wallwashers.	LED or fluorescent.	Automatic on to full design lighting power when occupant activity is sensed. Automatically reduce light output by at least 50% when no occupant activity is detected.
B ALT	Recessed linear downlight / wallwashers.	LED or fluorescent.	

PERFORMANCE REQUIREMENTS:

Target Criteria	Daytime	Nighttime
<i>Horizontal Illuminance (Average $\pm 10\%$)</i>	<i>5 fc (50 lux) at floor</i>	
<i>Vertical Illuminance (Average $\pm 10\%$)</i>	<i>3 fc (30 lux) at 5'-0" (1524mm) AFF</i>	
<i>Horizontal Illuminance Uniformity</i>	<i>2:1 average to minimum</i>	

CRITICAL DESIGN ISSUES:

- Means of egress must comply with NFPA 101.

3-3.2 Stairways.

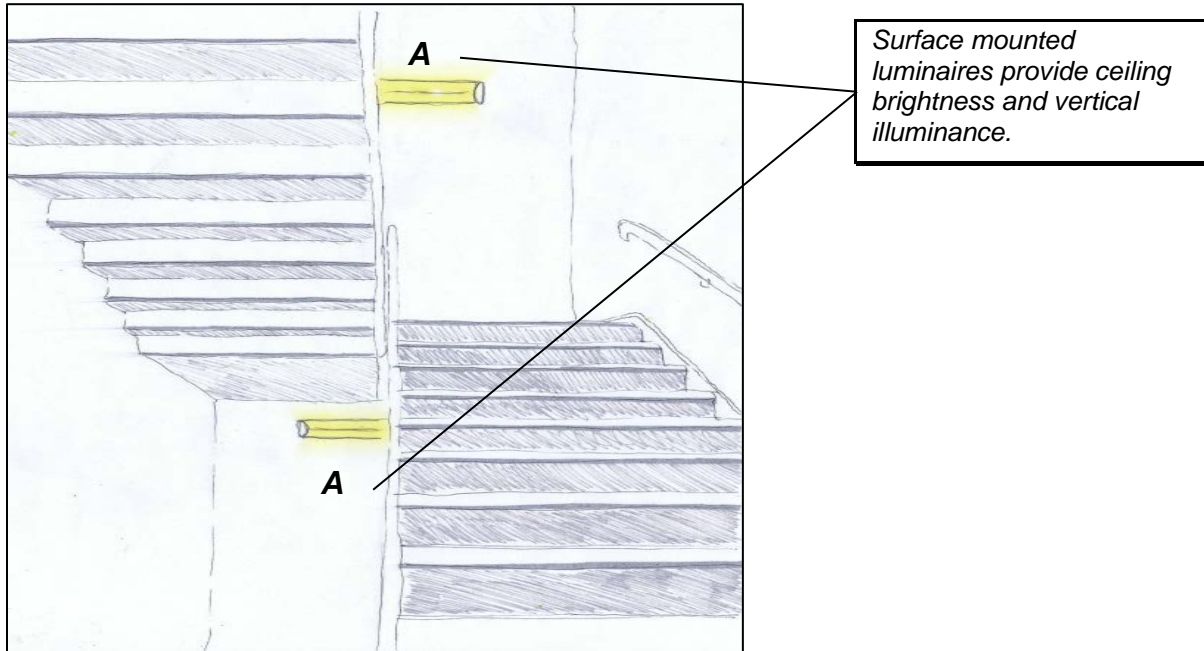

EQUIPMENT REQUIREMENTS:

	LUMINAIRE	LIGHT SOURCE	CONTROLS per ASHRAE (refer to General Building Requirements for clarification)
A	<i>Surface mounted luminaires</i>	<i>LED or fluorescent.</i>	<i>Automatic on to full design lighting power when occupancy is sensed. Automatically switch or dim to 50% of full light output when vacancy is sensed.</i>

PERFORMANCE REQUIREMENTS:

Target Criteria	Daytime	Nighttime
<i>Horizontal Illuminance (Minimum ±10%)</i>	<i>10 fc (100 lux) at walking surface</i>	
<i>Vertical Illuminance (Average ±10%)</i>	<i>3 fc (30 lux) at 5'-0" (1524mm) AFF</i>	
<i>Horizontal Illuminance Uniformity</i>	<i>2:1 average to minimum</i>	

CRITICAL DESIGN ISSUES:

- Locate luminaires where they are easily accessible for maintenance.
- Refer to NFPA 101 requirements for controls and performance requirements.

3-3.3 Lounge Areas.

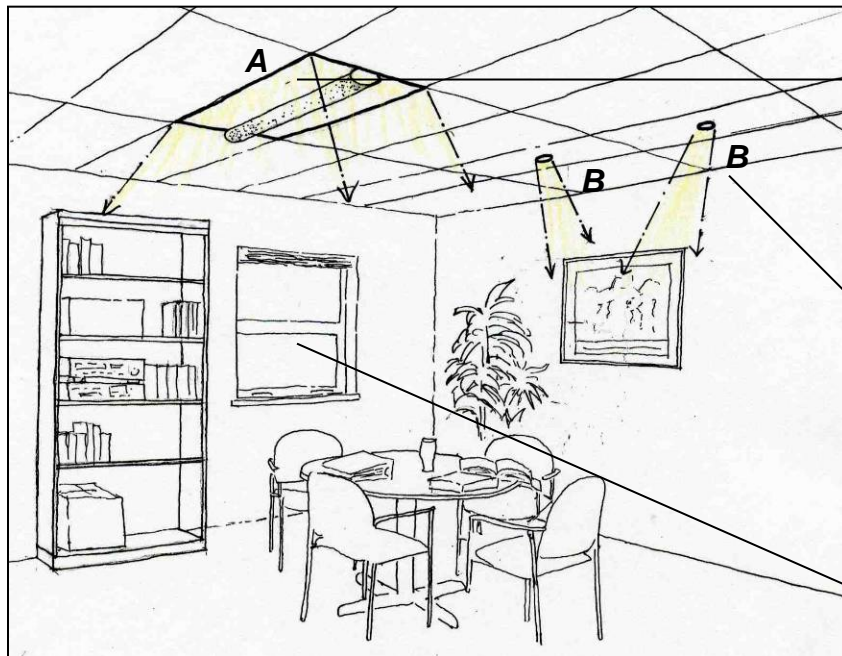

Recessed direct / indirect luminaires provide ambient light and some ceiling brightness.

Wallwashing and accent lighting increases room surface brightness and highlights artwork and features.

Introduce and control daylight. Integrate with electric light controls to reduce energy use.

EQUIPMENT REQUIREMENTS:

	LUMINAIRE	LIGHT SOURCE	CONTROLS per ASHRAE (refer to General Building Requirements for clarification)
A	<i>Recessed direct / indirect linear luminaire.</i>	<i>LED or fluorescent.</i>	<p><i>Manual on, or auto on (to no more than 50% design lighting power) combined with manual on switching, when occupant enters room.</i></p> <p><i>General lighting in daylighted areas separately controlled through multilevel photocontrol (step dimming or continuous dimming) to reduce light output when daylight is available, with at least one control step between 50% and 70% of design lighting power and one control step that is no greater than 35% (including off) of design lighting power.</i></p> <p><i>Provide manual control device to independently control general lighting with at least one control step between 30% and 70% of design lighting power in addition to all off.</i></p> <p><i>Automatic off within 15 minutes of no occupant activity.</i></p>
B	<i>Recessed downlight / wallwasher.</i>	<i>LED or fluorescent.</i>	<p><i>Manual on, or auto on (to no more than 50% design lighting power) combined with manual on switching, when occupant enters room.</i></p> <p><i>Automatic off within 15 minutes of no occupant activity.</i></p>

PERFORMANCE REQUIREMENTS:

Target Criteria	Daytime	Nighttime
<i>Horizontal Illuminance (Average $\pm 10\%$)</i>	<i>15 fc (150 lux) at 2'-6" (762mm) AFF</i>	
<i>Vertical Illuminance (Average $\pm 10\%$)</i>	<i>5 fc (50 lux) at 2'-6" (762mm) AFF</i>	
<i>Horizontal Illuminance Uniformity</i>	<i>2:1 average to minimum</i>	

3-3.4 Storage Rooms.

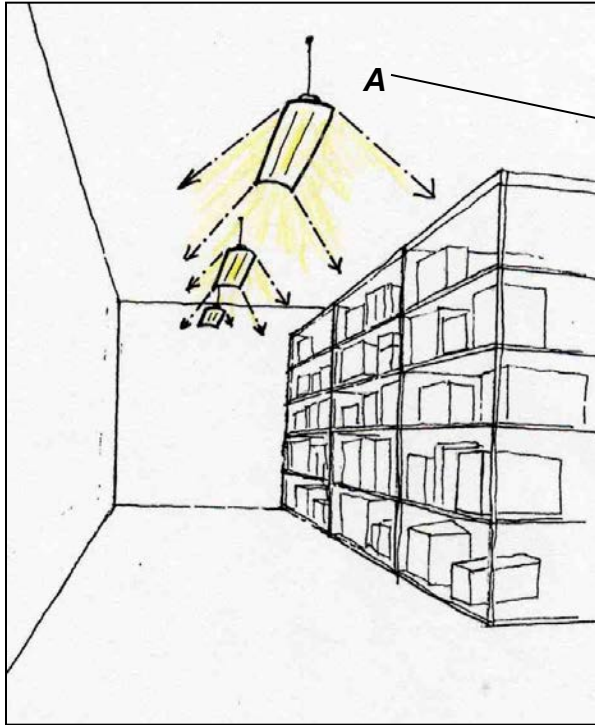

Linear industrial strips with a small uplight component illuminate shelves with minimal shadowing.

EQUIPMENT REQUIREMENTS:

	LUMINAIRE	LIGHT SOURCE	CONTROLS per ASHRAE (refer to General Building Requirements for clarification)
A	<i>Suspended or surface mounted linear luminaire.</i>	<i>LED, fluorescent, or induction.</i>	<i>Manual on, or auto on (to no more than 50% design lighting power) combined with manual on switching, when occupant enters room. Automatic off within 15 minutes of no occupant activity.</i>

PERFORMANCE REQUIREMENTS:

Target Criteria	Daytime	Nighttime
<i>Horizontal Illuminance (Average ±10%)</i>	<i>10 fc (100 lux) at floor</i>	
<i>Vertical Illuminance (Average ±10%)</i>	<i>3 fc (30 lux) at 4'-0" (1219 mm) AFF</i>	
<i>Horizontal Illuminance Uniformity</i>	<i>3:1 average to minimum</i>	

3-3.5 Mechanical Rooms.

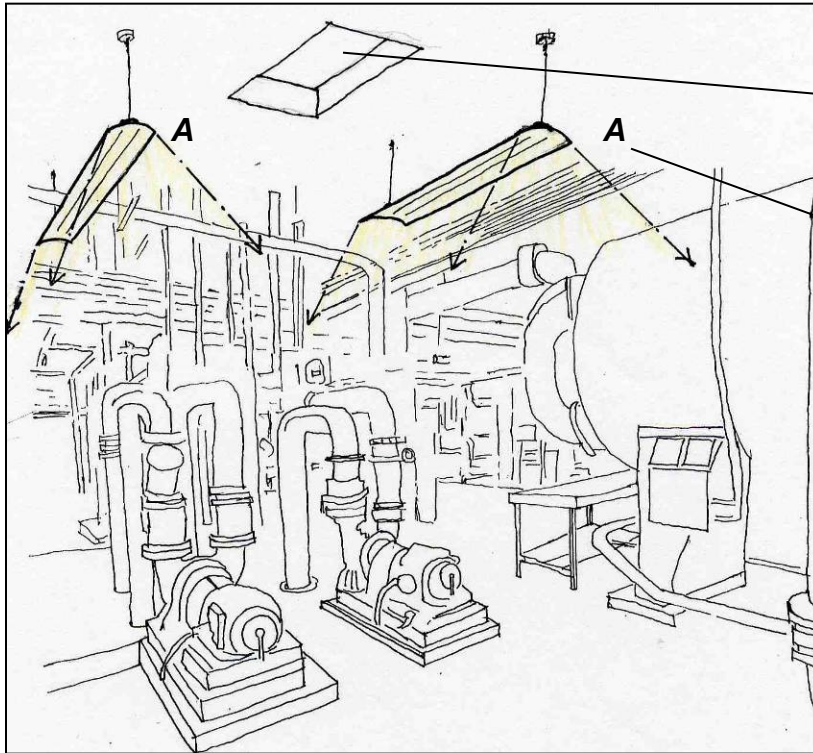

Consider daylight with toplighting strategies or clerestories.

Located to avoid mechanical equipment and minimize shadowing.

EQUIPMENT REQUIREMENTS:

	LUMINAIRE	LIGHT SOURCE	CONTROLS per ASHRAE (refer to General Building Requirements for clarification)
A	<i>Suspended linear industrial luminaire with 5%-10% uplight component.</i>	<i>LED or fluorescent.</i>	<i>Manual on. Manual off.</i>

PERFORMANCE REQUIREMENTS:

Target Criteria	Daytime	Nighttime
<i>Horizontal Illuminance (Average ±10%)</i>	<i>20 fc (200 lux) at 3'-6" (1067mm) AFF</i>	
<i>Vertical Illuminance (Average ±10%)</i>	<i>5 fc (50 lux) at 3'-6" (1067mm) AFF</i>	
<i>Horizontal Illuminance Uniformity</i>	<i>3:1 average to minimum</i>	

3-3.6 Restrooms.

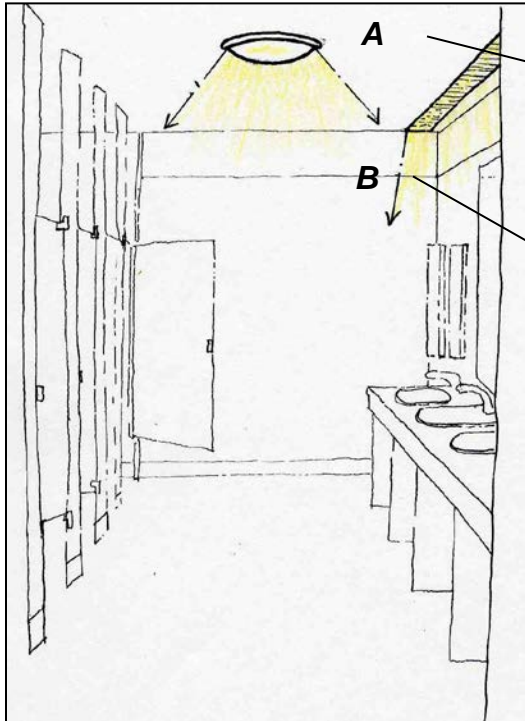

Surface mounted luminaires provide surface brightness on the ceiling.

Light at the mirror helps to illuminate faces.

EQUIPMENT REQUIREMENTS:

	LUMINAIRE	LIGHT SOURCE	CONTROLS per ASHRAE (refer to General Building Requirements for clarification)
A	Surface or wall mounted luminaire.	LED or fluorescent.	Automatic on to full design lighting power when occupant activity is sensed. Automatic off within 15 minutes of no occupant activity.
B	Recessed linear wall slot.	LED or fluorescent.	

PERFORMANCE REQUIREMENTS:

Target Criteria	Daytime	Nighttime
Horizontal Illuminance (Average $\pm 10\%$)	5 fc (50 lux) (general illuminance) 15 fc (150 lux) (fixtures and vanities) 10 fc (100 lux) (showers)	
Vertical Illuminance (Average $\pm 10\%$)	3 fc (30 lux) at 3'-0" to 5'-0" (914-1524 mm) AFF (general illuminance) 20 fc (200 lux) at 3'-0" to 5'-0" (914-1524 mm) AFF (vanities) 5 fc (50 lux) at 3'-0" to 5'-0" (914-1024 mm) AFF (fixtures and showers)	
Horizontal Illuminance Uniformity	2:1 average to minimum	

3-3.7 Telecommunication Room.

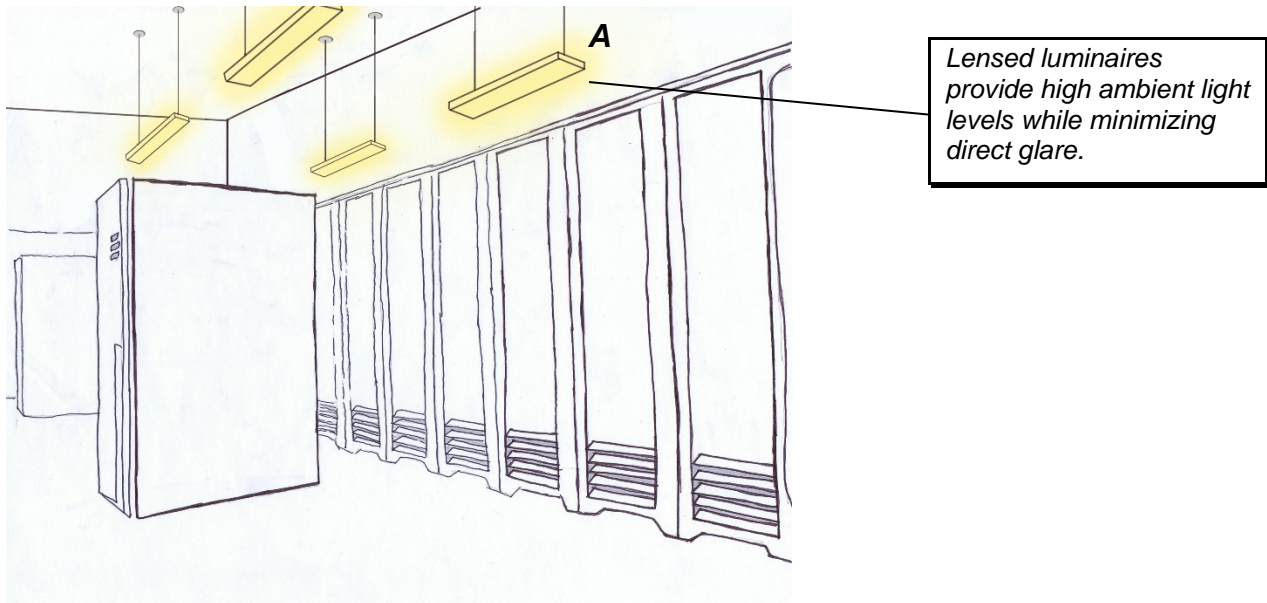

EQUIPMENT REQUIREMENTS:

	LUMINAIRE	LIGHT SOURCE	CONTROLS
A	<i>Pendant mounted linear luminaire.</i>	<i>LED or fluorescent.</i>	<i>Manual on Manual off</i>

PERFORMANCE REQUIREMENTS:

Target Criteria	Daytime/Nighttime
<i>Horizontal Illuminance (Minimum ±10%)</i>	<i>50 fc (500 lux) at 3'-0" (914mm) AFF</i>
<i>Vertical Illuminance (Minimum ±10%)</i>	<i>20 fc (200 lux) at 3'-0" (914mm) AFF</i>
<i>Horizontal Illuminance Uniformity</i>	<i>3:1 average to minimum</i>

3-4 ADMINISTRATIVE SPACES.

3-4.1 Large Lobbies.

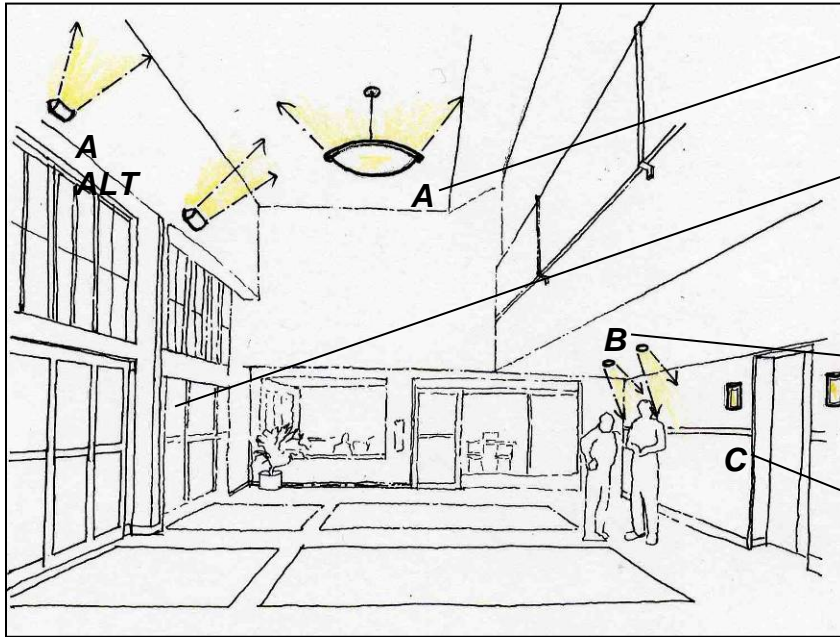

Suspended uplights provide ceiling brightness on high ceilings.

Introduce daylight and control glare. Integrate with electric lighting system.

Wallwashers provide surface brightness.

Wall sconces highlight features.

EQUIPMENT REQUIREMENTS:

	LUMINAIRE	LIGHT SOURCE	CONTROLS per ASHRAE (refer to General Building Requirements for clarification)
A	Suspended decorative luminaire.	LED or fluorescent.	Automatic on to full design lighting power within 15 minutes of normal opening. General lighting in daylighted areas separately controlled through multilevel photocontrol (step dimming or continuous dimming) to reduce light output when daylight is available, with at least one control step between 50% and 70% of design lighting power and one control step that is no greater than 35% (including off) of design lighting power. Automatic off within 15 minutes of closing. The occupant must be able to override any time-of-day scheduled shutoff control for no more than two hours.
A ALT	Wall mounted uplight.	LED, fluorescent, or metal halide light sources.	
B	Recessed wallwasher.	LED or fluorescent light source.	Automatic on to full design lighting power within 15 minutes of normal opening. Automatic off within 15 minutes of closing. The occupant must be able to override any time-of-day scheduled shutoff control for no more than two hours.

C	<i>Wall mounted sconce.</i>	<i>LED or fluorescent.</i>	<i>Automatic on to full design lighting power within 15 minutes of normal opening. Automatic off within 15 minutes of closing. The occupant must be able to override any time-of-day scheduled shutoff control for no more than two hours.</i>
----------	-----------------------------	----------------------------	--

PERFORMANCE REQUIREMENTS:

Target Criteria	Daytime	Nighttime
<i>Horizontal Illuminance (Average ±10%)</i>	<i>10 fc (100 lux) at floor</i>	<i>5 fc (50 lux) at 5'-0" (1524mm) AFF</i>
<i>Vertical Illuminance (Average ±10%)</i>	<i>5 fc (30 lux) at floor</i>	<i>2 fc (20 lux) at 5'-0" (1524mm) AFF</i>
<i>Horizontal Illuminance Uniformity</i>	<i>3:1 average to minimum</i>	

CRITICAL DESIGN ISSUES:

- Avoid visual clutter by selecting luminaires that are aesthetically pleasing.
- Eliminate harsh shadows by lighting surfaces within the space.
- Provide wayfinding guidance such as path to reception desk and elevators.
- Light room surfaces to balance out luminance ratios.

3-4.2 Individual Offices.

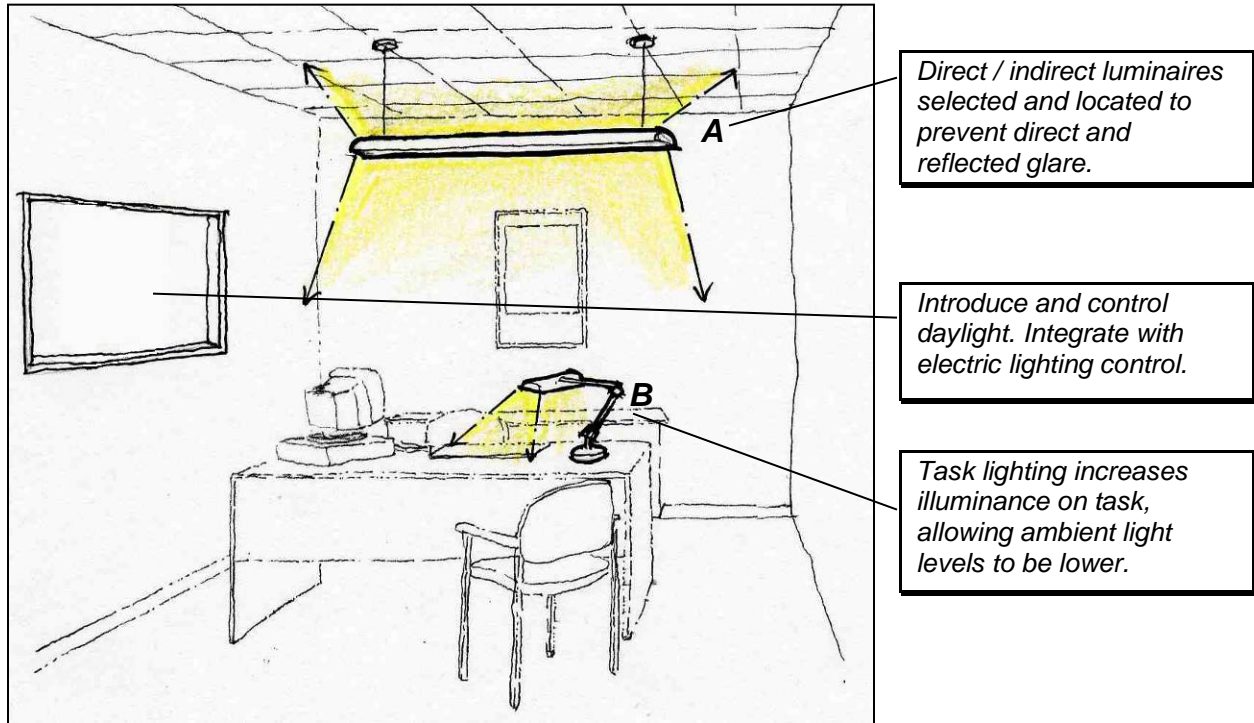

EQUIPMENT REQUIREMENTS:

	LUMINAIRE	LIGHT SOURCE	CONTROLS per ASHRAE (refer to General Building Requirements for clarification)
A	<i>Suspended linear, indirect / direct luminaire, mounted 18" – 36" (457 – 914mm) below ceiling. (There are some luminaires available for ceiling heights of 8' (2438mm).)</i>	<i>LED or fluorescent.</i>	<i>Manual on when occupant enters room. General lighting in daylighted areas separately controlled through multilevel photocontrol (step dimming or continuous dimming) to reduce light output when daylight is available, with at least one control step between 50% and 70% of design lighting power and one control step that is no greater than 35% (including off) of design lighting power. Provide manual control device to independently control general lighting with at least one control step between 30% and 70% of design lighting power in addition to all off. Automatic off within 15 minutes of occupant leaving room.</i>
B	<i>Task light.</i>	<i>LED, compact, or linear T8 fluorescent light source.</i>	<i>Control device integral to luminaire or controlled by wall mounted control device. Manual on or auto on (to no more than 50% power) combined with manual on switching, when occupant enters space. Automatic off within 5 minutes after occupant leaves space.</i>

PERFORMANCE REQUIREMENTS:

Target Criteria	Daytime	Nighttime
<i>Horizontal Illuminance (Average $\pm 10\%$)</i>	<i>30 fc (300 lux) at 2'-6" (762mm) AFF</i>	
<i>Vertical Illuminance (Average $\pm 10\%$)</i>	<i>15 fc (150 lux) at 3'-6" (1067mm) AFF</i>	
<i>Horizontal Illuminance Uniformity</i>	<i>2:1 average to minimum</i>	

3-4.3 Individual Offices (Alternate Scheme).

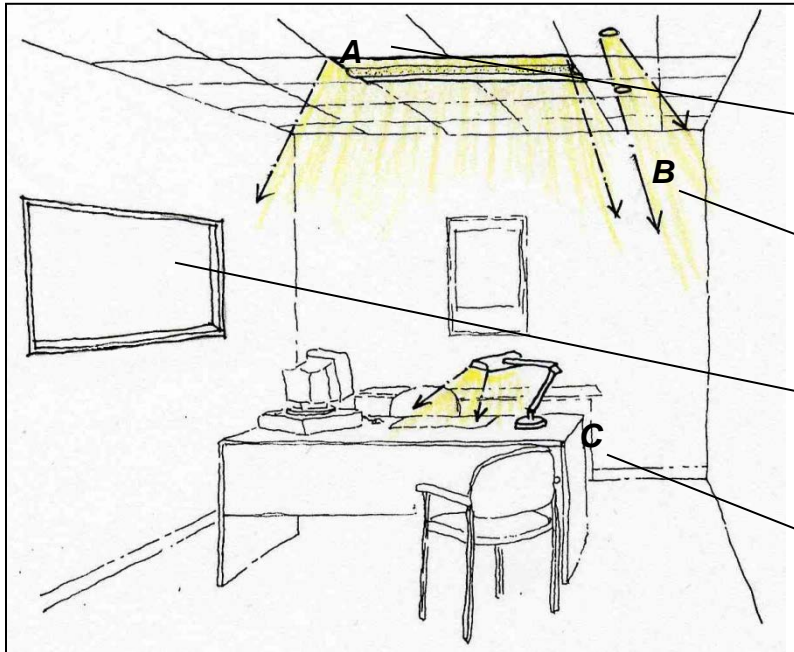

Recessed direct / indirect luminaire.

Recessed wallwashers light artwork to add wall brightness.

Introduce and control daylight. Integrate with electric lighting control.

Task lighting increases illuminance on task, allowing ambient light levels to be lower.

EQUIPMENT REQUIREMENTS:

	LUMINAIRE	LIGHT SOURCE	CONTROLS per ASHRAE (refer to General Building Requirements for clarification)
A	<i>Recessed linear direct/indirect luminaire.</i>	<i>LED or fluorescent.</i>	<i>Manual on to 70% (or lower) when occupant enters room. General lighting in daylighted areas separately controlled through multilevel photocontrol (step dimming or continuous dimming) to reduce light output when daylight is available, with at least one control step between 50% and 70% of design lighting power and one control step that is no greater than 35% (including off) of design lighting power. Provide manual control device to independently control general lighting with at least one control step between 30% and 70% of design lighting power in addition to all off. Automatic off within 15 minutes of occupant leaving room.</i>
B	<i>Recessed downlight / wallwasher.</i>	<i>LED or fluorescent.</i>	<i>Manual on to 70% (or lower) when occupant enters room. Reduce light output automatically when daylight is available through multilevel photocontrol (step dimming or continuous dimming), with at least one control step between 30% and 70% of design lighting power and one control step that is no greater than 35% (including off) of design power. Provide manual control device with at least one control step between 30% and 70% of design lighting power in addition to all off. Automatic off within 15 minutes of occupant leaving room.</i>
C	<i>Task light.</i>	<i>LED, or fluorescent.</i>	<i>Control device integral to luminaire or controlled by wall mounted control device. Manual on (to 70% or lower), or auto on (to no more than 50% power) combined with manual on switching, when occupant enters space. Automatic off within 5 minutes after occupant leaves space.</i>

PERFORMANCE REQUIREMENTS:

Target Criteria	Daytime	Nighttime
<i>Horizontal Illuminance (Average ±10%)</i>	<i>30 fc (300 lux) at 2'-6" (762mm) AFF</i>	
<i>Vertical Illuminance (Average ±10%)</i>	<i>15 fc (150 lux) at 3'-6" (1067mm) AFF</i>	
<i>Horizontal Illuminance Uniformity</i>	<i>2:1 average to minimum</i>	

CRITICAL DESIGN ISSUES:

- Minimize glare with solutions such as diffuse lens or shielded louvers.
- Light room surfaces to balance out luminance ratios.

3-4.4 Open Offices.

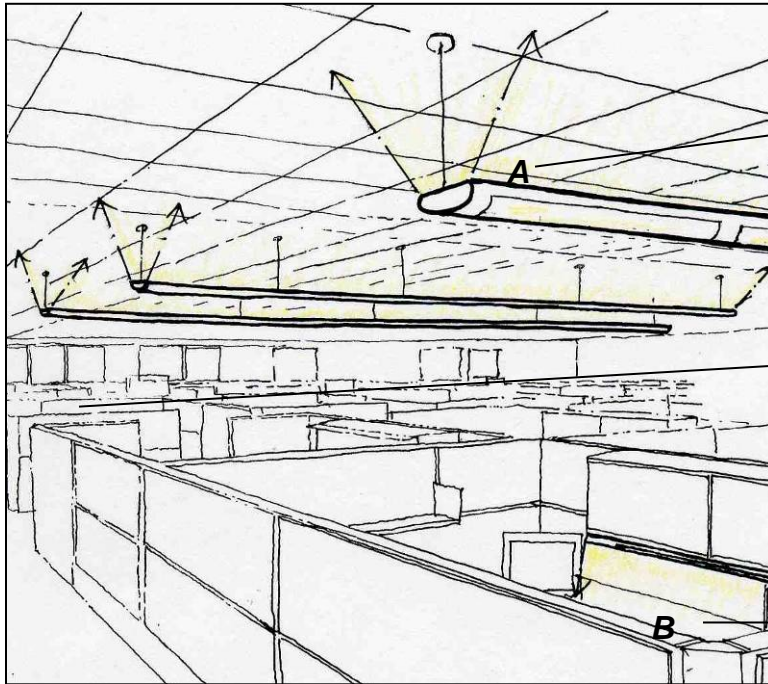

Direct/indirect luminaires selected and located to prevent direct and reflected glare.

Introduce daylight from north and south facades and control glare. Integrate daylight with electric lighting system where appropriate.

Undercabinet or desk mounted task lighting increase illuminance on desks.

EQUIPMENT REQUIREMENTS:

	LUMINAIRE	LIGHT SOURCE	CONTROLS per ASHRAE (refer to General Building Requirements for clarification)
A	Suspended linear, indirect / direct luminaire, mounted 18" – 36" (457 – 914mm) below ceiling. (There are some luminaires available for ceiling heights of 8' (2438mm).)	LED or fluorescent.	Auto on to no more than 50% design lighting power, combined with manual on switching, when occupant activity is sensed. General lighting in daylighted areas separately controlled through multilevel photocontrol (step dimming or continuous dimming) to reduce light output when daylight is available, with at least one control step between 50% and 70% of design lighting power and one control step that is no greater than 35% (including off) of design lighting power. Provide manual control device to independently control general lighting with at least one control step between 30% and 70% design lighting power in addition to all off. Automatic off within 15 minutes of no occupant activity. Each control device must control a maximum of 2500sft area for a space 10000sft or less.
B	Under cabinet task lighting designed for minimal veiling reflections.	LED or fluorescent.	Control device integral to luminaire or controlled by wall mounted control device provided it is located so occupant can see controlled lighting. Manual on or auto on (to no more than 50% power) combined with manual on switching, when occupant enters space. Automatic off within 5 minutes after occupant leaves space.

PERFORMANCE REQUIREMENTS:

Target Criteria	Daytime	Nighttime
<i>Horizontal Illuminance (Average ±10%)</i>	<i>30 fc (300 lux) at 2'-6" (762mm) AFF</i>	
<i>Vertical Illuminance (Average ±10%)</i>	<i>15 fc (150 lux) at 3'-6" (1067mm) AFF</i>	
<i>Horizontal Illuminance Uniformity</i>	<i>2:1 average to minimum</i>	

CRITICAL DESIGN ISSUES:

- Means of egress must comply with NFPA 101 for aisles and passageways leading to an exit.

3-4.5 Open Offices (Alternate Scheme).

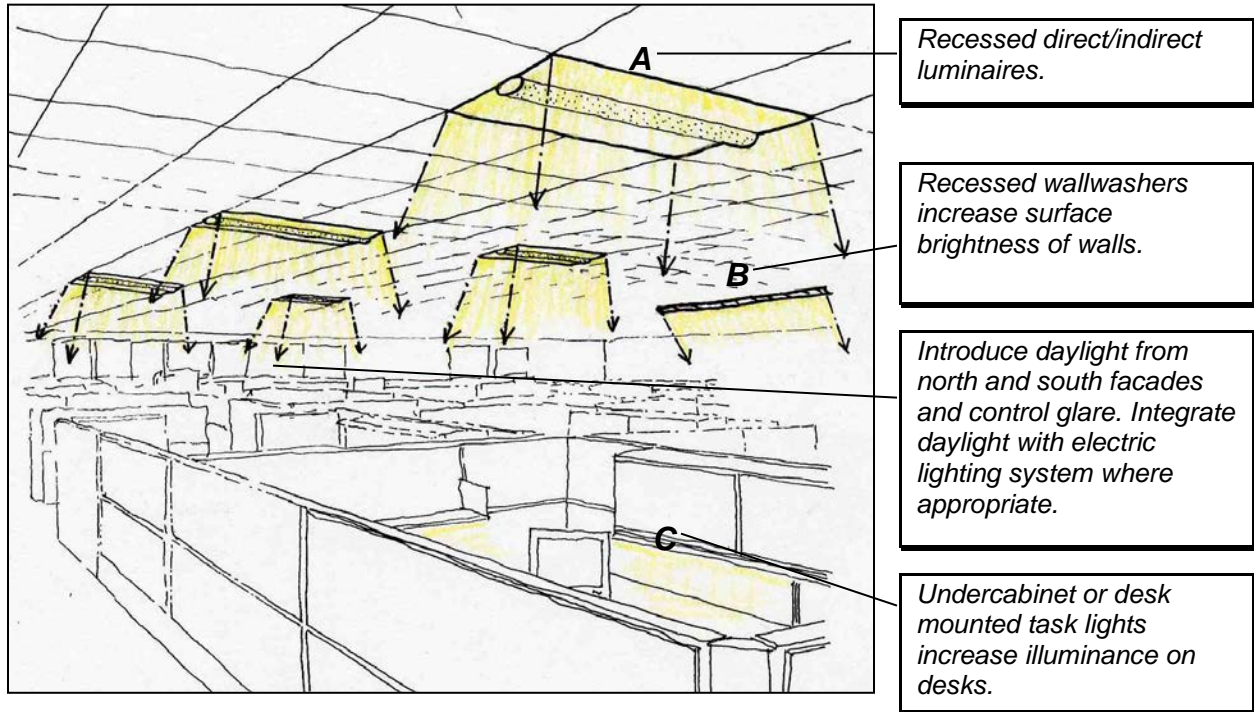

Recessed direct/indirect luminaires.

Recessed wallwashers increase surface brightness of walls.

Introduce daylight from north and south facades and control glare. Integrate daylight with electric lighting system where appropriate.

Undercabinet or desk mounted task lights increase illuminance on desks.

EQUIPMENT REQUIREMENTS:

	LUMINAIRE	LIGHT SOURCE	CONTROLS per ASHRAE (refer to General Building Requirements for clarification)
A	<i>Recessed linear, direct/indirect luminaire.</i>	<i>LED or fluorescent.</i>	<i>Auto on to no more than 50% design lighting power, combined with manual on switching, when occupant activity is sensed. General lighting in daylighted areas separately controlled through multilevel photocontrol (step dimming or continuous dimming) to reduce light output when daylight is available, with at least one control step between 50% and 70% of design lighting power and one control step that is no greater than 35% (including off) of design lighting power. Provide manual control device to independently control general lighting with at least one control step between 30% and 70% of design lighting power in addition to all off. Automatic off within 15 minutes of no occupant activity. Each control device must control a maximum of 2500sft area for a space 10000sft or less.</i>
B	<i>Recessed wallwashers.</i>	<i>LED or fluorescent.</i>	<i>Auto on to no more than 50% design lighting power, combined with manual on switching, when occupant activity is sensed. Automatic off within 15 minutes of no occupant</i>

			<i>activity. Each control device must control a maximum of 2500sft area for a space 10000sft or less.</i>
C	<i>Under cabinet task lighting.</i>	<i>LED or fluorescent.</i>	<i>Control device integral to luminaire or controlled by wall mounted control device provided it is located so occupant can see controlled lighting. Manual on or auto on (to no more than 50% power) combined with manual on switching, when occupant enters space. Automatic off within 5 minutes after occupant leaves space.</i>

PERFORMANCE REQUIREMENTS:

Target Criteria	Daytime	Nighttime
<i>Horizontal Illuminance (Average ±10%)</i>	<i>30 fc (300 lux) at 2'-6" (762mm) AFF</i>	
<i>Vertical Illuminance (Average ±10%)</i>	<i>15 fc (150 lux) at 3'-6" (1067mm) AFF</i>	
<i>Horizontal Illuminance Uniformity</i>	<i>2:1 average to minimum</i>	

CRITICAL DESIGN ISSUES:

- Minimize glare with solutions such as diffuse lens or shielded louvers.
- Light room surfaces to balance out luminance ratios.
- Coordinate with architect for shading devices that eliminate direct sunlight.
- In retrofit applications, ensure that heat management of luminaires is adequate and does not compromise rated life of luminaire.
- Means of egress must comply with NFPA 101 for aisles and passageways leading to an exit.

3-4.6 Waiting Areas.

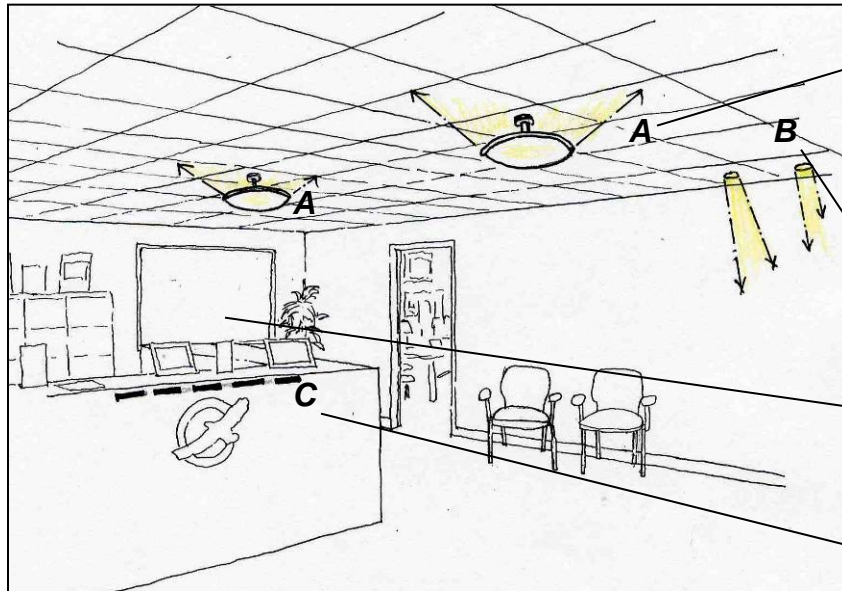

Suspended or surface mounted luminaires provide surface brightness and vertical illuminance.

Recessed wallwashers or accent lights increase wall brightness and highlight features.

Introduce and control daylight. Integrate with electric lighting system to reduce energy use.

Task lighting increases the illuminance on a task, allowing the ambient light levels to be lower.

EQUIPMENT REQUIREMENTS:

	LUMINAIRE	LIGHT SOURCE	CONTROLS per ASHRAE (refer to General Building Requirements for clarification)
A	<i>Suspended or surface mounted decorative luminaire.</i>	<i>LED or fluorescent.</i>	<i>Manual on, or auto on (to no more than 50% design lighting power) combined with manual on switching, when occupant enters room. General lighting in daylighted areas separately controlled through multilevel photocontrol (step dimming or continuous dimming) to reduce light output when daylight is available, with at least one control step between 50% and 70% of design lighting power and one control step that is no greater than 35% (including off) of design lighting power. Provide manual control device to independently control general lighting with at least one control step between 30% and 70% of design lighting power in addition to all off. Automatic off within 15 minutes of closing. The occupant must be able to override any time-of-day scheduled shutoff control for no more than two hours.</i>
A ALT	<i>Recessed direct / indirect linear luminaire.</i>	<i>LED or fluorescent.</i>	
B	<i>Recessed downlight/ wallwasher.</i>	<i>LED or fluorescent.</i>	<i>Manual on, or auto on (to no more than 50% design lighting power) combined with manual on switching, when occupant enters room. Automatic off within 15 minutes of closing. The occupant must be able to override any time-of-day scheduled shutoff control for no more than two</i>
B ALT	<i>Recessed linear downlight / wallwashers.</i>	<i>LED or fluorescent.</i>	

			<i>hours.</i>
C	<i>Task lighting.</i>	<i>LED or fluorescent.</i>	<i>Control device integral to luminaire or controlled by wall mounted control device provided it is located so occupant can see controlled lighting. Manual on, or auto on (to no more than 50% power) combined with manual on switching, when occupant enters space. Automatic off within 5 minutes after occupant leaves space.</i>

PERFORMANCE REQUIREMENTS:

Target Criteria	Daytime	Nighttime
<i>Horizontal Illuminance (Average ±10%)</i>	<i>10 fc (100 lux) at 2'-6" (762mm) AFF</i>	<i>5 fc (50 lux) at 2'-6" (762mm) AFF</i>
<i>Vertical Illuminance (Average ±10%)</i>	<i>5 fc (50 lux) at 5'-0" (1524mm) AFF</i>	<i>2 fc (20 lux) at 5'-0" (1524mm) AFF</i>
<i>Horizontal Illuminance Uniformity</i>	<i>4:1 average to minimum</i>	

CRITICAL DESIGN ISSUES:

- Select aesthetically pleasing luminaires.
- Light room surfaces to balance out luminance ratios.

3-4.7 Conference Rooms.

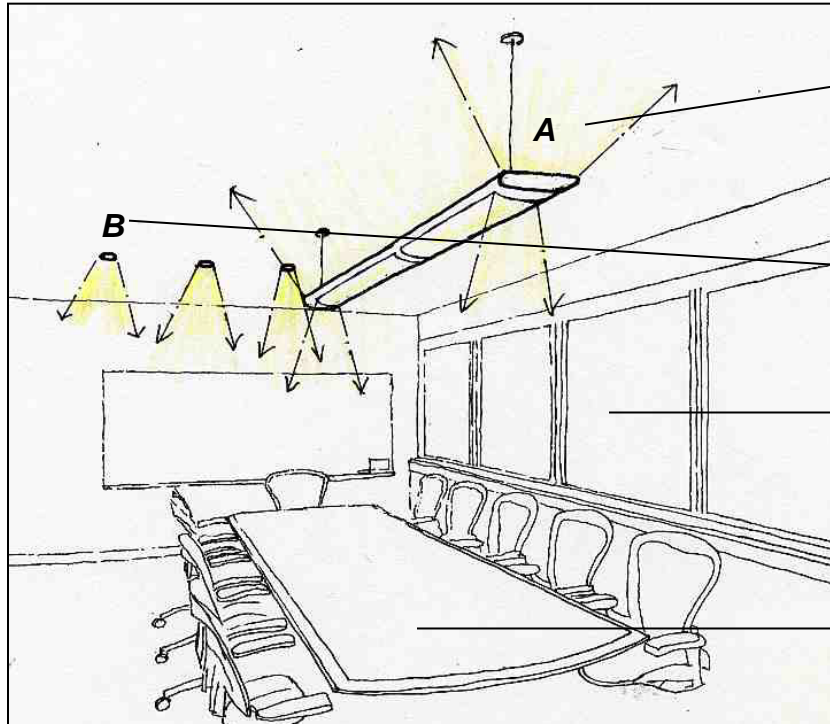

Direct/ indirect luminaires provide surface brightness and indirect ambient light.

Wallwashers light walls and / or whiteboards.

Introduce daylight from north and south facades and control glare. Provide horizontal blinds. Integrate with electric lighting system.

Luminaire over table provides uniform task illuminance.

EQUIPMENT REQUIREMENTS:

	LUMINAIRE	LIGHT SOURCE	CONTROLS per ASHRAE (refer to General Building Requirements for clarification)
A	<i>Suspended linear, indirect / direct luminaire, mounted 18" – 36" (457 – 914mm) below ceiling. (There are some luminaires available for ceiling heights of 8' (2438mm).)</i>	<i>LED or fluorescent.</i>	<i>Manual on. General lighting in daylighted areas separately controlled through multilevel photocontrol (step dimming or continuous dimming) to reduce light output when daylight is available, with at least one control step between 50% and 70% of design lighting power and one control step that is no greater than 35% (including off) of design lighting power. Provide manual control device to independently control general lighting with at least one control step between 30% and 70% of design lighting power in addition to all off. Automatic off within 15 minutes of no occupant activity.</i>
B	<i>Recessed downlight / wallwashers.</i>	<i>LED or fluorescent.</i>	<i>Manual on. Provide manual control device to independently control general lighting with at least one control step between 30% and 70% of design lighting power in addition to all off. Automatic off within 15 minutes of no occupant activity.</i>
B ALT	<i>Recessed linear downlight / wallwashers.</i>	<i>LED or fluorescent.</i>	

PERFORMANCE REQUIREMENTS:

Target Criteria	Daytime	Nighttime
<i>Horizontal Illuminance (Average $\pm 10\%$)</i>	<i>30 fc (300 lux) at 2'-6" (762mm) AFF</i>	
<i>Vertical Illuminance (Average $\pm 10\%$)</i>	<i>7.5 fc (75 lux) at 4'-0" (1524mm) AFF</i>	
<i>Horizontal Illuminance Uniformity</i>	<i>1.5:1 average to minimum</i>	

CRITICAL DESIGN ISSUES:

- Minimize glare with solutions such as diffuse lens or shielded louvers.
- Select aesthetically pleasing luminaires.
- Light room surfaces to balance out luminance ratios.
- Coordinate with architect for shading devices that eliminate direct sunlight.
- Refer to IES DG-17 *Fundamentals of Lighting for Videoconferencing*.

3-4.8 Boardrooms / Large Conference Rooms.

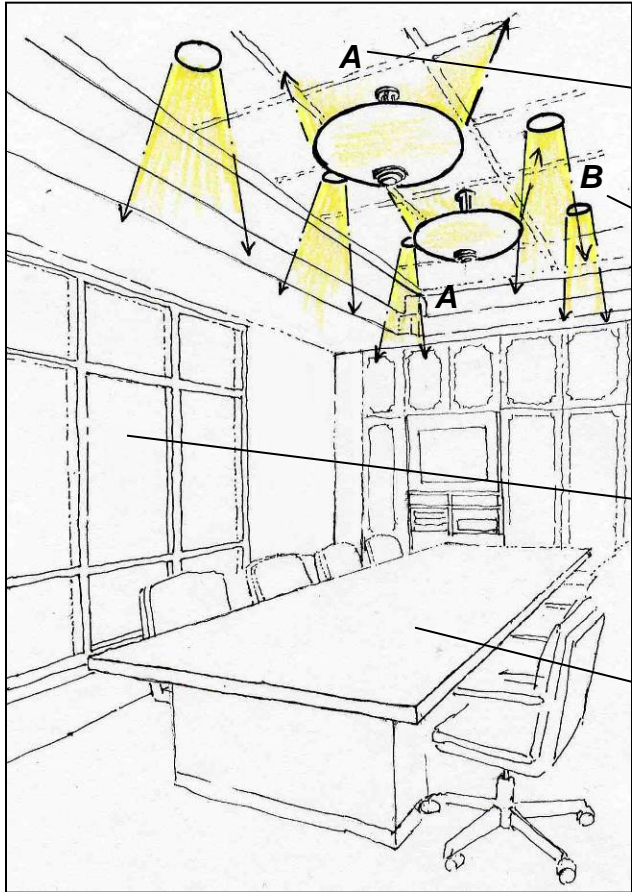

Decorative pendants uplight ceiling and provide indirect ambient light.

Downlight / wallwashers increases room surface brightness.

Introduce daylight from north and south facades and control glare. Provide horizontal blinds. Integrate with electric lighting system.

Luminaires over the table provide uniform task illuminance.

EQUIPMENT REQUIREMENTS:

	LUMINAIRE	LIGHT SOURCE	CONTROLS per ASHRAE (refer to General Building Requirements for clarification)
A	<i>Suspended decorative, indirect / direct luminaire.</i>	<i>LED or fluorescent.</i>	<p><i>Manual on.</i></p> <p><i>General lighting in daylighted areas separately controlled through multilevel photocontrol (step dimming or continuous dimming) to reduce light output when daylight is available, with at least one control step between 50% and 70% of design lighting power and one control step that is no greater than 35% (including off) of design lighting power.</i></p> <p><i>Provide manual control device to independently control general lighting with at least one control step between 30% and 70% of design lighting power in addition to all off.</i></p> <p><i>Automatic off within 15 minutes of no occupant activity.</i></p>
B	<i>Recessed downlight / wallwashers.</i>	<i>LED or fluorescent.</i>	<p><i>Manual on.</i></p> <p><i>Provide manual control device to independently control general lighting with at least one control step between 30% and 70% of design lighting power in addition to all off.</i></p> <p><i>Automatic off within 15 minutes of no occupant activity.</i></p>
B ALT	<i>Recessed linear downlight / wallwashers.</i>	<i>LED or fluorescent.</i>	

PERFORMANCE REQUIREMENTS:

Target Criteria	Daytime	Nighttime
<i>Horizontal Illuminance (Average ±10%)</i>	<i>30 fc (300 lux) at 2'-6" (762mm) AFF</i>	
<i>Vertical Illuminance (Average ±10%)</i>	<i>15 fc (150 lux) at 3'-6" (1067mm) AFF</i>	
<i>Horizontal Illuminance Uniformity</i>	<i>2.5:1 average to minimum</i>	

CRITICAL DESIGN ISSUES:

- Minimize glare with solutions such as diffuse lens or shielded louvers. Select aesthetically pleasing luminaires.
- Light room surfaces to balance out luminance ratios.
- Coordinate with architect for shading devices that eliminate direct sunlight.
- Refer to IES DG-17 *Fundamentals of Lighting for Videoconferencing*.

3-4.9 Ceremonial Areas.

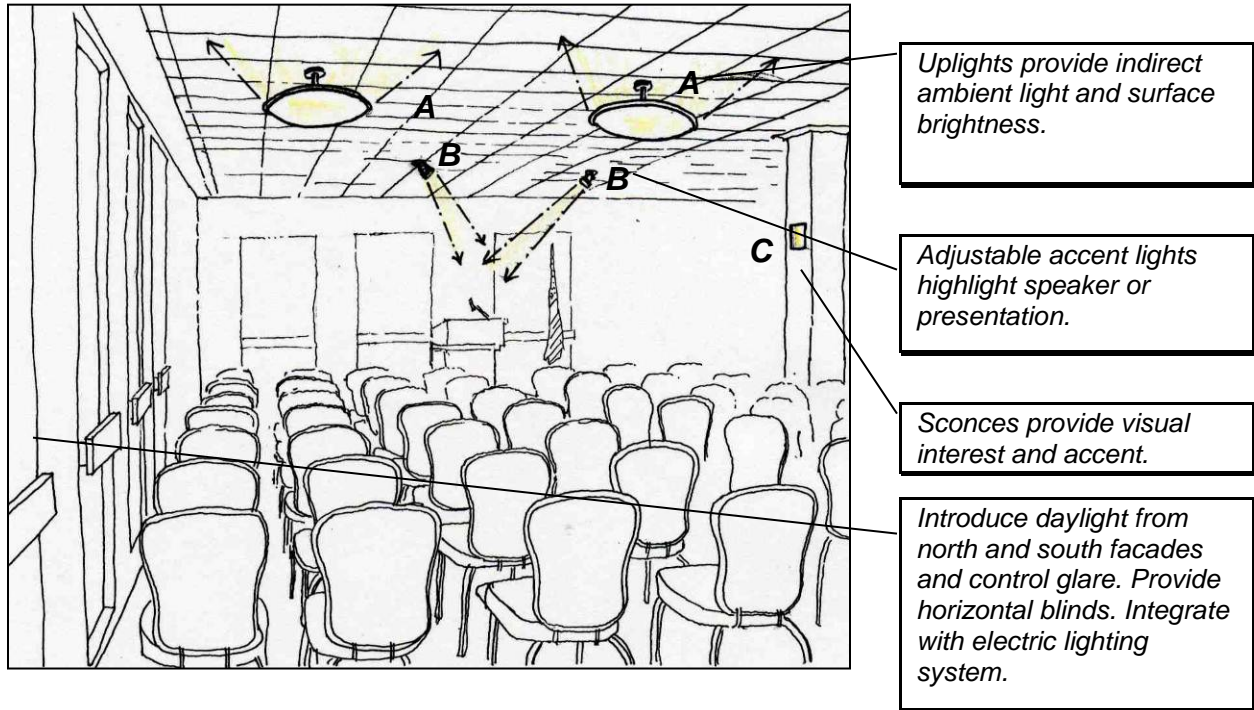

EQUIPMENT REQUIREMENTS:

	LUMINAIRE	LIGHT SOURCE	CONTROLS per ASHRAE (refer to General Building Requirements for clarification)
A	<i>Suspended uplight.</i>	<i>LED or fluorescent light source.</i>	<i>Manual on. Provide continuous dimming as separate zone or part of scene controller. General lighting in daylit areas separately controlled through multilevel photocontrol (step dimming or continuous dimming) to reduce light output when daylight is available, with at least one control step between 50% and 70% of design lighting power and one control step that is no greater than 35% (including off) of design lighting power. Automatic off within 15 minutes of no occupant activity.</i>
B	<i>Surface or recessed adjustable accent light.</i>	<i>LED</i>	<i>Manual on. Provide continuous dimming as separate zone or part of scene controller. Automatic off within 15 minutes of no occupant activity.</i>
C	<i>Wall mounted sconce.</i>	<i>LED or fluorescent.</i>	<i>Manual on. Provide continuous dimming as separate zone or part of scene controller. Automatic off within 15 minutes of no occupant activity.</i>

PERFORMANCE REQUIREMENTS:

Target Criteria	Daytime	Nighttime
<i>Horizontal Illuminance (Average $\pm 10\%$)</i>	<i>10 fc (100 lux) at 2'-6" (762mm) AFF</i>	
<i>Vertical Illuminance (Average $\pm 10\%$)</i>	<i>5 fc (50 lux) at 3'-6" (1067mm) AFF</i>	
<i>Horizontal Illuminance Uniformity</i>	<i>3:1 average to minimum</i>	

CRITICAL DESIGN ISSUES:

- Keep ambient lighting low. Provide accent lighting on speaker.
- Light rooms surfaces to balance out luminance ratios.
- Coordinate with architect for shading devices that eliminate direct sunlight.

3-4.10 Office Support Areas.

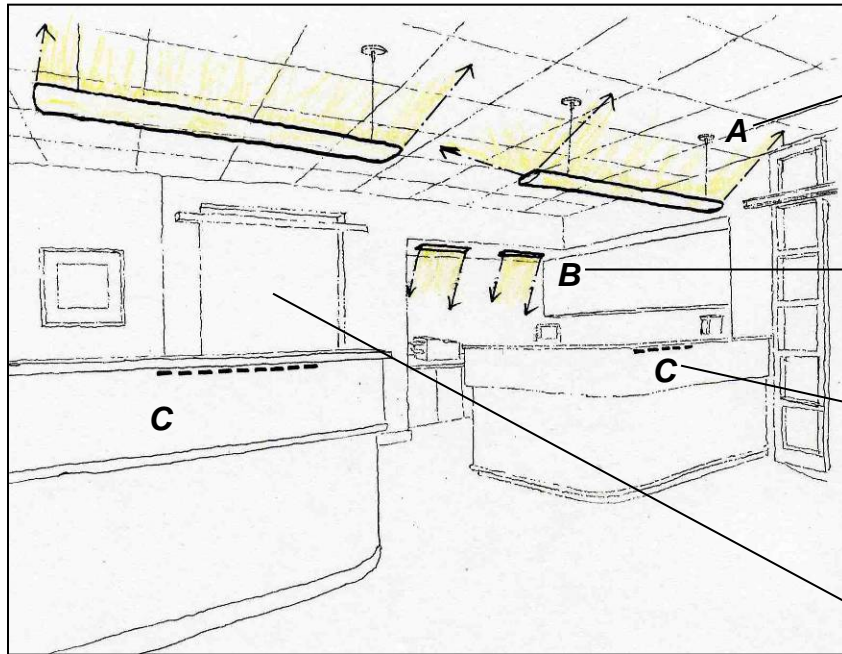

Direct/indirect luminaires selected and located to prevent direct and reflected glare.

Recessed wallwashers increase wall brightness.

Task lighting increases the illuminance on a task, allowing the ambient light levels to be lower.

Introduce and control daylight on north and south facades. Integrate with electric light controls to reduce energy use.

EQUIPMENT REQUIREMENTS:

	LUMINAIRE	LIGHT SOURCE	CONTROLS per ASHRAE (refer to General Building Requirements for clarification)
A	<i>Suspended linear, indirect / direct luminaire, mounted 18" – 36" (457 – 914mm) below ceiling. (There are some luminaires available for ceiling heights of 8' (2438mm).)</i>	<i>LED or fluorescent.</i>	<i>Manual on. General lighting in daylighted areas separately controlled through multilevel photocontrol (step dimming or continuous dimming) to reduce light output when daylight is available, with at least one control step between 50% and 70% of design lighting power and one control step that is no greater than 35% (including off) of design lighting power. Provide manual control device to independently control general lighting with at least one control step between 30% and 70% of design lighting power in addition to all off. Automatic off within 30 minutes of no occupant activity.</i>
B	<i>Recessed linear wall washer.</i>	<i>LED or fluorescent.</i>	<i>Manual on. Automatic off within 30 minutes of no occupant activity.</i>
C	<i>Task lightings.</i>	<i>LED or fluorescent light source.</i>	<i>Control device integral to luminaire or controlled by wall mounted control device provided it is located so occupant can see controlled lighting. Manual on, or auto on (to no more than 50% power) combined with manual on switching, when occupant enters space. Automatic off within 5 minutes after occupant leaves space.</i>

PERFORMANCE REQUIREMENTS:

Target Criteria	Daytime	Nighttime
<i>Horizontal Illuminance (Average ±10%)</i>	<i>40 fc (400 lux) at 2'-6" (762mm) AFF</i>	
<i>Vertical Illuminance (Average ±10%)</i>	<i>15 fc (150 lux) at 3'-6" (1067mm) AFF</i>	
<i>Horizontal Illuminance Uniformity</i>	<i>2:1 average to minimum</i>	

CRITICAL DESIGN ISSUES:

- Minimize glare with solutions such as diffuse lens or shielded louvers.
- Light room surfaces to balance out luminance ratios.
- Coordinate with architect for shading devices that eliminate direct sunlight.

3-5 EDUCATIONAL SPACES.

3-5.1 Classroom/Training Room.

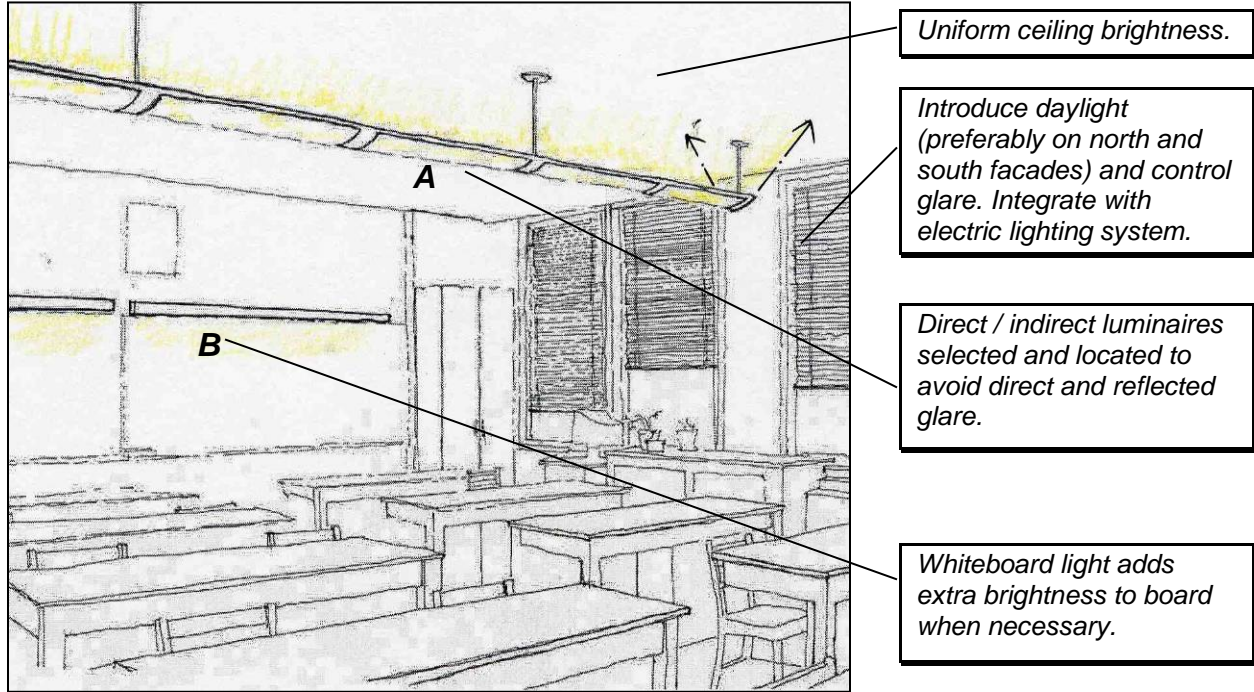

EQUIPMENT REQUIREMENTS:

	LUMINAIRE	LIGHT SOURCE	CONTROLS per ASHRAE (refer to General Building Requirements for clarification)
A	<i>Suspended linear, indirect / direct luminaire, mounted 18" – 36" (457 – 914mm) below ceiling. (There are some luminaires available for ceiling heights of 8' (2438mm).)</i>	<i>LED or fluorescent.</i>	<i>Manual on. General lighting in daylighted areas separately controlled through multilevel photocontrol (step dimming or continuous dimming) to reduce light output when daylight is available, with at least one control step between 50% and 70% of design lighting power and one control step that is no greater than 35% (including off) of design lighting power. Provide manual control device to independently control general lighting with at least one control step between 30% and 70% of design lighting power in addition to all off. Automatic off within 15 minutes of no occupant activity.</i>
B	<i>Linear whiteboard light.</i>	<i>LED or fluorescent.</i>	<i>Manual on. Automatic off within 15 minutes of no occupant activity.</i>

PERFORMANCE REQUIREMENTS:

Target Criteria	Daytime	Nighttime
<i>Horizontal Illuminance (Average $\pm 10\%$)</i>	<i>40 fc (400 lux) at 2'-6" (762mm) AFF</i>	
<i>Vertical Illuminance (Average $\pm 10\%$)</i>	<i>30 fc (300 lux) at 3'-6" (1067mm) AFF</i>	
<i>Horizontal Illuminance Uniformity</i>	<i>2:1 average to minimum</i>	

CRITICAL DESIGN ISSUES:

- Coordinate with architect for shading devices that eliminate direct sunlight.
- Control glare from windows and clerestories.
- Provide luminaires with lenses or louvers to minimize direct glare.
- Provide even illumination (both electric and daylight) to the space.
- Light room surfaces to balance out luminance ratios.

3-5.2 Auditoriums.

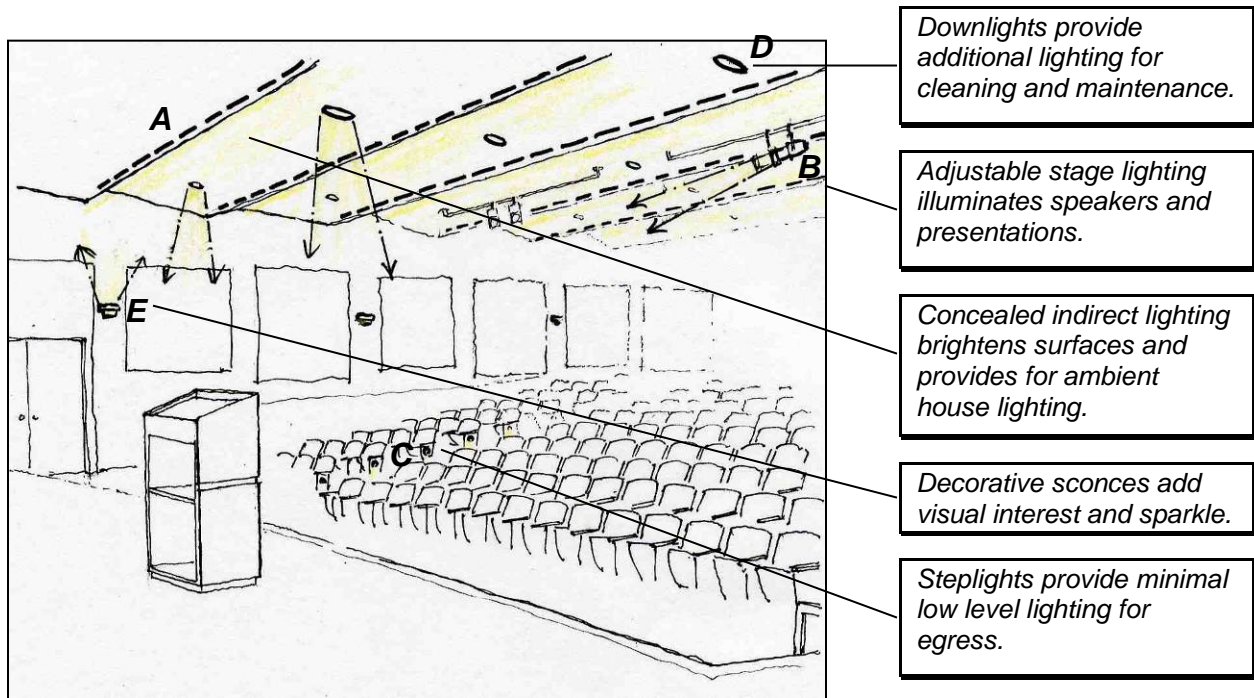

Downlights provide additional lighting for cleaning and maintenance.

Adjustable stage lighting illuminates speakers and presentations.

Concealed indirect lighting brightens surfaces and provides for ambient house lighting.

Decorative sconces add visual interest and sparkle.

Steplights provide minimal low level lighting for egress.

EQUIPMENT REQUIREMENTS:

	LUMINAIRE	LIGHT SOURCE	CONTROLS per ASHRAE (refer to General Building Requirements for clarification)
A	Concealed linear uplight.	LED or fluorescent.	Manual on. Provide continuous dimming as separate zone or part of scene controller. Automatic off within 15 minutes of no occupant activity.
B	Adjustable spotlight.	LED or tungsten halogen PAR38 spot or narrow floodlight.	Manual on. Provide continuous dimming as separate zone or part of scene controller. Automatic off within 15 minutes of no occupant activity.
C	Surface or recessed mounted steplight on edge of stair or in seats.	LED	Manual on. Provide continuous dimming as separate zone or part of scene controller. Automatic off within 15 minutes of no occupant activity.
D	Surface, recessed, or suspended downlight.	LED or fluorescent.	Manual on. Provide continuous dimming as separate zone or part of scene controller. Automatic off within 15 minutes of no occupant activity.
E	Wall mounted sconce.	LED or fluorescent.	Manual on. Provide continuous dimming as separate zone or part of scene controller. Automatic off within 15 minutes of no occupant activity.

PERFORMANCE REQUIREMENTS:

Target Criteria	Daytime	Nighttime
<i>Horizontal Illuminance (Average $\pm 10\%$)</i>	<i>5 fc (50 lux) at 2'-0" (910mm) AFF</i>	
<i>Vertical Illuminance (Average $\pm 10\%$)</i>	<i>15 fc (150 lux) at 4'-0" (1219mm) AFF</i>	
<i>Horizontal Illuminance Uniformity</i>	<i>2:1 average to minimum</i>	

CRITICAL DESIGN ISSUES:

- Provide luminaires with lenses or louvers to minimize direct glare.
- Keep ambient lighting low.
- Provide accent lighting on speaker.
- Avoid harsh shadows by lighting the speaker from the sides.
- Provide egress lighting along the edge of the aisles.
- Light room surfaces to balance out luminance ratios.

3-6 HEALTHCARE SPACES.

3-6.1 Waiting Rooms.

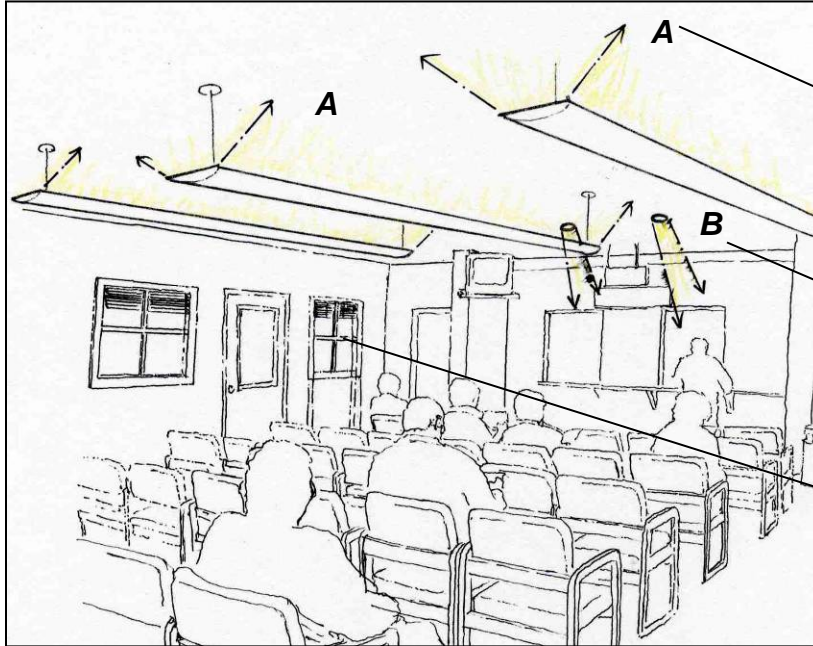

Uplights provide indirect ambient light.

Recessed wallwashers/ downlights increase wall brightness and highlight features

Introduce and control daylight. Provide controls to turn off lighting that is not required.

EQUIPMENT REQUIREMENTS:

	LUMINAIRE	LIGHT SOURCE	CONTROLS per ASHRAE (refer to General Building Requirements for clarification)
A	<i>Suspended linear indirect / direct luminaire.</i>	<i>LED or fluorescent light source.</i>	<i>Manual on, or auto on to 50% design lighting power, combined with manual on switching, when occupant enters room.</i>
A ALT	<i>Suspended decorative uplight.</i>	<i>LED or fluorescent.</i>	<i>General lighting in daylighted areas separately controlled through multilevel photocontrol (step dimming or continuous dimming) to reduce light output when daylight is available, with at least one control step between 50% and 70% of design lighting power and one control step that is no greater than 35% (including off) of design lighting power. Provide manual control device to independently control general lighting with at least one control step between 30% and 70% of design lighting power in addition to all off. Automatic off within 15 minutes of closing. The occupant must be able to override any time-of-day scheduled shutoff control for no more than two hours.</i>
B	<i>Recessed downlight / wallwashers.</i>	<i>LED or fluorescent.</i>	<i>Manual on, or auto on to 50% design lighting power, combined with manual on switching, when occupant enters room.</i>
B ALT	<i>Recessed linear downlight / wallwashers.</i>	<i>LED or fluorescent light source.</i>	<i>Automatic off within 15 minutes of closing. The occupant must be able to override any time-of-day scheduled shutoff control for no more than two hours.</i>

PERFORMANCE REQUIREMENTS:

Target Criteria	Daytime	Nighttime
<i>Horizontal Illuminance (Average ±10%)</i>	<i>20 fc (200 lux) at floor</i>	<i>10 fc (100 lux) at floor</i>
<i>Vertical Illuminance (Average ±10%)</i>	<i>7.5 fc (75 lux) at 5'-0" (1524mm) AFF</i>	<i>3 fc (30 lux) at 5'-0" (1524mm) AFF</i>
<i>Horizontal Illuminance Uniformity</i>	<i>4:1 average to minimum</i>	

CRITICAL DESIGN ISSUES:

- Select aesthetically pleasing luminaires.
- Light room surfaces to balance out luminance ratios.

3-6.2 Pharmacy.



Recessed direct/ indirect luminaire minimizes direct glare.

Under shelf task lights provide higher light levels on counter.

EQUIPMENT REQUIREMENTS:

	LUMINAIRE	LIGHT SOURCE	CONTROLS per ASHRAE (refer to General Building Requirements for clarification)
A	<i>Recessed indirect / direct linear luminaire.</i>	<i>LED or Ifluorescent.</i>	<i>Manual on. Provide manual control device to independently control general lighting with at least one control step between 30% and 70% of design lighting power in addition to all off. Automatic off within 15 minutes of no occupant activity.</i>
A ALT	<i>Recessed parabolic linear luminaire.</i>	<i>LED or fluorescent.</i>	
B	<i>Under shelf task light.</i>	<i>LED or fluorescent, light sources.</i>	<i>Control device integral to luminaire or controlled by wall mounted control device provided it is located so occupant can see controlled lighting. Manual on. Automatic off within 15 minutes of no occupant activity.</i>

PERFORMANCE REQUIREMENTS:

Target Criteria	Daytime	Nighttime
<i>Horizontal Illuminance (Average $\pm 10\%$)</i>	<i>50 fc (500 lux) at 3'-0" (914mm) AFF</i>	
<i>Vertical Illuminance (Average $\pm 10\%$)</i>	<i>20 fc (200 lux) at 4'-0" (1219mm) AFF</i>	
<i>Horizontal Illuminance Uniformity</i>	<i>3:1 average to minimum</i>	

CRITICAL DESIGN ISSUES:

- Provide luminaires with lenses or louvers to minimize glare.
- Provide uniform illuminance on the task plane.
- Light room surfaces to balance out luminance ratios.

3-7 FOOD SERVICE SPACES.

3-7.1 Kitchens.

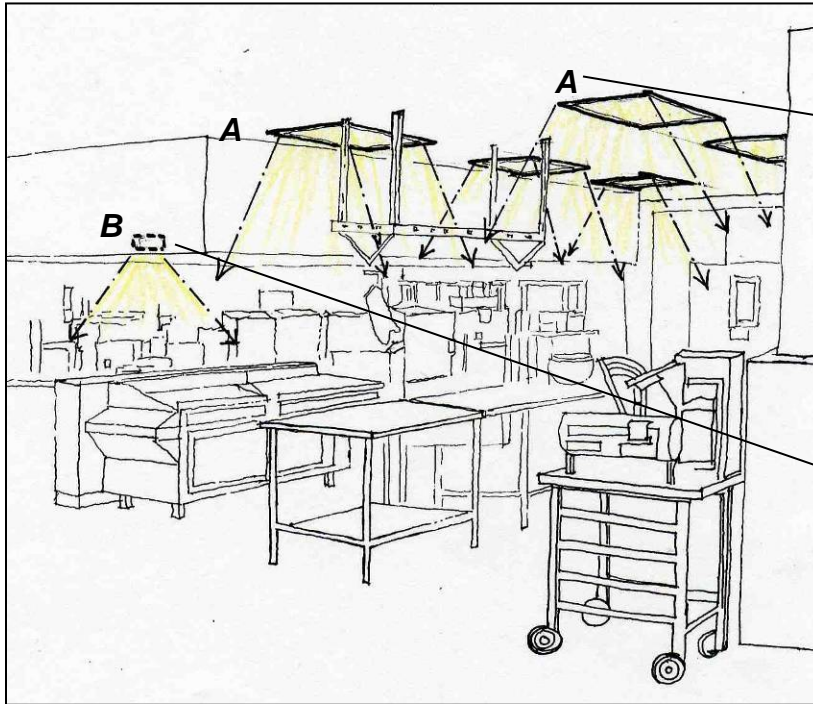

Recessed lensed luminaires provide high illuminance levels on the work plane.

LED or compact fluorescent luminaires located inside hood provide additional lighting over grill.

EQUIPMENT REQUIREMENTS:

	LUMINAIRE	LIGHT SOURCE	CONTROLS per ASHRAE (refer to General Building Requirements for clarification)
A	<i>Recessed linear downlight with gasketed lens.</i>	<i>LED or fluorescent.</i>	<i>Manual on. Provide manual control device to independently control general lighting with at least one control step between 30% and 70% of design lighting power in addition to all off. Automatic off within 15 minutes of no occupant activity.</i>
B	<i>Surface mounted task light under counter or under hood. (Often procured as part of the hood.)</i>	<i>LED or fluorescent.</i>	<i>Control device integral to luminaire or controlled by wall mounted control device provided it is located so occupant can see controlled lighting. Manual on. Automatic off within 15 minutes of no occupant activity.</i>

PERFORMANCE REQUIREMENTS:

Target Criteria	Daytime	Nighttime
<i>Horizontal Illuminance (Average $\pm 10\%$)</i>	<i>50 fc (500 lux) at food preparation surface</i>	
<i>Vertical Illuminance (Average $\pm 10\%$)</i>	<i>20 fc (200 lux) at food preparation surface</i>	
<i>Horizontal Illuminance Uniformity</i>	<i>1.5:1 average to minimum</i>	

CRITICAL DESIGN ISSUES:

- Locate lighting equipment to minimize shadows.

3-7.2 Cafeterias.

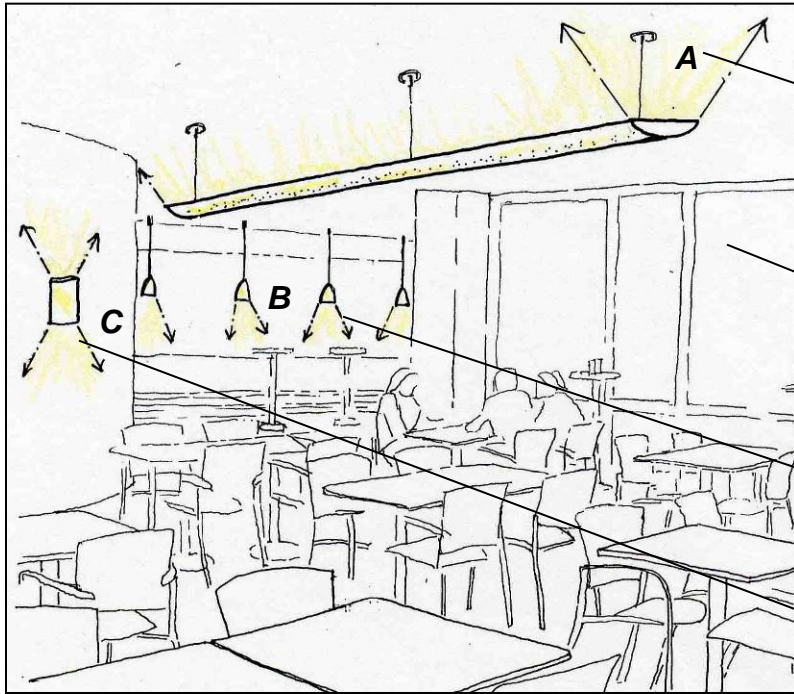

Indirect / direct luminaires light the ceiling while still providing a small direct component.

Daylight should be introduced into the space, controlled, and integrated with the electric lighting.

Low wattage accent lighting helps to highlight points of interest.

Wall sconces provide surface brightness and visual interest.

EQUIPMENT REQUIREMENTS:

	LUMINAIRE	LIGHT SOURCE	CONTROLS per ASHRAE (refer to General Building Requirements for clarification)
A	Suspended linear indirect / direct luminaire.	LED or fluorescent.	Manual on, or auto on (to no more than 50% design lighting power) combined with manual on switching, when occupant enters room. General lighting in daylighted areas separately controlled through multilevel photocontrol (step dimming or continuous dimming) to reduce light output when daylight is available, with at least one control step between 50% and 70% of design lighting power and one control step that is no greater than 35% (including off) of design lighting power. Provide manual control device to independently control general lighting with at least one control step between 30% and 70% of design lighting power in addition to all off. Automatic off within 30 minutes of no occupant activity.
B	Suspended low voltage decorative accent light.	LED.	Manual on, or auto on (to no more than 50% design lighting power) combined with manual on switching, when occupant enters room. Automatic off within 30 minutes of no occupant activity.

C	<i>Wall mounted sconce.</i>	<i>LED or fluorescent.</i>	<p><i>Manual on, or auto on (to no more than 50% design lighting power) combined with manual on switching, when occupant enters room.</i></p> <p><i>Automatic off within 30 minutes of no occupant activity.</i></p>
----------	-----------------------------	----------------------------	--

PERFORMANCE REQUIREMENTS:

Target Criteria	Ambient	Food Display
<i>Horizontal Illuminance (Average ±10%)</i>	<i>15 fc (150 lux) at 2'-6" (762mm) AFF</i>	<i>50 fc (500 lux) at food preparation surface</i>
<i>Vertical Illuminance (Average ±10%)</i>	<i>5 fc (50 lux) at 4'-0" (1219mm) AFF</i>	<i>20 fc (200 lux) at food preparation surface</i>
<i>Horizontal Illuminance Uniformity</i>	<i>3:1 average to minimum</i>	

CRITICAL DESIGN ISSUES:

- Use accent lighting to provide wayfinding.
- Light room surfaces to balance out luminance ratios.
- Coordinate with architect for shading devices that eliminate direct sunlight.

3-7.3 Enlisted Dining Rooms.



Wall mounted uplights provide indirect lighting and uniform ceiling brightness.

Suspended luminaire over tables creates decorative accent lighting.

Introduce daylight and control glare. Integrate with electric lighting system.

EQUIPMENT REQUIREMENTS:

	LUMINAIRE	LIGHT SOURCE	CONTROLS per ASHRAE (refer to General Building Requirements for clarification)
A	Wall mounted indirect luminaire.	LED or fluorescent.	Manual on. General lighting in daylighted areas separately controlled through multilevel photocontrol (step dimming or continuous dimming) to reduce light output when daylight is available, with at least one control step between 50% and 70% of design lighting power and one control step that is no greater than 35% (including off) of design lighting power. Provide manual control device to independently control general lighting with at least one control step between 30% and 70% of design lighting power in addition to all off. Automatic off within 30 minutes of no occupant activity.
B	Suspended luminaire.	LED or fluorescent.	Manual on. Automatic off within 30 minutes of no occupant activity.

PERFORMANCE REQUIREMENTS:

Target Criteria	Ambient	Food Display
<i>Horizontal Illuminance (Average ±10%)</i>	<i>15 fc (150 lux) at 2'-6" (762mm) AFF</i>	<i>50 fc (500 lux) at food preparation surface</i>
<i>Vertical Illuminance (Average ±10%)</i>	<i>5 fc (50 lux) at 4'-0" (1219mm) AFF</i>	<i>20 fc (200 lux) at food preparation surface</i>
<i>Horizontal Illuminance Uniformity</i>	<i>3:1 average to minimum</i>	

CRITICAL DESIGN ISSUES:

- Use accent lighting to provide wayfinding.
- Provide low wattage luminaires to avoid excessive brightness.
- Light room surfaces to balance out luminance ratios.
- Coordinate with architect for shading devices that eliminate direct sunlight.

3-7.4 Officer Dining Rooms.

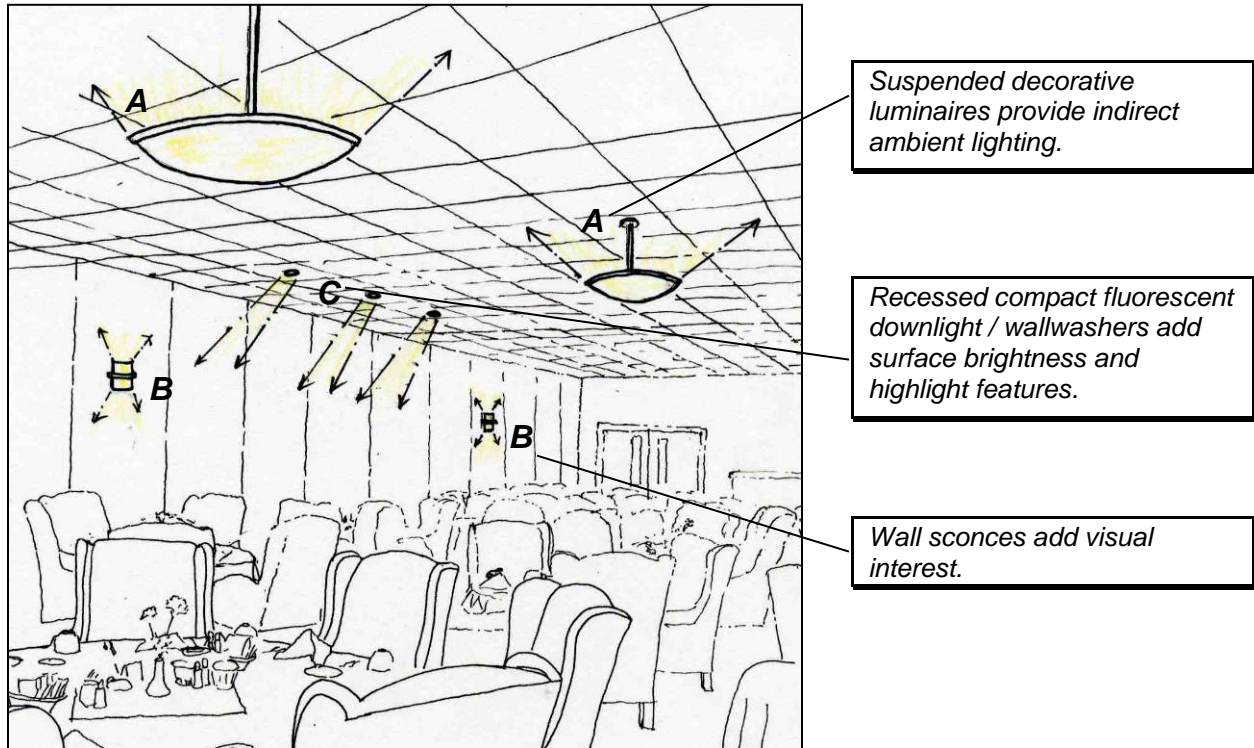

Suspended decorative luminaires provide indirect ambient lighting.

Recessed compact fluorescent downlight / wallwashers add surface brightness and highlight features.

Wall sconces add visual interest.

EQUIPMENT REQUIREMENTS:

	LUMINAIRE	LIGHT SOURCE	CONTROLS per ASHRAE (refer to General Building Requirements for clarification)
A	<i>Suspended decorative uplight.</i>	<i>LED or fluorescent.</i>	<i>Manual on. Provide continuous dimming as separate zone or part of scene controller. Automatic off within 15 minutes of no occupant activity.</i>
B	<i>Wall mounted sconce.</i>	<i>LED or fluorescent.</i>	<i>Manual on. Provide continuous dimming as separate zone or part of scene controller. Automatic off within 15 minutes of no occupant activity.</i>
C	<i>Recessed downlight wallwasher.</i>	<i>LED or fluorescent.</i>	<i>Manual on. Provide continuous dimming as separate zone or part of scene controller.</i>
C ALT	<i>Recessed linear downlight / wallwashers.</i>	<i>LED or fluorescent.</i>	<i>Automatic off within 15 minutes of no occupant activity.</i>

PERFORMANCE REQUIREMENTS:

Target Criteria	Ambient	Food Display
<i>Horizontal Illuminance (Average ±10%)</i>	<i>10 fc (100 lux) at table plane</i>	<i>50 fc (500 lux) at food preparation surface</i>
<i>Vertical Illuminance (Average ±10%)</i>	<i>5 fc (50 lux) at 4'-0" (1219mm) AFF</i>	<i>20 fc (200 lux) at food preparation surface</i>
<i>Horizontal Illuminance Uniformity</i>	<i>3:1 average to minimum</i>	

CRITICAL DESIGN ISSUES:

- Select aesthetically pleasing luminaires.
- Provide low wattage luminaires to avoid excessive brightness.
- Light room surfaces to balance out luminance ratios.

3-8 RECREATIONAL SPACES.

3-8.1 Indoor Swimming Pools.

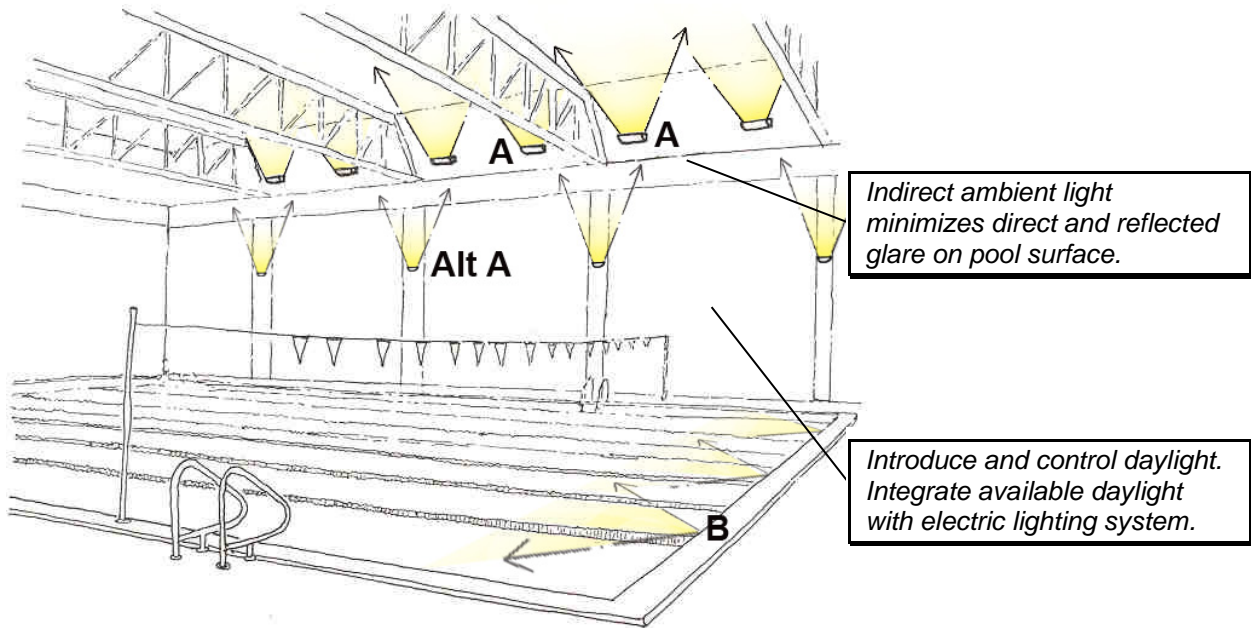

EQUIPMENT REQUIREMENTS:

	LUMINAIRE	LIGHT SOURCE	CONTROLS per ASHRAE (refer to General Building Requirements for clarification)
A	Wall mounted upright.	LED, fluorescent, or induction.	Manual on. General lighting in daylighted areas separately controlled through multilevel photocontrol (step dimming or continuous dimming) to reduce light output when daylight is available, with at least one control step between 50% and 70% of design lighting power and one control step that is no greater than 35% (including off) of design lighting power. Provide manual control device to independently control general lighting with at least one control step between 30% and 70% of design lighting power in addition to all off. Manual off.
B	Pool Basin	LED, fluorescent	Manual on. Manual off.

PERFORMANCE REQUIREMENTS:

Target Criteria	Recreational
<i>Horizontal Illuminance (Average $\pm 10\%$)</i>	<i>30 fc (300 lux) at water surface</i>
<i>Horizontal Illuminance Uniformity</i>	<i>3:1 maximum to minimum</i>

For other classes of play, see IES RP-6.

CRITICAL DESIGN ISSUES:

- Locate underwater luminaires 2-3 feet (0.61 to 0.91 meters) below the water surface on the long sides of the pool.
- Provide luminaires with lenses or louvers to minimize glare.
- Locate luminaires to allow for an adequate portion of the incident light to penetrate the water and not be reflected into eyes of the observer. Locate luminaires along pool edge for ease of maintenance. Do not locate luminaires inside a 20-degree cone extending above the diving platform.
- Light room surfaces to balance out luminance ratios.
- Coordinate with architect for shading devices that eliminate direct sunlight.

3-8.2 Indoor Tennis Courts.

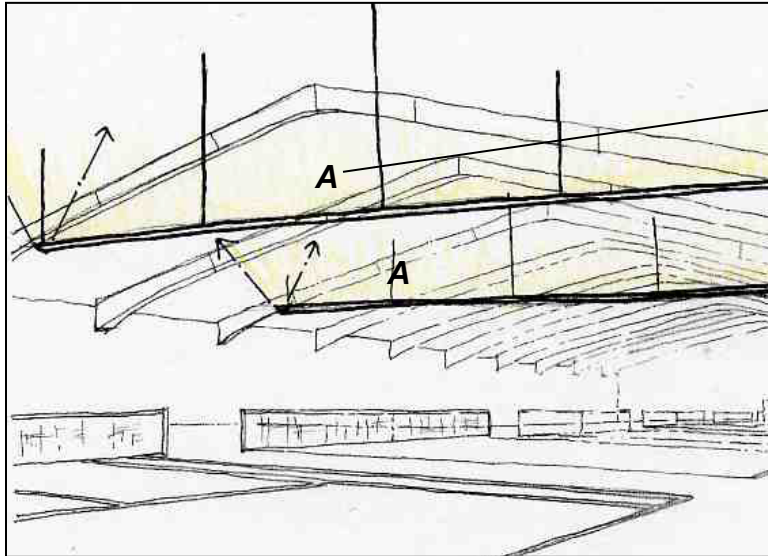

Suspended indirect ambient light minimizes shadowing and prevents direct glare.

Introduce and control daylight. Integrate available daylight with electric lighting system.

EQUIPMENT REQUIREMENTS:

	LUMINAIRE	LIGHT SOURCE	CONTROLS per ASHRAE (refer to General Building Requirements for clarification)
A	<i>Suspended linear indirect/direct luminaire.</i>	<i>LED or fluorescent.</i>	<i>Manual on. General lighting in daylighted areas separately controlled through multilevel photocontrol (step dimming or continuous dimming) to reduce light output when daylight is available, with at least one control step between 50% and 70% of design lighting power and one control step that is no greater than 35% (including off) of design lighting power. Provide manual control device to independently control general lighting with at least one control step between 30% and 70% of design lighting power in addition to all off. Manual off.</i>

PERFORMANCE REQUIREMENTS:

Target Criteria	Recreational
<i>Horizontal Illuminance (Average ±10%)</i>	<i>50 fc (500 lux)</i>
<i>Vertical Illuminance (Average ±10%)</i>	<i>15 fc (150 lux)</i>
<i>Horizontal Illuminance Uniformity</i>	<i>2:1 maximum to minimum</i>

For other classes of play, see IES RP-6.

CRITICAL DESIGN ISSUES:

- Provide luminaires with lenses or louvers to minimize glare.
- Provide uniform illuminance on the court.
- Light room surfaces to balance out luminance ratios.
- Coordinate with architect for shading devices that eliminate direct sunlight.

3-8.3 Indoor Basketball Courts.

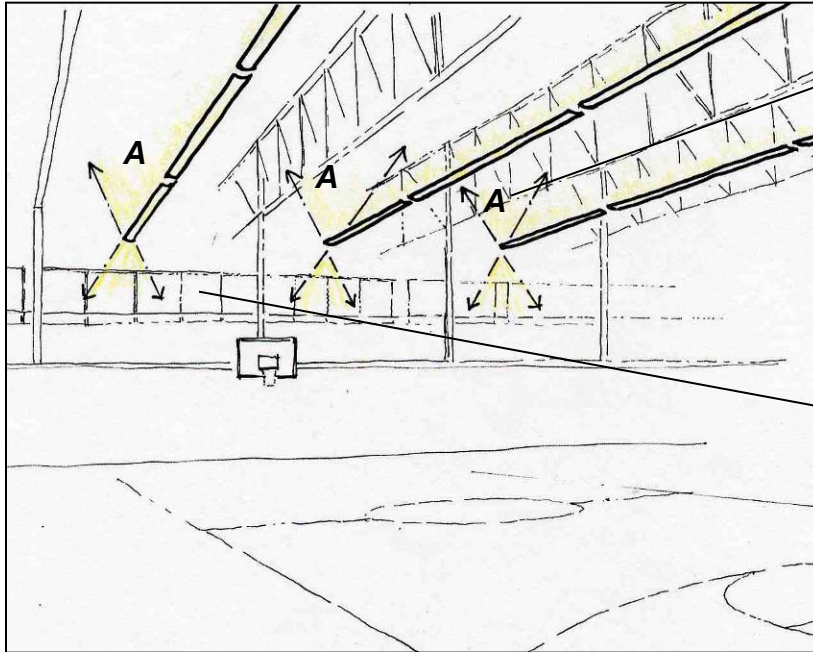

Suspended direct/ indirect lights minimize shadowing and prevent direct glare.

Introduce and control daylight. Integrate available daylight with electric lighting system.

EQUIPMENT REQUIREMENTS:

	LUMINAIRE	LIGHT SOURCE	CONTROLS per ASHRAE (refer to General Building Requirements for clarification)
A	<i>Suspended linear luminaire (50% direct / 50% indirect).</i>	<i>LED or fluorescent.</i>	<p><i>Manual on.</i></p> <p><i>General lighting in daylighted areas separately controlled through multilevel photocontrol (step dimming or continuous dimming) to reduce light output when daylight is available, with at least one control step between 50% and 70% of design lighting power and one control step that is no greater than 35% (including off) of design lighting power.</i></p> <p><i>Provide manual control device to independently control general lighting with at least one control step between 30% and 70% of design lighting power in addition to all off.</i></p> <p><i>Manual off.</i></p>

PERFORMANCE REQUIREMENTS:

Target Criteria	Recreational
<i>Horizontal Illuminance (Average $\pm 10\%$)</i>	<i>30 fc (300 lux)</i>
<i>Vertical Illuminance (Average $\pm 10\%$)</i>	<i>10 fc (100 lux)</i>
<i>Horizontal Illuminance Uniformity</i>	<i>4:1 maximum to minimum</i>

For other classes of play, see IES RP-6.

CRITICAL DESIGN ISSUES:

- Provide luminaires with lenses or louvers to minimize glare.
- Provide uniform illuminance on the court.
- Minimize shadows to enhance view of the ball and other players.
- Light room surfaces to balance out luminance ratios.
- Coordinate with architect for shading devices that eliminate direct sunlight.

3-8.4 Locker Rooms.

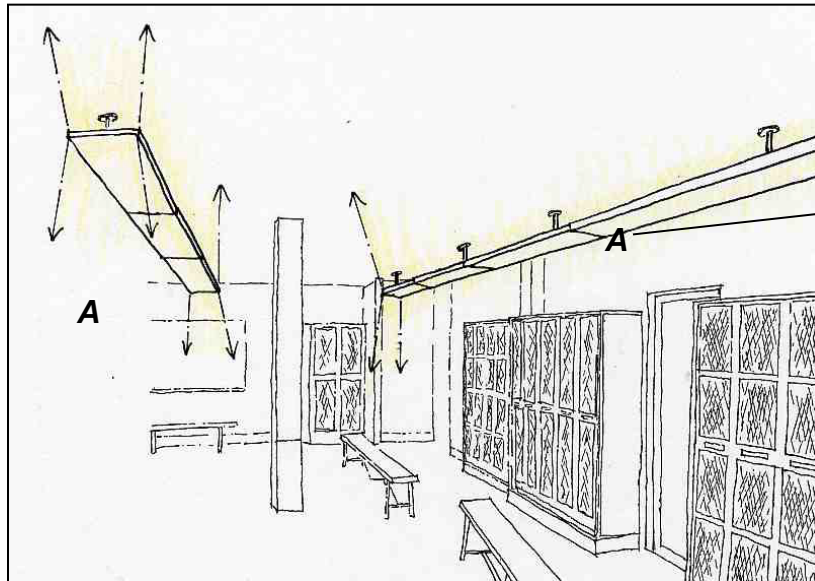

Suspended direct / indirect luminaire.

EQUIPMENT REQUIREMENTS:

	LUMINAIRE	LIGHT SOURCE	CONTROLS per ASHRAE (refer to General Building Requirements for clarification)
A	<i>Suspended linear indirect / direct luminaire.</i>	<i>LED or fluorescent.</i>	<i>Manual on, or auto on (to no more than 50% design lighting power) combined with manual on switching, when occupant enters room.</i>
A ALT	<i>Surface mounted linear strip on top of lockers.</i>	<i>LED or fluorescent.</i>	<i>Provide manual control device to independently control general lighting with at least one control step between 30% and 70% of design lighting power in addition to all off. Automatic off within 15 minutes of no occupant activity.</i>

PERFORMANCE REQUIREMENTS:

Target Criteria	Daytime	Nighttime
<i>Horizontal Illuminance (Average ±10%)</i>	<i>15 fc (150 lux) at floor</i>	
<i>Vertical Illuminance (Average ±10%)</i>	<i>5 fc (50 lux) at locker faces</i>	
<i>Horizontal Illuminance Uniformity</i>	<i>2:1 average to minimum</i>	

CRITICAL DESIGN ISSUES:

- Light room surfaces to balance out luminance ratios.

11

3-9 MAINTENANCE SPACES.

3-9.1 Vehicle Maintenance Areas.

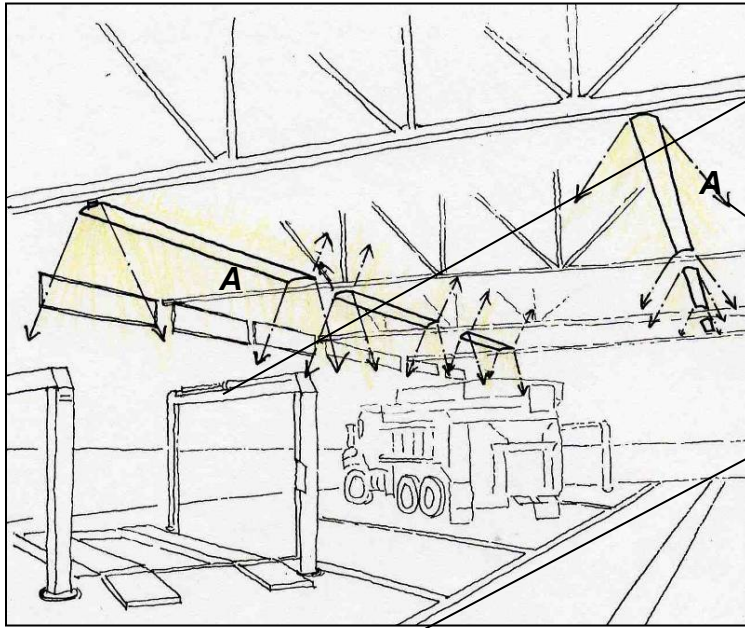

Introduce and control daylight. Integrate with electric lighting controls to reduce energy use.

Direct / indirect luminaire reduces direct glare.

Luminaire spacing provides uniform illuminance on task plane.

EQUIPMENT REQUIREMENTS:

	LUMINAIRE	LIGHT SOURCE	CONTROLS per ASHRAE (refer to General Building Requirements for clarification)
A	<i>Suspended linear direct / indirect luminaire.</i>	<i>LED or fluorescent.</i>	<i>Manual on. General lighting in daylighted areas separately controlled through multilevel photocontrol (step dimming or continuous dimming) to reduce light output when daylight is available, with at least one control step between 50% and 70% of design lighting power and one control step that is no greater than 35% (including off) of design lighting power. Provide manual control device to independently control general lighting with at least one control step between 30% and 70% of design lighting power in addition to all off. Manual off. Each control device must control a maximum of 2,500 sf area for a space 10,000 sf or less and a maximum of 10,000 sf area for a space greater than 10,000 sf.</i>
A ALT	<i>Surface / pendant mounted low bay luminaire.</i>	<i>LED or induction.</i>	
B	<i>Portable task lighting.</i>	<i>LED or fluorescent.</i>	<i>Control device integral to luminaire or controlled by wall mounted control device provided it is located so occupant can see controlled lighting. Manual on. Manual off.</i>

PERFORMANCE REQUIREMENTS:

Target Criteria	Daytime	Nighttime
<i>Horizontal Illuminance (Average ±10%)</i>	<i>1\150 fc (500 lux)/1/</i>	
<i>Vertical Illuminance (Average ±10%)</i>	<i>1\130 fc (300 lux)/1/</i>	
<i>Horizontal Illuminance Uniformity</i>	<i>1\1.5:1 maximum to minimum/1/</i>	

1\

CRITICAL DESIGN ISSUES:

- Locate lighting equipment to minimize shadows.
- Light room surfaces to balance out luminance ratios.
- Uniformly light the work plane.
- Verify special lighting equipment requirements in hazardous (classified) locations.
- These service facilities employ ambient and task lighting systems. The two primary lighting strategies are:
 - Wallmounted luminaires to illuminate tasks (the bench and vehicle hood areas) or
 - Strategically located luminaires at the ceiling at the tasks (hood areas).
- White ceilings and walls are necessary to maximize efficiency and diffusion.

/1/

3-9.2 Aircraft Hangars and Shelters.

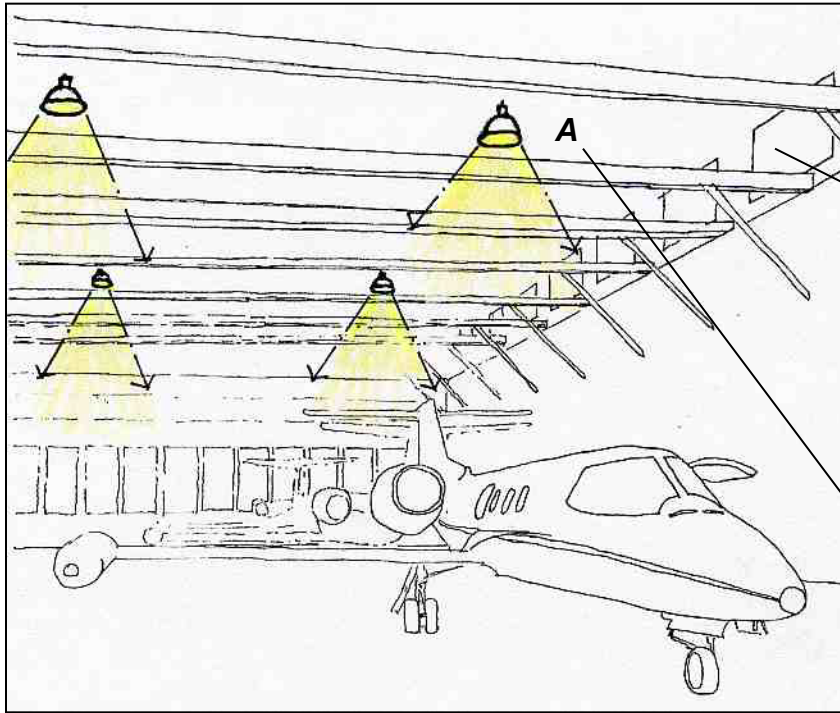

Introduce and control daylight. Integrate with electric lighting system to reduce energy use.

Luminaires with a small uplight component help to reduce contrast between ceiling and luminaire.

EQUIPMENT REQUIREMENTS:

	LUMINAIRE	LIGHT SOURCE	CONTROLS per ASHRAE (refer to General Building Requirements for clarification)
A	Suspended luminaire.	LED, fluorescent, or induction light sources.	Manual on, or auto on to full design lighting power combined with manual on switching, when occupant enters room.
A ALT	Suspended linear luminaire with small uplight component.	LED or fluorescent.	General lighting in daylighted areas separately controlled through multilevel photocontrol (step dimming or continuous dimming) to reduce light output when daylight is available, with at least one control step between 50% and 70% of design lighting power and one control step that is no greater than 35% (including off) of design lighting power. Provide manual control device to independently control general lighting with at least one control step between 30% and 70% of design lighting power in addition to all off. Automatic off within 15 minutes of no occupant activity. Each control device must control a maximum of 2500sft area for a space 10,000 sf or less and a maximum of 10000sft area for a space greater than 10,000 sf.

B	<i>Portable task lighting.</i>	<i>LED or fluorescent.</i>	<i>Control device integral to luminaire or controlled by wall mounted control device provided it is located so occupant can see controlled lighting. Manual on. Manual off.</i>
----------	--------------------------------	----------------------------	---

PERFORMANCE REQUIREMENTS:

Target Criteria	Daytime	Nighttime
<i>Horizontal Illuminance (Average ±10%)</i>	<i>50 fc (500 lux) at 2'-6" (762mm) AFF</i>	
<i>Vertical Illuminance (Average ±10%)</i>	<i>15 fc (150 lux) at 3'-6" (1067mm) AFF</i>	
<i>Horizontal Illuminance Uniformity</i>	<i>3:1 average to minimum</i>	

CRITICAL DESIGN ISSUES:

- Locate lighting equipment to minimize shadows.
- Uniformly light the work plane.
- Verify special lighting equipment requirements in hazardous (classified) locations.

3-9.3 Motorpools.

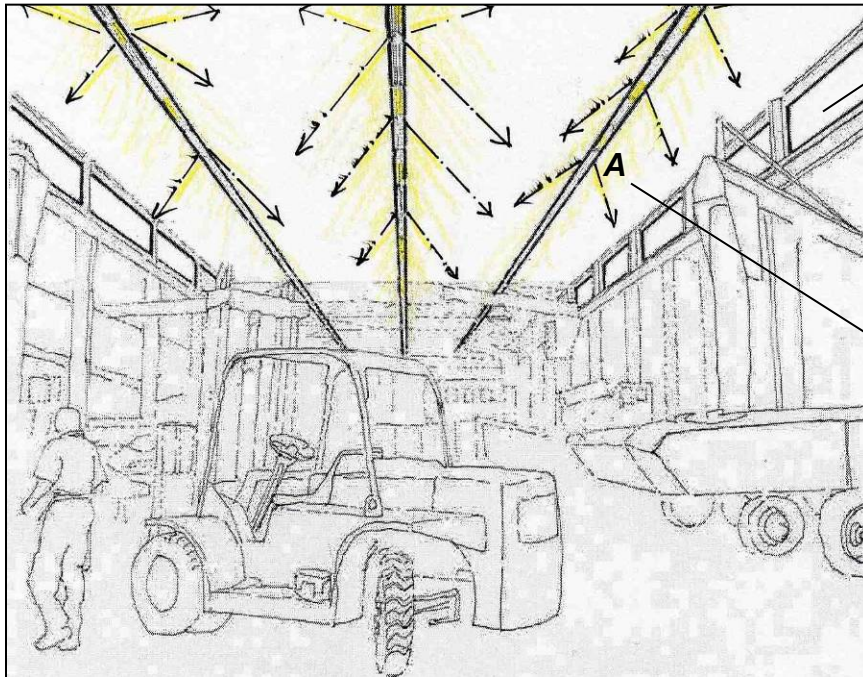

Introduce daylight on north and south facades and control glare.

Surface or suspended direct / indirect industrial strips.

EQUIPMENT REQUIREMENTS:

	LUMINAIRE	LIGHT SOURCE	CONTROLS per ASHRAE (refer to General Building Requirements for clarification)
A	Surface mounted or suspended industrial luminaire.	LED or fluorescent.	Manual on, or auto on to full design lighting power combined with manual on switching, when occupant enters room. General lighting in daylighted areas separately controlled through multilevel photocontrol (step dimming or continuous dimming) to reduce light output when daylight is available, with at least one control step between 50% and 70% of design lighting power and one control step that is no greater than 35% (including off) of design lighting power.
A ALT	Surface or pendant-mounted low bay luminaire.	LED or induction.	Provide manual control device to independently control general lighting with at least one control step between 30% and 70% of design lighting power in addition to all off. Automatic off within 15 minutes of no occupant activity. Each control device must control a maximum of 2,500 sf area for a space 10,000 sf or less and a maximum of 10,000 sf area for a space greater than 10,000 sf.
B	Portable task lighting.	LED or fluorescent.	Control device integral to luminaire or controlled by wall mounted control device provided it is located so occupant can see controlled lighting. Manual on. Manual off.

PERFORMANCE REQUIREMENTS:

Target Criteria	Daytime	Nighttime
<i>Horizontal Illuminance (Average $\pm 10\%$)</i>	<i>50 fc (500 lux)</i>	
<i>Vertical Illuminance (Average $\pm 10\%$)</i>	<i>15 fc (150 lux)</i>	
<i>Horizontal Illuminance Uniformity</i>	<i>3:1 maximum to minimum</i>	

CRITICAL DESIGN ISSUES:

- Locate lighting equipment to minimize shadows.
- Light room surfaces to balance out luminance ratios.
- Uniformly light the work plane.
- Verify special lighting equipment requirements in hazardous (classified) locations.

3-9.4 Warehouses.



Introduce daylight and control glare. Integrate with electric lighting system.

Surface or suspended direct / indirect industrial luminaires.

EQUIPMENT REQUIREMENTS:

	LUMINAIRE	LIGHT SOURCE	CONTROLS per ASHRAE (refer to General Building Requirements for clarification)
A	<i>Suspended industrial luminaire with 5% - 10% uplight.</i>	<i>LED or fluorescent.</i>	<p><i>Manual on, or auto on (to no more than 50% design lighting power) combined with manual on switching, when occupant enters room.</i></p> <p><i>General lighting in daylighted areas separately controlled through multilevel photocontrol (step dimming or continuous dimming) to reduce light output when daylight is available, with at least one control step between 50% and 70% of design lighting power and one control step that is no greater than 35% (including off) of design lighting power.</i></p> <p><i>Provide manual control device to independently control general lighting with at least one control step between 30% and 70% of design lighting power in addition to all off.</i></p> <p><i>Occupancy sensor control reduces design lighting power through multi-level switching or dimming a minimum of 50% within 15 minutes of no occupant activity.</i></p> <p><i>Each control device must control a maximum of 2,500 sf area for a space 10,000 sf or less and a maximum of 10,000 sf area for a space greater than 10,000 sf.</i></p> <p><i>Automatic off within 15 minutes of normal closing.</i></p>
A ALT	<i>Surface mounted low bay luminaire.</i>	<i>LED or induction.</i>	

PERFORMANCE REQUIREMENTS:

Target Criteria	Active	Inactive
<i>Horizontal Illuminance (Average ±10%)</i>	<i>30 fc (300 lux)</i>	<i>5 fc (50 lux)</i>
<i>Vertical Illuminance (Average ±10%)</i>	<i>15 fc (150 lux)</i>	<i>2 fc (20 lux)</i>
<i>Horizontal Illuminance Uniformity</i>	<i>3:1 average to minimum</i>	<i>5:1 average to minimum</i>

CRITICAL DESIGN ISSUES:

- Locate lighting equipment to minimize shadows.
- Light room surfaces to balance out luminance ratios.
- Uniformly light the work plane.
- Coordinate with architect for shading devices that eliminate direct sunlight.

3-10 RESIDENTIAL HOUSING.

3-10.1 Bedrooms.

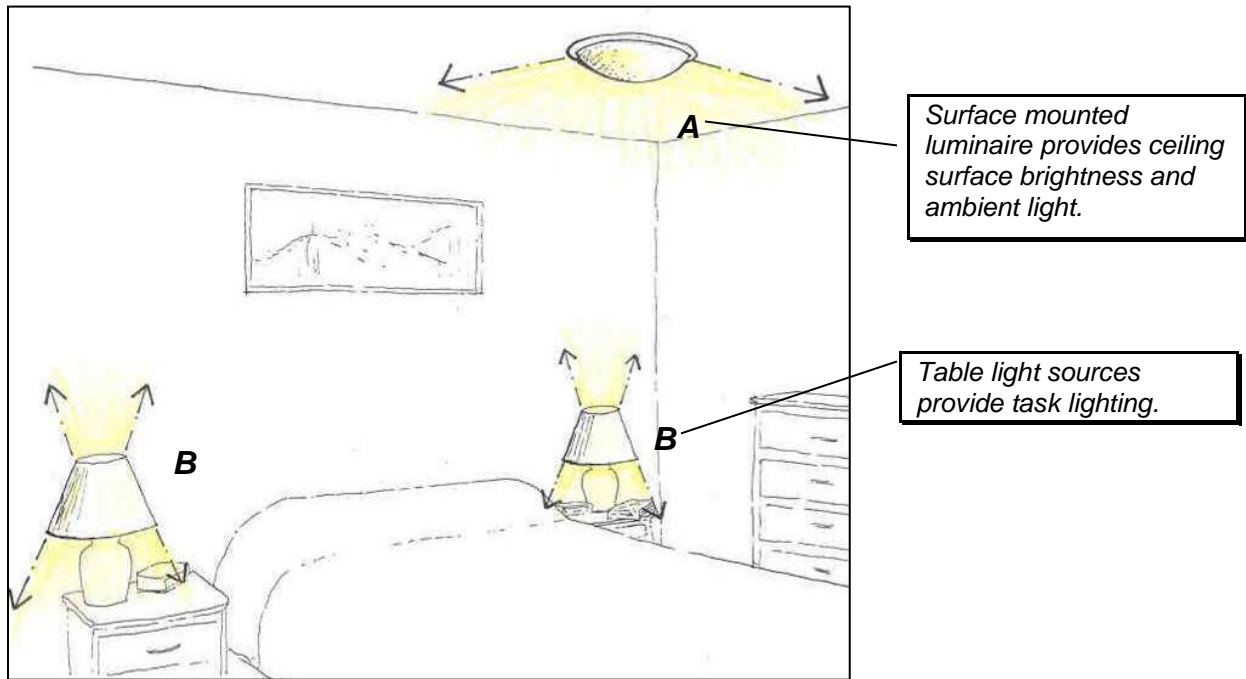

EQUIPMENT REQUIREMENTS:

	LUMINAIRE	LIGHT SOURCE	CONTROLS
A	Surface mounted luminaire.	LED or fluorescent 2700K – 3000K.	Manual on Manual off.
A ALT	Wall mounted sconce.	LED or fluorescent 2700K – 3000K.	Manual on Manual off.
B	Table lamp.	LED or fluorescent 2700K – 3000K.	Manual on Manual off.

PERFORMANCE REQUIREMENTS:

Target Criteria	Daytime	Nighttime
Horizontal Illuminance (Average $\pm 10\%$)	5 fc (50 lux) at 2'-0" (610mm) AFF	
Vertical Illuminance (Average $\pm 10\%$)	3 fc (30 lux) at 4'-0" (1219mm) AFF	
Horizontal Illuminance Uniformity	3:1 average to minimum	

CRITICAL DESIGN ISSUES:

- Light room surfaces to balance out luminance ratios.

3-10.2 Hallways.

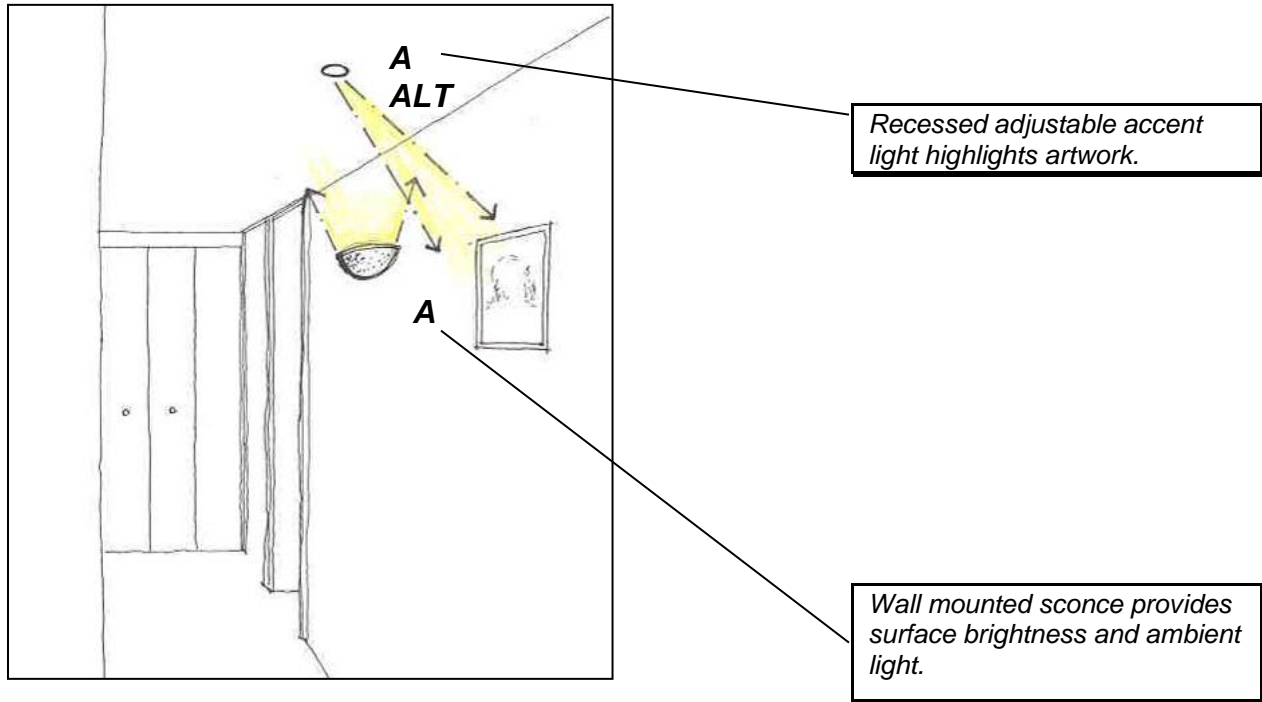

EQUIPMENT REQUIREMENTS:

	LUMINAIRE	LIGHT SOURCE	CONTROLS
A	Wall mounted sconce.	LED or fluorescent.	Manual on. Dim as separate zone or part of scene controller. Automatic off within 5 minutes of no occupant activity, combined with manual switching
A ALT	Recessed or surface mounted accent light.	LED or tungsten halogen.	
A ALT	Surface mounted luminaire.	LED or fluorescent.	

PERFORMANCE REQUIREMENTS:

Target Criteria	Daytime	Nighttime
Horizontal Illuminance (Average ±10%)	3 fc (30 lux) at floor	
Vertical Illuminance (Average ±10%)	0.6 fc (6 lux) at 5'-0" (1524mm) AFF	
Horizontal Illuminance Uniformity	5:1 average to minimum	

3-10.3 Laundry Rooms.

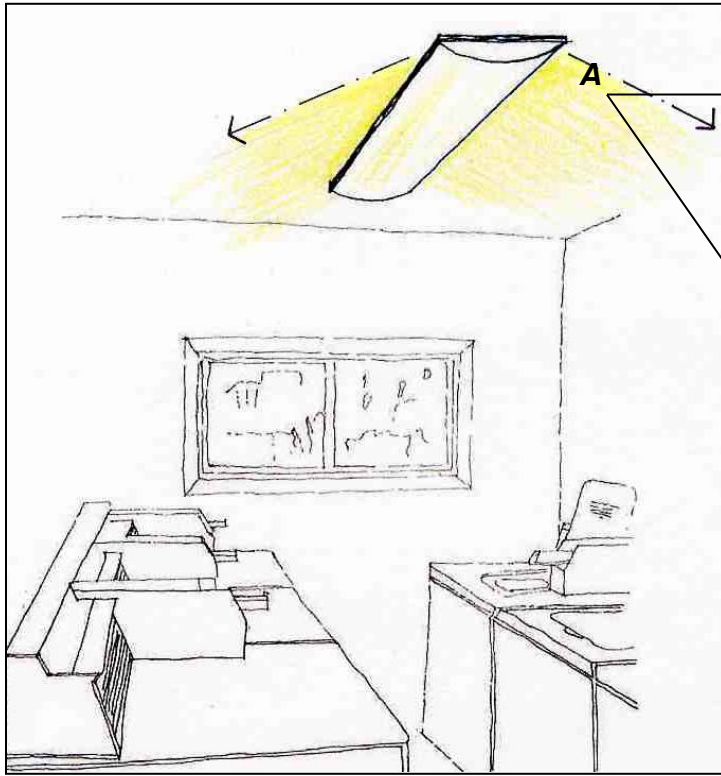

Surface mounted luminaire adds brightness to the ceiling.

Light sources with good color-rendering characteristics provide good color appearance and contrast in the space.

EQUIPMENT REQUIREMENTS:

	LUMINAIRE	LIGHT SOURCE	CONTROLS
A	Surface mounted linear luminaire.	LED or fluorescent.	Automatic on Vacancy off

PERFORMANCE REQUIREMENTS:

Target Criteria	Daytime	Nighttime
Horizontal Illuminance (Average $\pm 10\%$)	20 fc (200 lux) at 3'-0" (914mm) AFF	
Vertical Illuminance (Average $\pm 10\%$)	5 fc (50 lux) at 3'-0" (914mm) AFF	
Horizontal Illuminance Uniformity	2:1 average to minimum	

3-10.4 Kitchens.

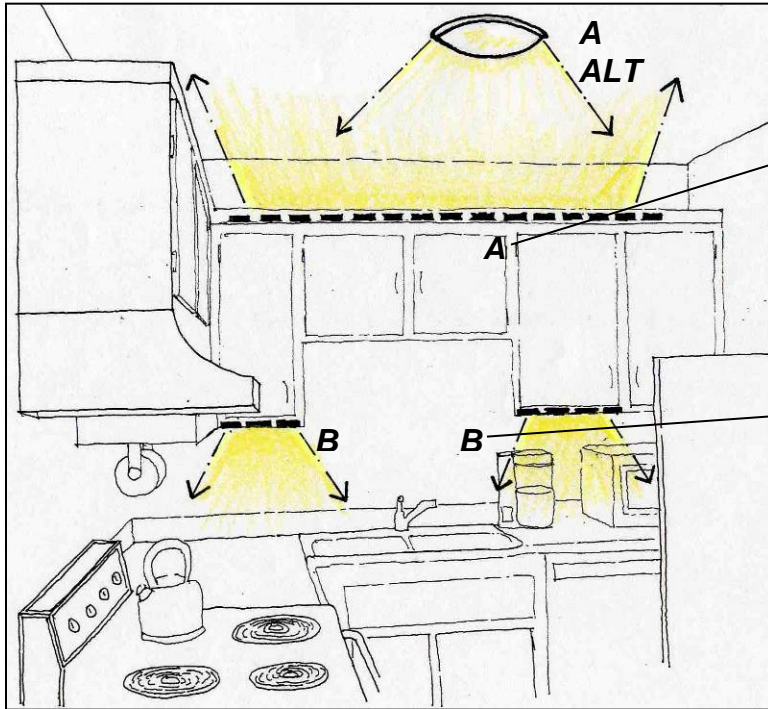

Concealed strips uplight the ceiling. (Ceiling brightness could also be achieved with a surface mounted luminaire.)

Undercabinet tasklights illuminate countertop.

Introduce daylight with the use of windows, skylights, or light tubes. Provide controls to turn off lighting that is not required.

EQUIPMENT REQUIREMENTS:

	LUMINAIRE	LIGHT SOURCE	CONTROLS
A	Surface mounted linear strip.	LED or fluorescent 2700K – 3000K.	Manual on. Dim as separate zone or part of scene controller. Manual off.
A ALT	Ceiling mounted luminaire.	LED, fluorescent 2700K – 3000K.	Manual on. Dim as separate zone or part of scene controller. Manual off.
B	Surface mounted undercabinet tasklight.	LED or fluorescent.	Manual on. Dim as separate zone or part of scene controller. Manual off.
B ALT	Surface mounted linear or surface/recessed puck.	LED.	Manual on. Dim as separate zone or part of scene controller. Manual off.

PERFORMANCE REQUIREMENTS:

Target Criteria	Daytime	Nighttime
<i>Horizontal Illuminance (Average $\pm 10\%$)</i>	<i>30 fc (300 lux) at cooking service</i>	
<i>Vertical Illuminance (Average $\pm 10\%$)</i>	<i>5 fc (50 lux) at cooking service</i>	
<i>Horizontal Illuminance Uniformity</i>	<i>2:1 average to minimum</i>	

CRITICAL DESIGN ISSUES:

- Locate lighting equipment to minimize shadows.
- Light room surfaces to balance out luminance ratios.

3-10.5 Dining Room.

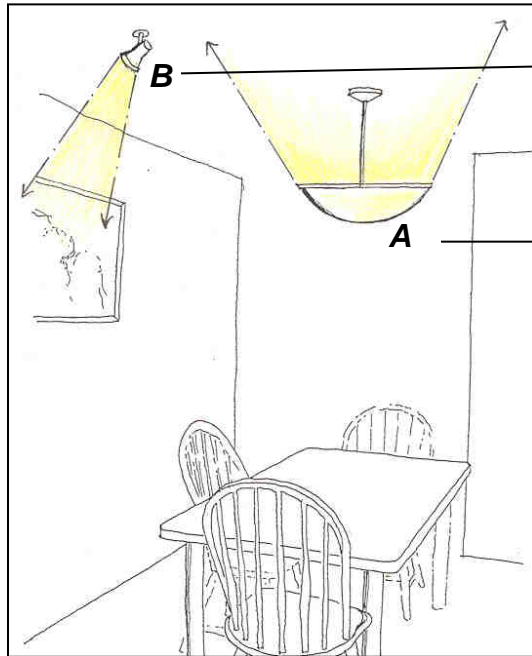

Adjustable accent light highlights artwork.

Suspended decorative luminaire lights ceiling and provides ambient lighting.

Introduce daylight with the use of windows or skylights.

EQUIPMENT REQUIREMENTS:

	LUMINAIRE	LIGHT SOURCE	CONTROLS
A	Suspended luminaire.	LED or fluorescent 2700K – 3000K.	Manual on. Dim as separate zone or part of scene controller. Manual off.
A ALT	Ceiling mounted luminaire.	LED or fluorescent 2700K – 3000K.	Manual on. Dim as separate zone or part of scene controller. Manual off.
B	Recessed or monopoint mounted adjustable accent light.	LED or fluorescent 2700K – 3000K directional.	Manual on. Dim as separate zone or part of scene controller. Manual off.

PERFORMANCE REQUIREMENTS:

Target Criteria	Daytime	Nighttime
Horizontal Illuminance (Average ±10%)	5 fc (50 lux) at table plane	
Vertical Illuminance (Average ±10%)	2 fc (20 lux) at 4'-0" (1219mm) AFF	
Horizontal Illuminance Uniformity	4:1 average to minimum	

3-10.6 Living Rooms.

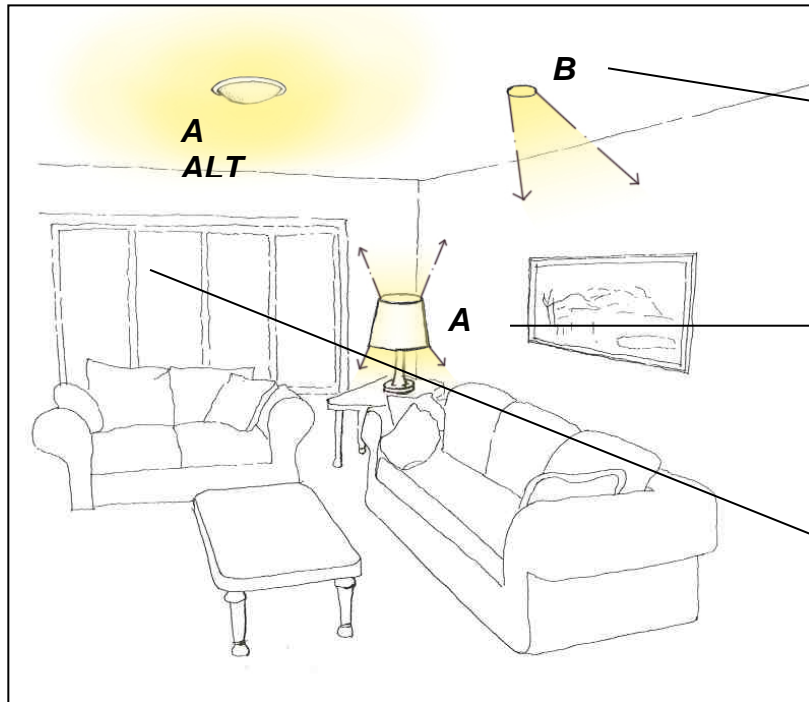

Recessed accent lights provide wall brightness and highlighting of art or features.

Table light sources provide task light.

Introduce daylight with the use of windows or skylights. Provide controls to turn off and dim lighting that is not required.

EQUIPMENT REQUIREMENTS:

	LUMINAIRE	LIGHT SOURCE	CONTROLS
A	Table lamp.	LED or fluorescent 2700K – 3000K.	Manual on. Manual off.
A ALT	Floor light source or torchiere.	LED or fluorescent 2700K – 3000K.	Manual on. Manual off.
A ALT	Wall mounted uplight.	LED or fluorescent 2700K – 3000K.	Manual on. Dim as separate zone or part of scene controller. Manual off.
A ALT	Ceiling mounted area light.	LED or fluorescent 2700K – 3000K.	Manual on. Dim as separate zone or part of scene controller. Manual off.
B	Recessed wall washer or adjustable accent light.	LED or fluorescent 2700K – 3000K or tungsten halogen directional.	Manual on. Dim as separate zone or part of scene controller. Manual off.

PERFORMANCE REQUIREMENTS:

Target Criteria	Daytime	Nighttime
<i>Horizontal Illuminance (Average $\pm 10\%$)</i>	<i>3 fc (30 lux) at floor</i>	
<i>Vertical Illuminance (Average $\pm 10\%$)</i>	<i>3 fc (30 lux) at 4'-0" (1219mm) AFF</i>	
<i>Horizontal Illuminance Uniformity</i>	<i>5:1 average to minimum</i>	

3-10.7 Rec Rooms.

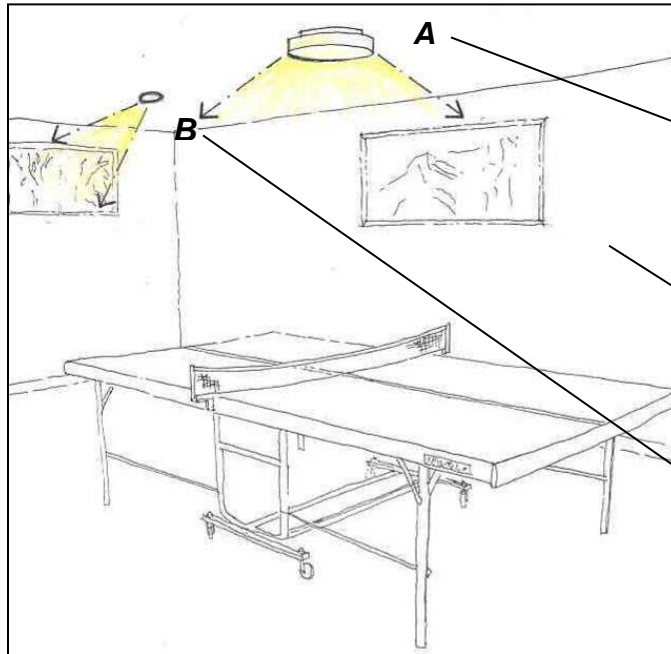

Surface mounted luminaire lights activities and provides ceiling brightness.

Introduce daylight with the use of windows, skylights, or light tubes. Provide controls to turn off and dim lighting that is not required.

Recessed adjustable accent light highlights artwork.

EQUIPMENT REQUIREMENTS:

	LUMINAIRE	LIGHT SOURCE	CONTROLS
A	<i>Ceiling mounted luminaire.</i>	<i>LED or fluorescent 2700K – 3000K.</i>	<i>Manual on. Dim as separate zone or part of scene controller. Automatic off within 5 minutes of no occupant activity, combined with manual switching.</i>
B	<i>Recessed wall washer or adjustable accent light.</i>	<i>LED or fluorescent 2700K – 3000K or tungsten halogen directional.</i>	<i>Manual on. Dim as separate zone or part of scene controller. Automatic off within 5 minutes of no occupant activity, combined with manual switching.</i>

PERFORMANCE REQUIREMENTS:

Target Criteria	Daytime	Nighttime
<i>Horizontal Illuminance (Average ±10%)</i>	<i>20 fc (200 lux) at 2'-6" (762mm) AFF</i>	
<i>Vertical Illuminance (Average ±10%)</i>	<i>5 fc (50 lux) at 4'-0" (1219mm) AFF</i>	
<i>Horizontal Illuminance Uniformity</i>	<i>2:1 average to minimum</i>	

3-10.8 Bathrooms.

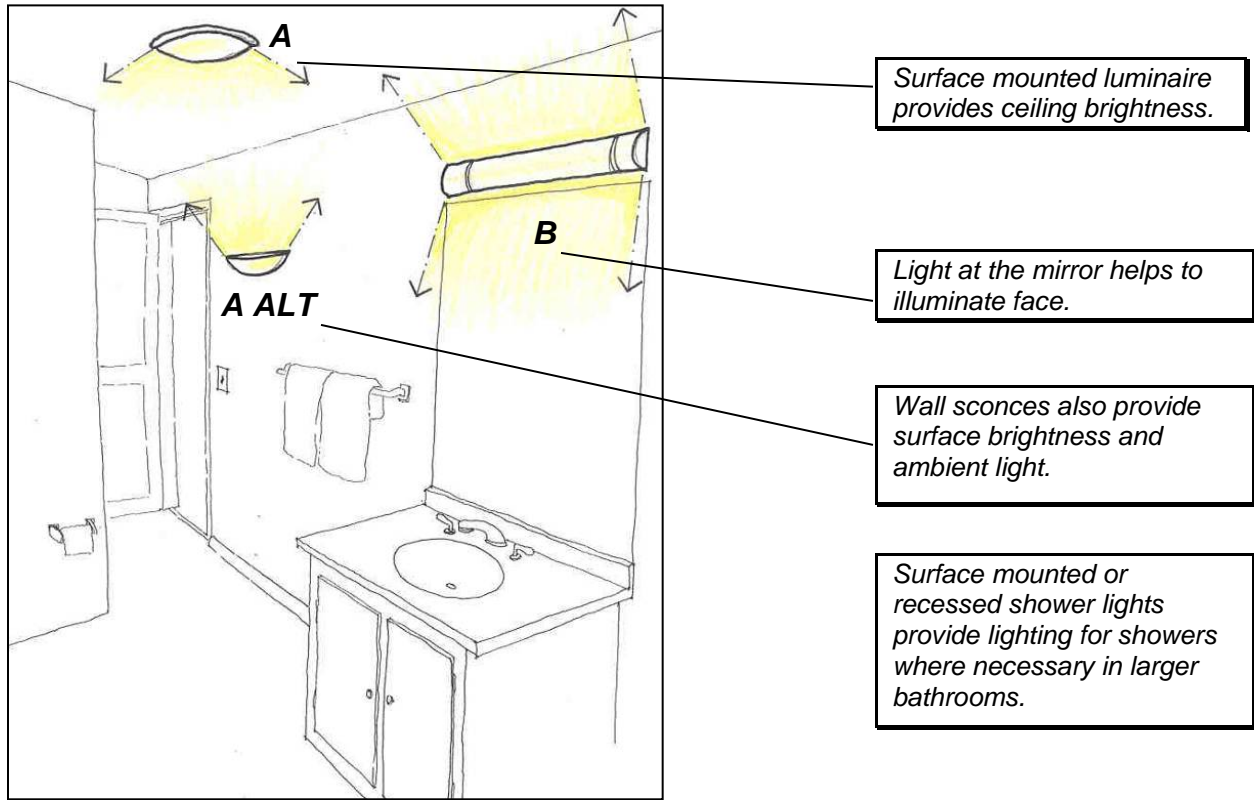

EQUIPMENT REQUIREMENTS:

	LUMINAIRE	LIGHT SOURCE	CONTROLS
A	Surface mounted luminaire.	LED or fluorescent 2700K – 3000K.	Manual on. Dim as separate zone or part of scene controller. Manual off.
A ALT	Wall mounted sconce.	LED or fluorescent 2700K – 3000K.	
B	Wall mounted linear vanity light.	LED or fluorescent 2700K – 3000K.	
C	Surface mounted or recessed shower light.	LED or fluorescent 2700K – 3500K.	

PERFORMANCE REQUIREMENTS:

Target Criteria	Daytime	Nighttime
Horizontal Illuminance (Average ±10%)	30 fc (300 lux) at 3'-0" (914mm) AFF	
Vertical Illuminance (Average ±10%)	40 fc (400 lux) at 5'-0" (1524mm) AFF	
Horizontal Illuminance Uniformity	2:1 average to minimum	

3-10.9 Garages.

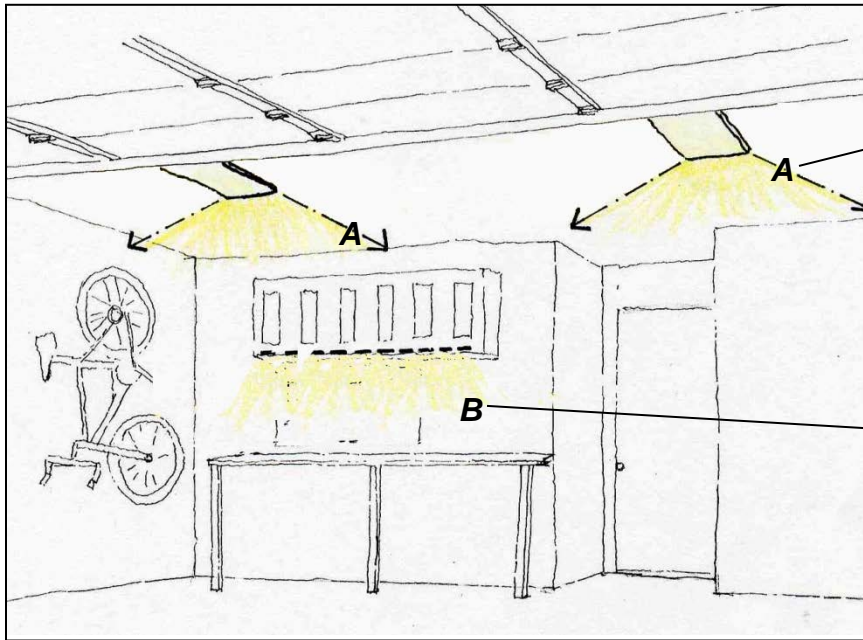

Lensed luminaires provide high ambient light levels while minimizing direct glare. Luminaires are located so that garage door does not block light.

Additional task lighting under cabinets lights workbench.

EQUIPMENT REQUIREMENTS:

	LUMINAIRE	LIGHT SOURCE	CONTROLS
A	Surface mounted linear luminaire.	LED or fluorescent.	Manual on. Automatic off within 5 minutes of no occupant activity, combined with manual switching.
B	Surface mounted linear tasklight.	LED or fluorescent.	Manual on. Automatic off within 5 minutes of no occupant activity, combined with manual switching.

PERFORMANCE REQUIREMENTS:

Target Criteria	Daytime	Nighttime
Horizontal Illuminance (Average $\pm 10\%$)	20 fc (200 lux) at 3'-0" (914mm) AFF	
Vertical Illuminance (Average $\pm 10\%$)	10 fc (100 lux) at 3'-0" (914mm) AFF	
Horizontal Illuminance Uniformity	3:1 average to minimum	

3-11 HOUSING.

3-11.1 Bachelors Quarters (Barracks).

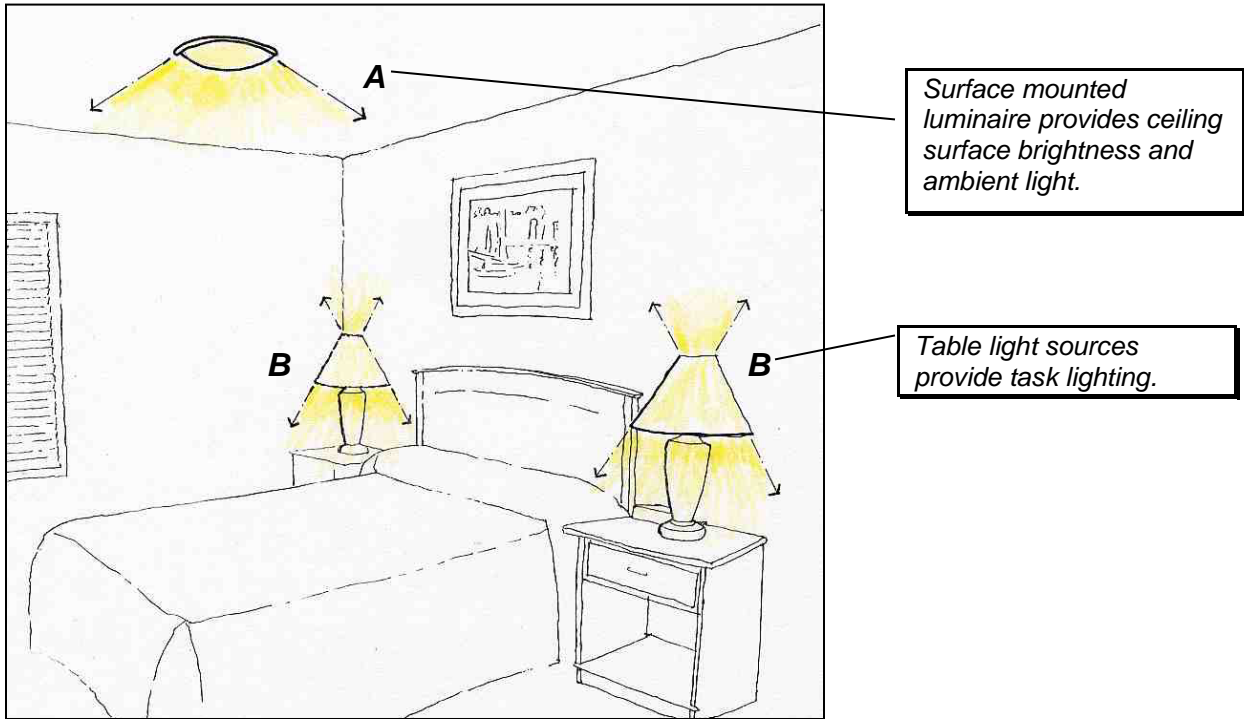

EQUIPMENT REQUIREMENTS:

	LUMINAIRE	LIGHT SOURCE	CONTROLS
A	Surface mounted luminaire.	LED or fluorescent 2700K – 3000K.	Manual on Manual off.
A ALT	Wall mounted sconce.	LED or fluorescent 2700K – 3000K.	Manual on Manual off.
B	Table lamp.	LED or fluorescent 2700K – 3000K.	Manual on Manual off.

PERFORMANCE REQUIREMENTS:

Target Criteria	Daytime	Nighttime
Horizontal Illuminance (Average ±10%)	5 fc (50 lux) at 2'-0" (910mm) AFF	
Vertical Illuminance (Average ±10%)	3 fc (30 lux) at 4'-0" (1219mm) AFF	
Horizontal Illuminance Uniformity	3:1 average to minimum	

3-12 CHILDCARE SPACES.

3-12.1 Daycare Indoor Play Areas.

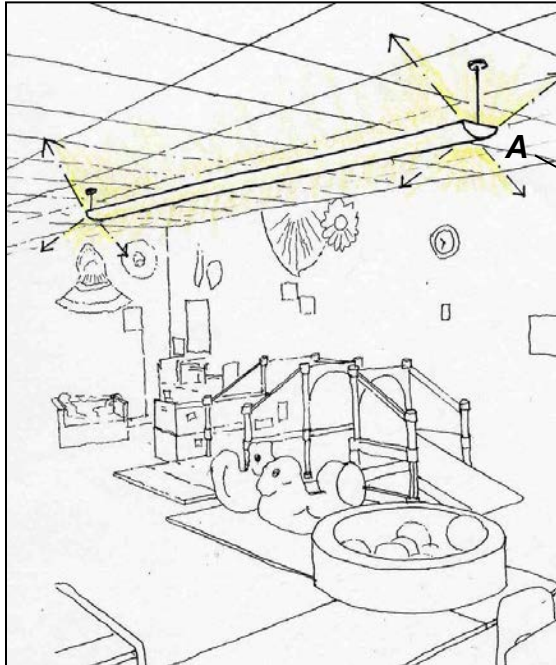

Introduce and control daylight. Daylighting strategies should also provide views to the outdoors.

Suspended indirect / direct linear luminaire.

EQUIPMENT REQUIREMENTS:

	LUMINAIRE	LIGHT SOURCE	CONTROLS per ASHRAE (refer to General Building Requirements for clarification)
A	<i>Suspended indirect / direct linear luminaire.</i>	<i>LED or fluorescent.</i>	<i>Manual on, or auto on (to no more than 50% design lighting power) combined with manual on switching, when occupant enters room.</i>
A ALT	<i>Surface mounted luminaire.</i>	<i>LED or fluorescent.</i>	<i>General lighting in daylighted areas separately controlled through multilevel photocontrol (step dimming or continuous dimming) to reduce light output when daylight is available, with at least one control step between 50% and 70% of design lighting power and one control step that is no greater than 35% (including off) of design lighting power. Provide manual control device to independently control general lighting with at least one control step between 30% and 70% of design lighting power in addition to all off. Automatic off within 15 minutes of no occupant activity.</i>

PERFORMANCE REQUIREMENTS:

Target Criteria	Daytime	Nighttime
<i>Horizontal Illuminance (Average ±10%)</i>	<i>30 fc (300 lux) at 2'-0" (910mm) AFF</i>	

3-12.2 Daycare Indoor Rest Areas.

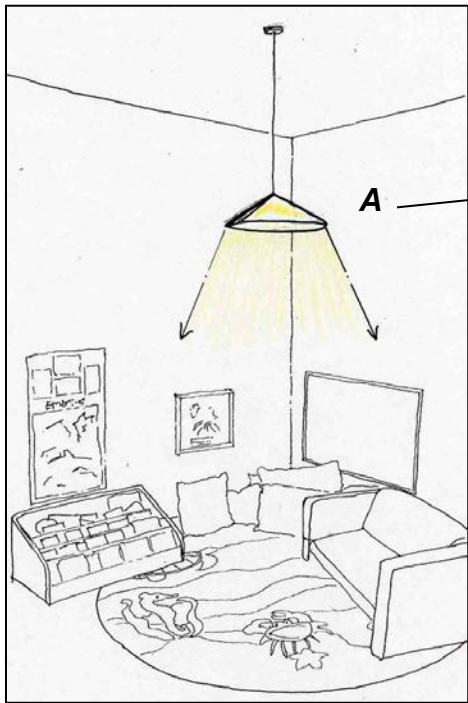

Suspended luminaire lowers the “perceived ceiling” and helps to create a space within a larger space.

EQUIPMENT REQUIREMENTS:

	LUMINAIRE	LIGHT SOURCE	CONTROLS per ASHRAE (refer to General Building Requirements for clarification)
A	Suspended luminaire.	LED or fluorescent 2700K – 3000K.	Manual on, or auto on (to no more than 50% design lighting power) combined with manual on switching, when occupant enters room. General lighting in daylighted areas separately controlled through multilevel photocontrol (step dimming or continuous dimming) to reduce light output when daylight is available, with at least one control step between 50% and 70% of design lighting power and one control step that is no greater than 35% (including off) of design lighting power. Provide manual control device to independently control general lighting with at least one control step between 30% and 70% of design lighting power in addition to all off. Automatic off within 15 minutes of no occupant activity.
A ALT	Surface mounted luminaire.	LED or fluorescent 2700K – 3000K.	

PERFORMANCE REQUIREMENTS:

Target Criteria	Daytime	Nighttime
Horizontal Illuminance (Average ±10%)	10-20 fc (100-200 lux) at 2'-0" (910mm) AFF	

3-13 PARKING.

3-13.1 Parking Structures.

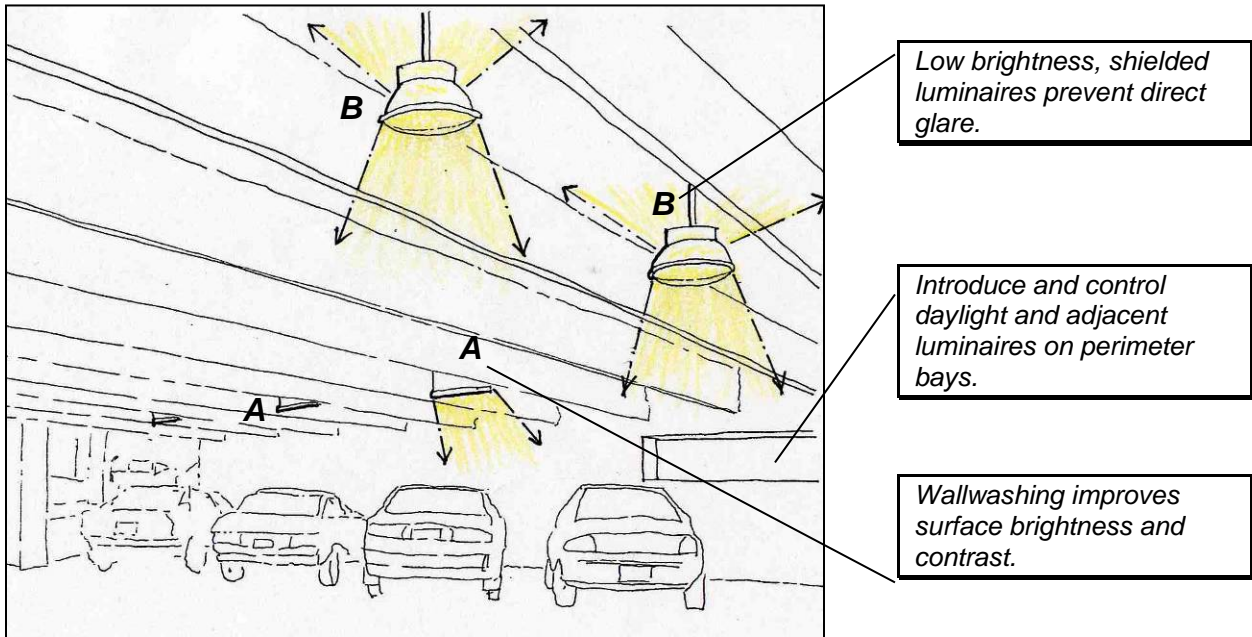

EQUIPMENT REQUIREMENTS:

	LUMINAIRE	LIGHT SOURCE	CONTROLS per ASHRAE (refer to General Building Requirements for clarification)
A	Surface mounted linear wall washers.	LED or fluorescent.	Automatic on to full power when activity is detected in lighting zone. Automatically reduce lighting power by minimum of 30% when no activity is detected within a lighting zone for no more than 30 minutes. These lighting zones must be no larger than 3600sft. Daylight transition zone lighting separately controlled by a device that automatically turns lighting on during daylight hours and off at sunset (except at daylight transition zones and ramps without parking) For luminaires within 20 ft of any perimeter daylight zone power automatically reduced in response to daylight (except at daylight transition zones and ramps without parking).
B	Suspended/ Surface mounted parking garage luminaire.	LED or induction.	
B ALT	Suspended/ Surface mounted parking garage luminaire.	LED or metal halide.	

PERFORMANCE REQUIREMENTS:

Target Criteria	Daytime	Nighttime
<i>Horizontal Illuminance (Minimum ±10%)</i>	<i>1 fc (10 lux) at floor (basic) 2 fc (20 lux) at floor (ramps) 50 fc (500 lux) at floor (entrance) 2 fc (20 lux) at walking surface (stairways)</i>	<i>1 fc (10 lux) at floor (basic) 1 fc (10 lux) at floor (ramps) 50 fc (500 lux) at floor (entrance) 2 fc (20 lux) at walking surface (stairways)</i>
<i>Vertical Illuminance (Minimum ±10%)</i>	<i>0.5 fc (5 lux) at 5'-0" (1.5m) (basic) 1 fc (10 lux) at 5'-0" (1.5m) (ramps) 25 fc (250 lux) at 5'-0" (1.5m) (entrance) 1 fc (10 lux) at walking surface (stairways)</i>	<i>0.5 fc (5 lux) at 5'-0" (1.5m) (basic) 0.5 fc (5 lux) at 5'-0" (1.5m) (ramps) 0.5 fc (5 lux) at 5'-0" (1.5m) (entrance) 1 fc (10 lux) at walking surface (stairways)</i>
<i>Horizontal Illuminance Uniformity</i>	<i>10:1 maximum to minimum</i>	

CHAPTER 4 EXTERIOR LIGHTING AND CONTROLS

4-1 PRIORITIES FOR LIGHTING SYSTEMS.

Design exterior lighting systems to minimize energy consumption, reduce maintenance costs, improve lighting quality on DoD Installations, at the lowest life cycle cost.

4-1.1 Energy Reduction.

Minimize energy consumption by providing energy efficient technologies, effective luminance and illuminance levels, and implementing control strategies.

Solid State Lighting (SSL)/Light Emitting Diode (LED) and induction lighting systems are established technologies for exterior lighting applications that have been proven to save energy over traditional High Intensity Discharge (HID) light sources. Therefore, SSL/LED and induction lighting must be the first consideration for all exterior lighting applications such as building, area, roadway, parking lot, pathway, sidewalk, signage, landscape, and security lighting.

4-1.2 Maintenance Reduction.

Reduce maintenance by technology selection, reducing equipment quantities, and implementing controls strategies.

Select light sources, power supplies, and controls that are rated and warranted for long useful lives to increase the amount of time between maintenance cycles. Match light sources in adjacent areas when appropriate.

4-1.3 Lighting Quality.

Apply the following to ensure the priority of lighting quality is achieved.

4-1.3.1 Direct Glare.

Avoid direct glare from luminaires and excessive contrast of surfaces. Use shielded light sources and as low a wattage as possible.

4-1.3.2 Light Pollution / Trespass.

Use fully shielded or IES U0 luminaires to eliminate direct light above the horizontal plane. Refer to maximum allowable uplight (U) and backlight (B) ratings in specific lighting zones.

4-1.3.3 Modeling of Faces or Objects.

Provide light from multiple directions to accurately render objects and people.

4-1.3.4 Reflected Glare.

Select and locate luminaires to minimize wet surface reflected glare and polished surface reflection of a light source.

4-1.3.5 Shadows.

Locate poles such that the light from the luminaires minimizes shadows that could conceal potential hazards.

4-1.3.6 Vertical Illuminance.

Provide vertical illuminance on individuals' faces as well as potential hazards.

4-1.3.7 Appearance of Space and Luminaires.

Carefully select luminaires to match the aesthetic character of the building and contribute to a welcome designation to the building entry. Refer to the base-wide architectural plan to consolidate luminaire types.

4-1.3.8 Light Distribution on Surfaces.

Illuminate the walkway uniformly to avoid dark patches.

4-1.3.9 Point(s) of Interest.

Provide lighting for wayfinding and indicate points of interests, such as the building entry.

4-1.4 Life Cycle Cost.

Refer to APPENDIX E for an example of a life cycle cost analysis (LCCA). Select lighting systems on the total ownership cost accounting for the following variables:

- Initial Cost
- Energy Cost
- Demand Cost
- Utility Inflation Rate
- Maintenance (Equipment) Cost
- Maintenance (Labor) Cost (including cleaning of luminaire)
- Maintenance Inflation Rate
- Replacement Cost

- Disposal/Recycling Cost
- Annual Hours of Operation
- Lifetime (all systems must be capitalized twice in the analysis period but not to exceed 40 years.)

Refer to Appendix E for an example of a life cycle cost analysis. Exclude maintenance costs in all retrofit life cycle cost analyses.

Note: For Air Force LED applications that do not have built-in failure detection in the luminaire, labor costs to measure light levels (baseline and 70% output – before the end of the warranty) must be considered in the analysis.

4-2 LIGHTING ZONES.

Lighting zones reflect the base (or ambient) light levels desired for an area. Adopt the lowest possible lighting zone. Lighting zones are best implemented as an overlay to the established zoning especially on installations where a variety of zone districts exist within a defined area or along an arterial street. Where zone districts are cohesive, it may be possible to assign lighting zones to established land use zoning. It is recommended that the lighting zone includes churches, schools, parks, and other uses embedded within residential communities or to any land assigned to a lower zone.

For DoD installations, it is important to consider all activities of an area's land use. Lighting zones must consider the surrounding areas as well. For example, adjacent lighting zones must not hinder nighttime operations. Additionally, in Outside Continental of United States (OCONUS) areas, it is important that the installation does not stand out as an exceptionally bright area compared to the adjacent development. Table 4-1 and Figure 4-1 show examples of how lighting zones may be applied to DoD installations.

Table 4-1. Lighting Zones and DoD Applications.

MLO Lighting Zones	Title	DoD Installation/Application	 INCREASING NIGHT TIME ACTIVITY
LZ0	No Ambient Lighting	Training areas Night vision training areas, endangered waterfront areas and other areas where there is expected no nighttime activity.	
LZ1	Low Ambient Lighting	Personnel Support Districts Unaccompanied quarters, single and multi-family residential, campgrounds, administration, and other non-nighttime use areas, golf course, exercise fields and paths Airfield (Nearby facilities may be higher zone)	
LZ2	Moderate Ambient Lighting	Waterfront or Airfield Facilities Administrative areas, common areas, service areas, parking. Training Facilities Academic instruction, educational services, applied instruction, reserve training, operational simulators Administrative Facilities Offices, conference centers, command centers, parking Personnel Support Districts Officer clubs, lodge, food service, fire and security, ITT, medical and dental clinics, family services, schools, childcare facilities, youth programs, religious facilities, banks, exchange, commissary, libraries, morale, welfare and recreation, hobby shops, theaters, gyms indoor sport facilities, outdoor pools, sports (tennis, basketball) courts, baseball and football fields Industrial Facilities Shipyards, ordinance handling/storage, manufacturing facilities, maintenance shops, depots	
LZ3	Moderately High Ambient Lighting	Waterfront Facilities Wharf and pier areas Airfield Facilities Aircraft maintenance and hangars, air operations and headquarters, line shacks, terminal facilities, training areas, utility service areas	
LZ4	High Ambient Lighting	No areas qualify for this lighting zone.	

Figure 4-1. Example Lighting Zones on a Sample Installation



4-3 LIGHTING CONTROLS.

Lighting control requirements must meet ASHRAE 90.1, ASHRAE 189.1, and this UFC. Refer to UFC 1-200-02 for publication year of ASHRAE. Refer to CHAPTER 5 (Exterior Applications) for control requirements. Provide commissioning per ASHRAE requirements. Refer to IES DG-29 for commission guidance.

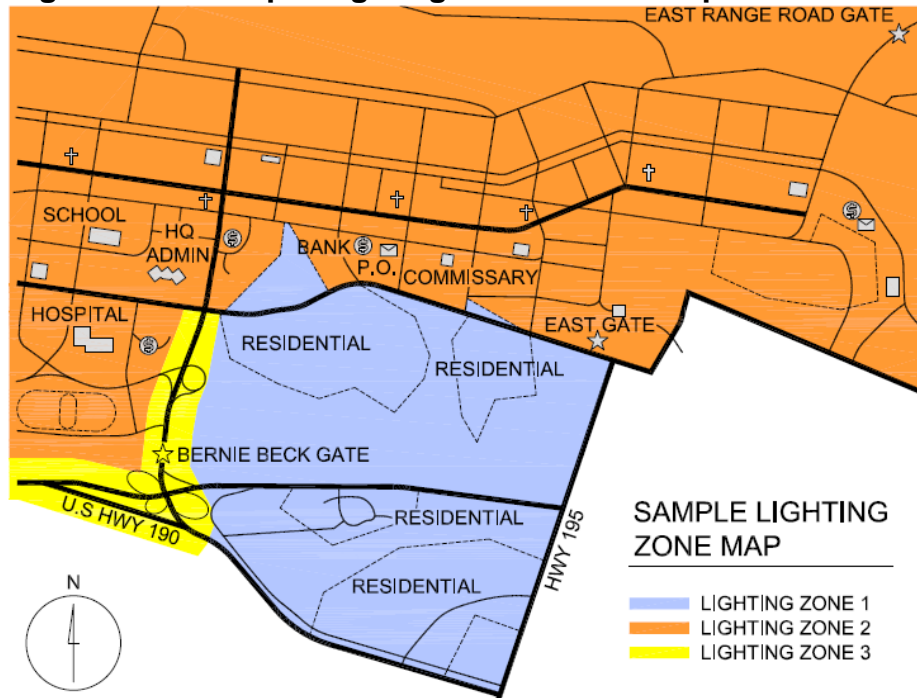
4-3.1 Control Strategies.

Designers must indicate in the contract documents the control strategy for each space in accordance with narrative descriptions in Table 4-2. Refer to CHAPTER 5 Exterior Applications for additional information.

Table 4-2. Exterior Control Strategies.

Control Strategy Name	Control Strategy Description
Manual On/Manual Off	The lights are manually turned on and manually turned off. This approach can only be used when other control strategies cannot be implemented due to operational requirements.
Photo sensor on/ photo sensor off	At sunset or shortly after, the lights automatically turn on. At sunrise or shortly before, the lights automatically turn off.
Photo sensor on/ timeclock off	At sunset or shortly after, the lights automatically turn on. At a preset time, the lights turn off.
Timeclock on/ timeclock off	At a preset time, the lights automatically turn on. At a preset time, the lights automatically turn off.
Timeclock on/ vacancy adjust/ timeclock off	At a preset time, the lights automatically turn on. Upon sensing vacancy, the lights switch or dim to 50% of full light output. At a preset time, the lights automatically turn off
Timeclock on/ conflict level adjust/ timeclock off	At a preset time, the lights automatically turn on. Upon sensing a reduction in conflict level (pedestrian or vehicular), the lights switch or dim to 50% of full light output.
User interface on/ conflict level adjust/user interface off	Through a web browser that is wirelessly connected to the lighting system, a user can turn the lights on, adjust brightness level, and turn off.

4-3.2 Network Certification.

Network control systems (including systems separate from an energy management control system) must be planned, designed, acquired, executed, and maintained in accordance with DoD Instruction 8500.01 and DoD Instruction 8510.01, and as required by individual Service Implementation Policy. Coordinate wireless networks with base spectrum manager prior to specification in case of restrictions for wireless usage within the installation.

Note: For AF projects, refer to ETL 11-1 for additional requirements.

4-4 EQUIPMENT.

4-4.1 Multi-Pin Receptacle.

Streetlights must be capable of being upgraded to a wireless control system. Streetlights must be installed with an ANSI C136.41 multi-pin receptacle. This five to seven pin receptacle will accept a standard three-pin photocell until the system is upgraded.

4-4.2 Light Source Technology.

Use a CCT of no greater than 4100K as stated on the manufacturer's cutsheet to reduce skyglow in exterior applications.^{2&3} Use a color rendering index (CRI) of no less than 70 for exterior applications.

Note, per ANSI C78.377-2011 standard, nominal CCT of 4000K is 3985K +/-275K for SSL products

4-4.2.1 Solid State Lighting (SSL).

- Use monochromatic amber LEDs in place of Low Pressure Sodium (LPS) for sensitive environments such as wildlife habitat, observations, wildlife nesting, or to meet dark sky requirements (observatories). Incorporate Fish and Wildlife, State, and local governing authority recommendations for lighting systems design and installation.
- IES LM-79, LM-80 testing reports must be supplied from manufacturer and include all relevant information.
- LED luminaires require integral metal oxide varistors (MOV) type surge protection device (SPD).
- LED luminaires require a 10-year warranty.

4-4.2.2 Induction (Electrodless Fluorescent).

- No restrictions.

4-4.2.3 Metal Halide.

- Use coated light sources.

4-4.2.4 Mercury Vapor.

- Do not use mercury vapor light sources.

4-4.2.5 High and Low Pressure Sodium (LPS).

- Do not use high pressure sodium (HPS) light sources for new exterior applications. Under special consideration HPS light sources may be used where existing conditions and continuity of source types make it necessary.

² IES TM-12-12. Lamp Spectral Effects at Mesopic Lighting Levels. The Illuminating Engineering Society of North America. New York, NY.

³ IES TM-18-08. Light and Human Health. The Illuminating Engineering Society of North America, New York, NY.

- Do not use LPS light sources except for unique applications such as in sea turtle nesting areas.

4-4.2.6 Linear Fluorescents.

- Do not mix linear fluorescent light source color temperatures within area to minimize maintenance and the chance of visual confusion.
- Do not use T12 light sources.
- Do not use in cold temperature environments (colder than 50 degrees Fahrenheit), except where alternatives such as SSL are unavailable.

4-4.2.7 U-Bent Fluorescent.

- Do not use u-bent fluorescent light sources.

4-4.2.8 Compact Fluorescent Light (CFL).

- Do not use CFL sources less than 13 watts.
- Use electronic dimming ballasts when dimming is required.
- Do not mix CFL source color temperatures within an area to minimize maintenance and the chance of visual confusion.
- Do not use in cold temperature environments (colder than 50 degrees Fahrenheit), except where alternatives such as SSL are unavailable.

4-4.2.9 Light Emitting Plasma (LEP).

LEP is currently available for high lumen output and high mast applications. There are minimal CCT offerings and those that are available exceed the consideration for a CCT of no greater than 4100K. LEP is not currently a suitable light source for exterior applications. When luminaires are available from three manufacturers at warmer color temperatures, this technology may be a viable option to consider.

4-4.3 Ballasts, Drivers, Generators, and Power Supplies.

4-4.3.1 Solid State Lighting Drivers.

- Total current harmonic distortion less than or equal to 20%.
- Power factor (PF) greater than or equal to 0.9.
- For current and future dimming requirements (i.e. smart grid, curfew, adaptive), use dimmable or bi-level drivers compatible with standard dimming control circuit of 0-10V. Other dimming protocols must comply with Network Certification requirements.

4-4.3.2 Linear Fluorescent Ballasts.

- Provide dimmable or bi-level ballasts.
- Use programmed start ballasts with end of life protection.
- NEMA premium electronic ballasts must be specified where applicable.
- Do not use instant start ballasts.

4-4.3.3 Compact Fluorescent Ballasts.

- Provide programmed start ballasts for compact fluorescent light sources that include end of life protection.

4-4.3.4 High Intensity Discharge Ballasts.

- Power factor (PF) greater than or equal to 0.9.
- Provide electronic ballasts for all available wattages.

4-4.4 Surge Protection Device (SPD).

Provide MOV type SPDs at panelboards for all circuits feeding exterior lighting systems.

4-4.5 Over Current Protection Device.

Provide in-line fuse in pole base or splice box for street and area lights. Monitoring Equipment.

4-5 ELECTRICAL ENERGY MONITORING.

For new construction buildings greater than 25,000 SF (2,322 m²), terminate exterior lighting branch circuits in dedicated lighting panelboards.

Provide measurement devices to separately monitor the electrical energy use for exterior lighting.

4-6 SOLAR LIGHTS.

Solar lights are not permitted for use for security lighting or safety applications. Solar lights are permitted for use when:

- Electric utility services do not exist in the desired location of lighting.
- Centralized solar panels can be deployed to provide power to the lights.
- Sufficient battery capacity is provided to meet illumination requirements.

- Used with curfew controls to maximize battery life.

4-7 REPLACING EXISTING SYSTEMS.

LED components and luminaires are being marketed for a wide range of applications. LED must not be considered as a “one size fits all” solution. Designers must first consider a redesign and then a luminaire replacement.

4-7.1 Redesign.

Redesign includes new luminaires, circuits, and controls designed to meet current lighting criteria. A new design must ensure reduced energy consumption, reduced maintenance, and lighting quality is improved at the lowest life cycle cost. When existing pole locations are to be used as part of the redesign, the designer must evaluate the need for pole modification to account for possible resonance issues due to wind when reducing the weight and EPA of the luminaire replacement.

Lighting redesign is required when a renovation involves changing lighting technologies such as fluorescent to LED and when renovation involves changing lighting with more efficient lighting within the same technology. Redesign lighting systems when existing:

- Illuminance levels are too low or too high
- Lighting produces glare
- Luminaire layout produces uneven illumination
- Luminaires are in poor condition
- Hazards are present

4-7.2 One for One Luminaire Replacement.

A luminaire replacement consists of the entire luminaire being replaced, including the housing. A luminaire replacement may be considered when the lighting design is sufficient, but more efficient luminaires are available. In instances where the existing luminaire was operating under dimming control, the control must be upgraded to be compatible with the operating characteristics of the replacement luminaire.

Luminaire replacement is only acceptable when the resulting illuminance levels, glare, and distribution meet the current criteria. The designer must evaluate the need for pole modification to account for possible resonance issues due to wind when reducing the weight and EPA of the luminaire replacement.

4-7.3 Light Source Retrofit.

A light source retrofit is the replacement of the light source within the luminaire housing or the lighting module that has been designed to be installed in existing luminaire enclosures.

Do not use LED retrofit light sources or LED lighting modules that have been designed and constructed to be installed in existing HID, mercury vapor, or linear fluorescent luminaire enclosures. LED retrofits are only approved for replacement of CFL or incandescent sources (A lamp replacements) with Edison bases.

4-8 SITE DESIGN COORDINATION.

Coordinate the design, luminaire selection, and placement with the location of trees, shrubs, and other site furnishing.

4-9 AIRFIELDS.

UFC 3-260-01, *Airfield and Heliport Planning and Design*, limits light emissions – either directly or indirectly (reflected) – that may interfere with pilot vision in runway clear zones. Exterior lighting must meet all FAA and airfield operational regulations. These regulations restrict the height, location, and technology of lighting located near airfields. Certain light sources may also interfere with night vision technologies. Obtain approval of lighting from installation's airfield safety office.

Use fully shielded or U0 rated luminaires to reduce glare which may affect airfield operations. Do not exceed a glare rating of G2. Refer to UFC 3-535-01 *Visual Air Navigation Facilities* for additional information.

Note: For AF projects:

- Refer to ETL 11-29 for additional requirements.
- Use of LED luminaires for airfield ramp, apron, alert, airfield security lighting requires appropriate base level organization coordination.

This Page Intentionally Left Blank

CHAPTER 5 EXTERIOR APPLICATIONS.

5-1 INTRODUCTION.

This chapter identifies typical exterior facility applications. Each application details a conceptual lighting design example. Designs must meet the lighting performance and controls requirements defined in the application details.

5-2 CALCULATIONS OF LIGHTING FOR EXTERIOR AREAS.

Computer-generated photometric plans for each area are required to verify proposed luminaires and locations meet the required performance criteria of the design using \1\ the applicable light loss factor (LLF)./1/ Photometric plan submittals must include:

- Horizontal illuminance (or luminance for roadways) measurements at pavement, taken at a maximum of every 10 feet (3 m).
- Minimum and maximum illuminance (or luminance for roadways) levels.
- Average maintained illuminance (or luminance for roadways) level.
- Average to minimum and maximum to minimum ratios for horizontal illuminance (or luminance for roadways).
- Lighting power density (Watts per square foot or per square meter).
- \1\ LLF /1/

5-3 PARKING FACILITIES.

5-3.1 Parking Lots.

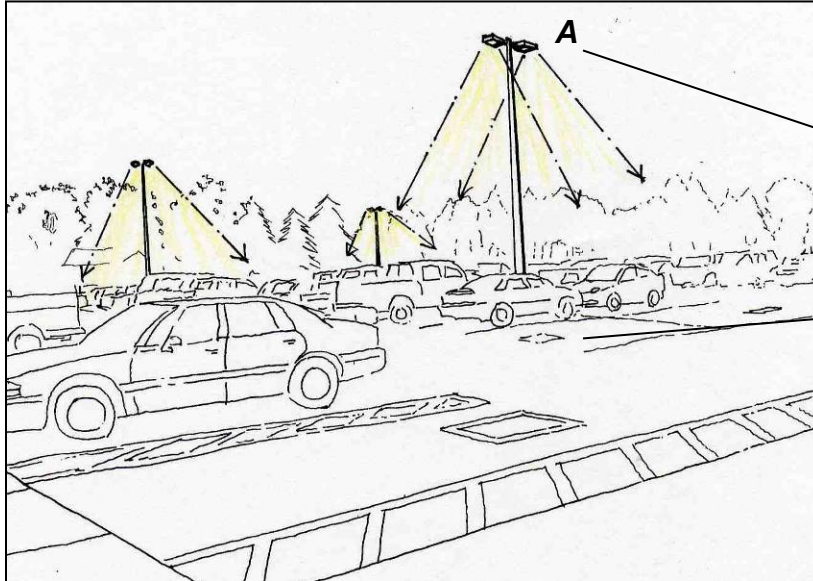

Fully shielded or U0 rated luminaires control glare and reduce light pollution and trespass.

Spacing of luminaires provides uniform horizontal illuminance in parking areas.

EQUIPMENT REQUIREMENTS:

	LUMINAIRE	LIGHT SOURCE	CONTROLS per ASHRAE (refer to General Building Requirements for clarification)
A	<i>Pole mounted luminaire.</i>	<i>LED, induction, or metal halide.</i>	<i>On at dusk Automatically reduce lighting power by a minimum of 30% from 12 midnight or within one hour of normal closing, whichever is later, until 6 am or normal opening, whichever is earlier; and / or during any period when no activity has been detected for a time of no longer than 15 minutes. Automatically turn off when sufficient daylight is available.</i>

PERFORMANCE REQUIREMENTS:

Target Criteria	
<i>Horizontal Illuminance (Average ±10%)</i>	<i>0.2 (2 lux) at grade (basic) 0.5 fc (5 lux) at grade (enhanced security)</i>
<i>Vertical Illuminance (Average ±10%)</i>	<i>0.1 (1 lux) at 5'-0" (1.5m) AFF (basic) 0.25 fc (2.5 lux) at 5'-0" (1.5m) AFF (enhanced security)</i>
<i>Horizontal Illuminance Uniformity</i>	<i>20:1 Maximum to Minimum (basic) 15:1 Maximum to Minimum (enhanced security)</i>

Criteria apply to all lighting zones.

CRITICAL DESIGN ISSUES:

- Provide U0 or U1 rated luminaires with low lumen output to minimize glare and light pollution.
- Provide Type V distributions for luminaires within the parking areas. Use Type III and IV distributions along the perimeters to minimize light trespass on a neighboring property or building unless luminaires are intended to illuminate adjacent property or building.

5-4 BUILDING LIGHTING.

5-4.1 Entrances.

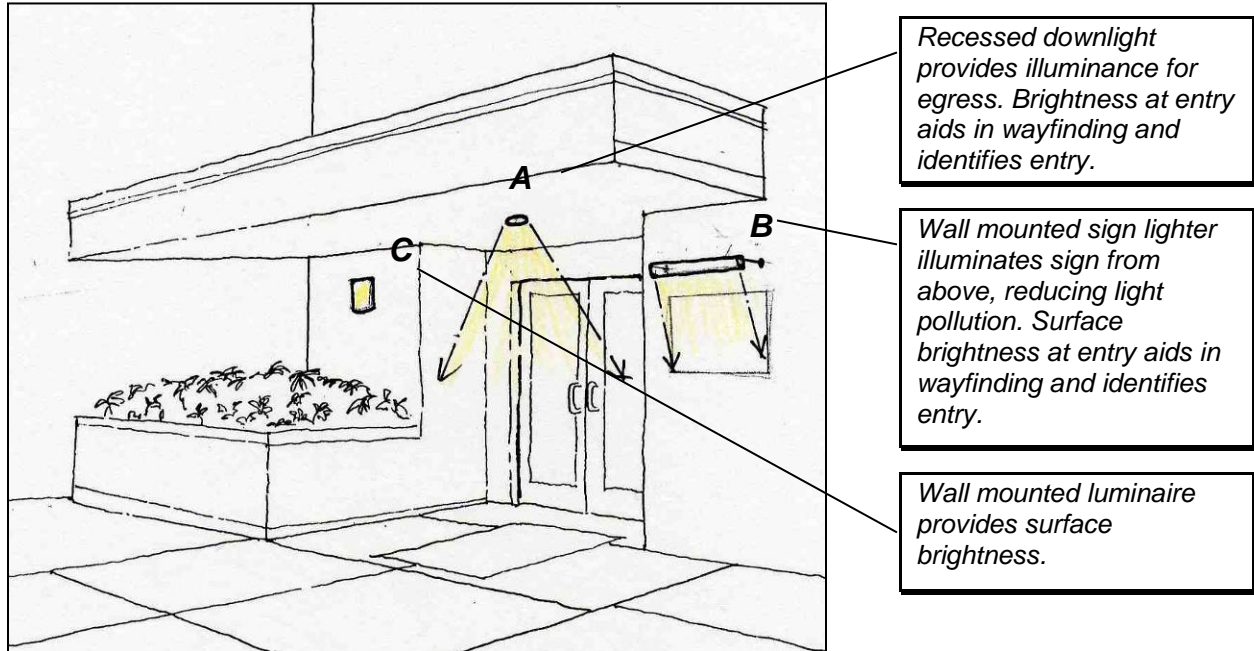

Recessed downlight provides illuminance for egress. Brightness at entry aids in wayfinding and identifies entry.

Wall mounted sign lighter illuminates sign from above, reducing light pollution. Surface brightness at entry aids in wayfinding and identifies entry.

Wall mounted luminaire provides surface brightness.

EQUIPMENT REQUIREMENTS:

	LUMINAIRE	LIGHT SOURCE	CONTROLS per ASHRAE (refer to General Building Requirements for clarification)
A	<i>Recessed downlight.</i>	<i>LED (except for high ambient temperature applications) or fluorescent.</i>	<i>On at dusk Automatically reduce lighting power by a minimum of 30% from 12 midnight or within one hour of normal closing, whichever is later, until 6am or normal opening, whichever is earlier; and/or during any period when no activity has been detected for a time of no longer than 15 minutes. Automatically turn off when sufficient daylight is available.</i>
B	<i>Wall mounted linear wall washer.</i>	<i>LED or fluorescent.</i>	
C	<i>Wall mounted Luminaire.</i>	<i>LED or fluorescent.</i>	

PERFORMANCE REQUIREMENTS

Illuminance Requirements for Building Entries with Canopies

	LZ0 No ambient	LZ1 Low ambient	LZ2 Moderate ambient	LZ3 Moderately high ambient	LZ4 High ambient
Average Horizontal (fc)	<i>0.2-1 fc</i> <i>2-10 lux</i>	<i>0.4-1.5 fc</i> <i>4-15 lux</i>	<i>0.6-2 fc</i> <i>6-20 lux</i>	<i>0.8-3 fc</i> <i>8-30 lux</i>	<i>1-4 fc</i> <i>10-40 lux</i>
Average Vertical (fc)	<i>0-0.6 fc</i> <i>0-6 lux</i>	<i>0.1-0.8 fc</i> <i>1-8 lux</i>	<i>0.2-1 fc</i> <i>2-10 lux</i>	<i>0.4-1.5 fc</i> <i>4-15 lux</i>	<i>0.6-2 fc</i> <i>6-20 lux</i>

Illuminance Requirements for Building Entries without Canopies

	LZ0 No ambient	LZ1 Low ambient	LZ2 Moderate ambient	LZ3 Moderately high ambient	LZ4 High ambient
Average Horizontal (fc)	<i>1 fc</i> <i>10 lux</i>	<i>1 fc</i> <i>10 lux</i>	<i>1 fc</i> <i>10 lux</i>	<i>1 fc</i> <i>10 lux</i>	<i>1 fc</i> <i>10 lux</i>
Average Vertical (fc)	<i>0.1-0.6 fc</i> <i>1-6 lux</i>	<i>0.2-0.8 fc</i> <i>2-8 lux</i>	<i>0.4-1 fc</i> <i>4-10 lux</i>	<i>0.6-1.5 fc</i> <i>6-15 lux</i>	<i>0.8-2 fc</i> <i>8-20 lux</i>

CRITICAL DESIGN ISSUES:

- Comply with NFPA 101 lighting requirements for each exit discharge.
- Select luminaires to match the aesthetic character of the building and contribute to a welcome designation to the building entry.
- All luminaires must use shielded optics and/or low wattage light sources to minimize glare and light pollution.
- Uniformity must be 2:1 average to minimum horizontal and 4:1 average to minimum vertical to illuminate walkways at building entrance.
- Select and locate lighting to eliminate shadows near entries and provide wayfinding.

5-4.2 Exits.

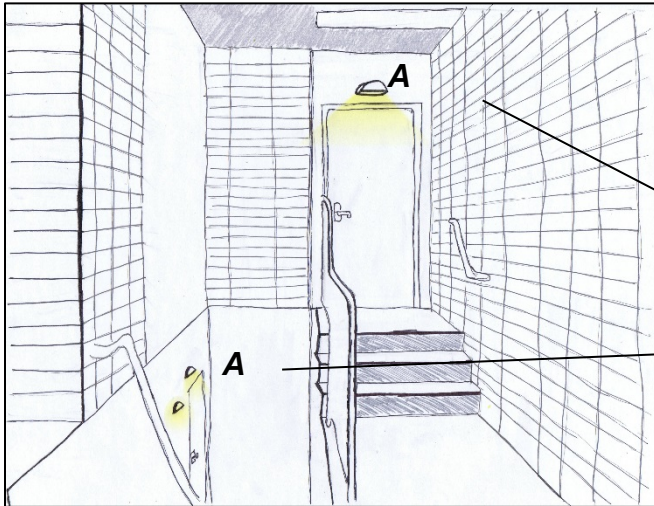

Wall mounted luminaire provides surface brightness.

EQUIPMENT REQUIREMENTS:

	LUMINAIRE	LIGHT SOURCE	CONTROLS per ASHRAE (refer to General Building Requirements for clarification)
A	Wall mounted fully shielded, U0 or U1 rated..	LED or fluorescent.	On at dusk Automatically reduce lighting power by a minimum of 30% from 12 midnight or within one hour of normal closing, whichever is later, until 6am or normal opening, whichever is earlier; and / or during any period when no activity has been detected for a time of no longer than 15 minutes. Automatically turn off when sufficient daylight is available.

PERFORMANCE REQUIREMENTS

Illuminance Requirements for Building Exits with Canopies

	LZ0 No ambient	LZ1 Low ambient	LZ2 Moderate ambient	LZ3 Moderately high ambient	LZ4 High ambient
Average Horizontal (fc)	0.2-1 fc 2-10 lux	0.4-1.5 fc 4-15 lux	0.6-2 fc 6-20 lux	0.8-3 fc 8-30 lux	1-4 fc 10-40 lux
Average Vertical (fc)	0-0.6 fc 0-6 lux	0.1-0.8 fc 1-8 lux	0.2-1 fc 2-10 lux	0.4-1.5 fc 4-15 lux	0.6-2 fc 6-20 lux

Illuminance Requirements for Building Exits without Canopies

	LZ0 No ambient	LZ1 Low ambient	LZ2 Moderate ambient	LZ3 Moderately high ambient	LZ4 High ambient
Average Horizontal (fc)	1 fc 10 lux	1 fc 10 lux	1 fc 10 lux	1 fc 10 lux	1 fc 10 lux
Average Vertical (fc)	0.1-0.6 fc 1-6 lux	0.2-0.8 fc 2-8 lux	0.4-1 fc 4-10 lux	0.6-1.5 fc 6-15 lux	0.8-2 fc 8-20 lux

CRITICAL DESIGN ISSUES:

- Comply with NFPA 101 lighting requirements for each exit discharge.
- Select luminaires to match the aesthetic character of the building.
- All luminaires must use shielded optics and/or low wattage light sources to minimize glare and light pollution.

5-4.3 Housing Areas.



The use of fully shielded or U0 rated wall mounted luminaires, area lights, and downlighting on the façade (rather than uplighting) minimizes light pollution.

Pole mounted pedestrian poles light walkways.

EQUIPMENT REQUIREMENTS:

	LUMINAIRE	LIGHT SOURCE	CONTROLS per ASHRAE (refer to General Building Requirements for clarification)
A	Wall mounted, U0 or U1 rated.	LED or fluorescent.	Local control within the housing unit
B	Wall mounted, fully shielded, U0 or U1 rated.	LED or fluorescent.	On at dusk. Automatically reduce lighting power by a minimum of 30% during any period when no activity has been detected for a time of no longer than 15 minutes.
C	Pole mounted, U0 or U1 pedestrian luminaire.	LED, induction, high output compact fluorescent, or metal halide.	Automatically turn off when sufficient daylight is available.
C ALT	Bollard, (Typically, these luminaires provide poor facial lighting. Best used as indicators rather than for area or pedestrian lighting.)	LED, fluorescent or induction.	

PERFORMANCE REQUIREMENTS:

See requirements for Building Entries.

CRITICAL DESIGN ISSUES:

- Use U0 or U1 rated luminaires.
- All luminaires must use shielded optics and/or low wattage light sources to minimize glare and light pollution.
- Uniformity must be 2:1 average to minimum horizontal and 4:1 average to minimum vertical to illuminate walkways at building entrance.

5-5 PEDESTRIAN AREAS.

5-5.1 Walkways.

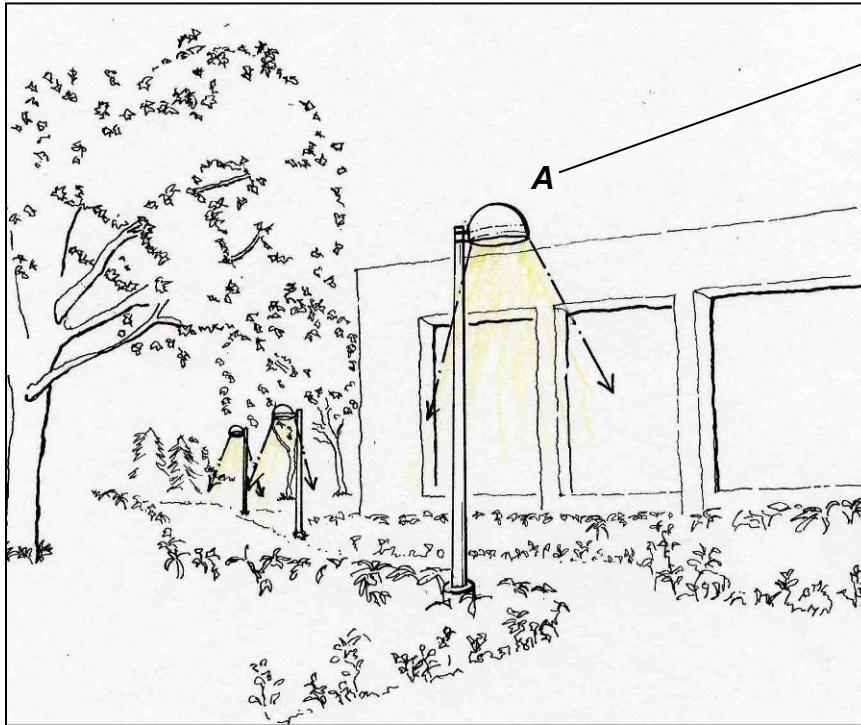

Low brightness luminaires reduce direct glare and provide adequate vertical illuminance while minimizing light pollution and trespass.

EQUIPMENT REQUIREMENTS

	LUMINAIRE	LIGHT SOURCE	CONTROLS per ASHRAE (refer to General Building Requirements for clarification)
A	<i>Pole mounted, U0 or U1 rated pedestrian scale luminaire.</i>	<i>LED, induction, or fluorescent.</i>	<i>On at dusk. Automatically reduce lighting power by a minimum of 30% during any period when no activity has been detected for a time of no longer than 15 minutes.</i>
A ALT	<i>Bollard, (Typically, these luminaires provide poor facial lighting. Best used as indicators rather than for area or pedestrian lighting.)</i>	<i>LED or fluorescent.</i>	<i>Automatically turn off when sufficient daylight is available.</i>

PERFORMANCE REQUIREMENTS:

	LZ0 No ambient	LZ1 Low ambient	LZ2 Moderate ambient	LZ3 Moderately high ambient	LZ4 High ambient
Average Horizontal (fc)	<i>0.1-0.2 fc (1-2 lux)</i>	<i>0.1-0.4 fc (1-4 lux)</i>	<i>0.2-0.6 fc (2-6 lux)</i>	<i>0.4-0.8 fc (4-8 lux)</i>	<i>0.6-1 fc (6-10 lux)</i>
Average Vertical (fc)	<i>0.0-0.1 fc (0-1 lux)</i>	<i>0.1-0.2 fc (1-2 lux)</i>	<i>0.1-0.2 fc (1-2 lux)</i>	<i>0.2-0.4 fc (2-4 lux)</i>	<i>0.2-0.6 fc (2-6 lux)</i>

CRITICAL DESIGN ISSUES:

- Match aesthetics of decorative poles to that of adjacent buildings.
- All luminaires must be U0 or U1 and must use shielded optics, such as a lens or louver, and low wattage light sources to minimize glare and light pollution.
- Uniformity must be 4:1 average to minimum horizontal and 10:1 average to minimum vertical.
- Place poles at potential conflict locations, such as intersections.

5-5.2 Plazas.

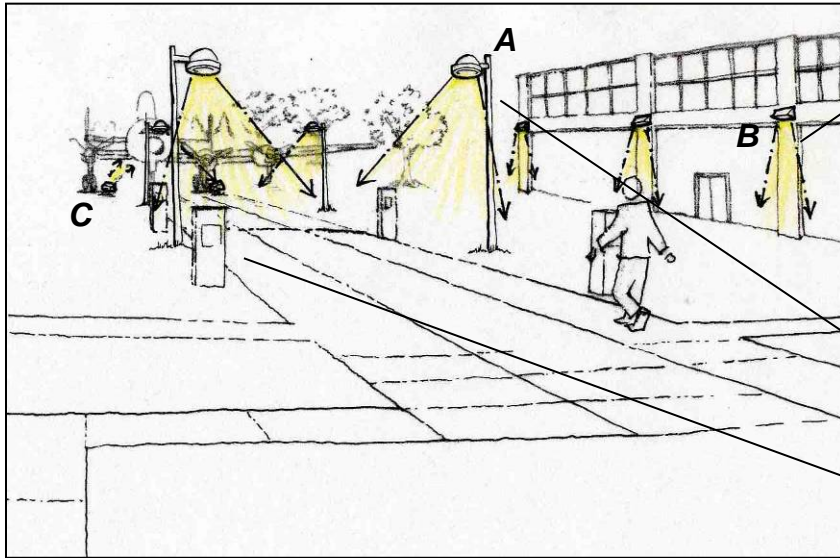

Building lighting illuminates the perimeter of the plaza and helps to define the exterior "space". This perimeter lighting also provides a sense of security.

Low brightness pedestrian poles reduce direct glare and provide adequate vertical illuminance.

Feature accent lighting highlights focal points of the plaza.

EQUIPMENT REQUIREMENTS:

	LUMINAIRE	LIGHT SOURCE	CONTROLS per ASHRAE (refer to General Building Requirements for clarification)
A	<i>Pole mounted, U0 or U1 rated, pedestrian scale luminaire.</i>	<i>LED, induction, high output fluorescent or coated metal halide.</i>	<i>On at dusk Automatically reduce lighting power by a minimum of 30% from 12 midnight or within one hour of normal closing, whichever is later, until 6 am or normal opening, whichever is earlier. Automatically turn off when sufficient daylight is available.</i>
A ALT	<i>Bollard, (Typically, these luminaires provide poor facial lighting. Best used as indicators rather than for area or pedestrian lighting.)</i>	<i>LED, compact fluorescent, or metal halide.</i>	
B	<i>Building mounted U0 or U1 rated downlight / wallwasher.</i>	<i>LED or compact fluorescent.</i>	
C	<i>Accent light.</i>	<i>LED, compact fluorescent, or metal halide.</i>	<i>On at dusk Automatically turn off from 12 midnight or at normal closing, whichever is later, until 6 am or normal opening, whichever is earlier. Automatically turn off when sufficient daylight is available.</i>

PERFORMANCE REQUIREMENTS:

	LZ0 No ambient	LZ1 Low ambient	LZ2 Moderate ambient	LZ3 Moderately high ambient	LZ4 High ambient
Average Horizontal (fc)	<i>0.0-0.1 fc</i> <i>(0-1 lux)</i>	<i>0.1-0.2 fc</i> <i>(1-2 lux)</i>	<i>0.1-0.4 fc</i> <i>(1-4 lux)</i>	<i>0.2-0.6 fc</i> <i>(2-6 lux)</i>	<i>0.4-0.8 fc</i> <i>(4-8 lux)</i>
Average Vertical (fc)	<i>0 fc</i> <i>(0 lux)</i>	<i>0.0-0.1 fc</i> <i>(0-1 lux)</i>	<i>0.0-0.2 fc</i> <i>(0-2 lux)</i>	<i>0.1-0.2 fc</i> <i>(1-2 lux)</i>	<i>0.2-0.4 fc</i> <i>(2-4 lux)</i>

CRITICAL DESIGN ISSUES:

- Use U0 or U1 rated luminaires.
- Uniformity must be 4:1 average to minimum horizontal and 10:1 average to minimum vertical.

5-6 VEHICLE TRAFFIC AREAS.

5-6.1 Roadways and Streets.



Fully shielded or U0 rated luminaires control glare and reduce light pollution and trespass.

Spacing luminaires 4-5 times the mounting height provides uniform horizontal illuminance.

EQUIPMENT REQUIREMENTS:

	LUMINAIRE	LIGHT SOURCE	CONTROLS per ASHRAE (refer to General Building Requirements for clarification)
A	Pole mounted fully shielded or U0 roadway luminaire.	LED, induction, or metal halide.	On at dusk. Automatically reduce lighting power by a minimum of 30% during any period when no activity has been detected for a time of no longer than 15 minutes. Automatically turn off when sufficient daylight is available.

PERFORMANCE REQUIREMENTS:

Target Criteria	
Horizontal Illuminance (Average ±10%)	IES RP-8, Roadway Lighting
Vertical Illuminance (Average ±10%)	

Criteria apply to all lighting zones.

CRITICAL DESIGN ISSUES:

- Use fully shielded or U0 luminaires to minimize glare and reduce light pollution.
- Paint luminaires and poles to match installation standard.

5-6.2 Driveways.

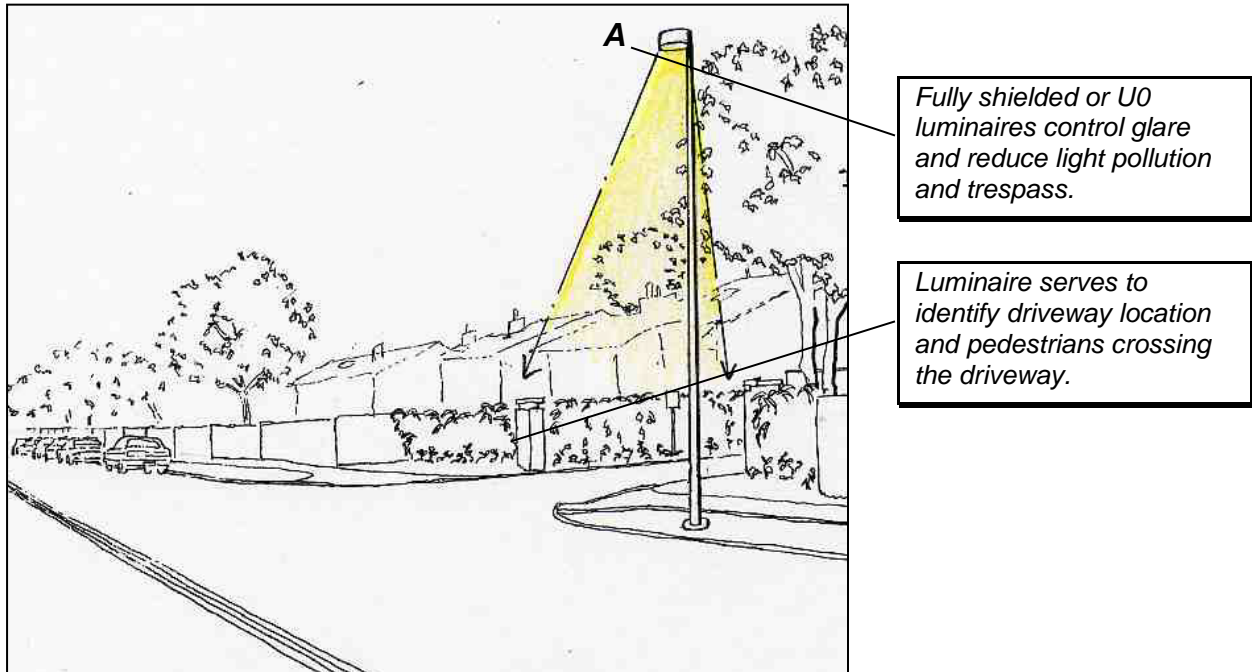

EQUIPMENT REQUIREMENTS:

	LUMINAIRE	LIGHT SOURCE	CONTROLS per ASHRAE (refer to General Building Requirements for clarification)
A	<i>Pole mounted fully shielded or U0 roadway luminaire.</i>	<i>LED, induction, or metal halide.</i>	<i>On at dusk. Automatically reduce lighting power by a minimum of 30% during any period when no activity has been detected for a time of no longer than 15 minutes. Automatically turn off when sufficient daylight is available.</i>

PERFORMANCE REQUIREMENTS:

Install one pole mounted, fully shielded roadway luminaire at the entrance to the driveway. Criteria apply to all lighting zones.

CRITICAL DESIGN ISSUES:

- Use fully shielded or U0 luminaires to minimize glare and reduce light pollution.

5-7 MARINAS.

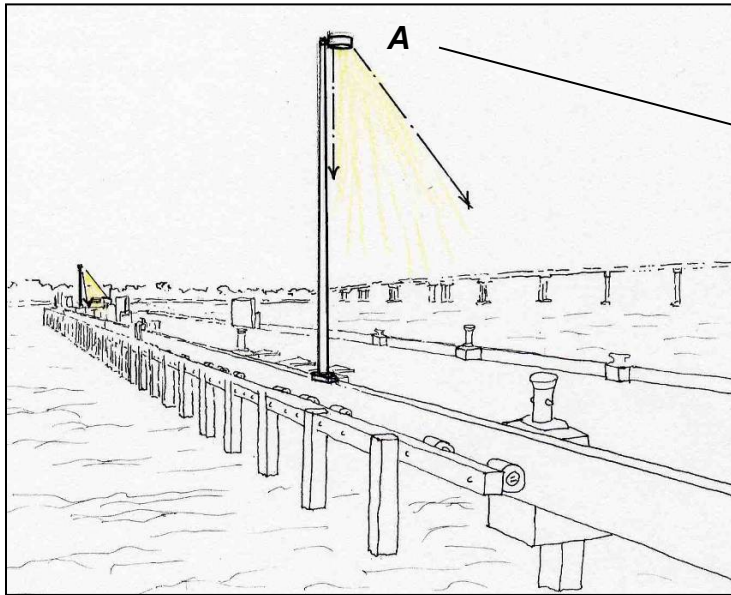

Fully shielded or U0 luminaires control glare and reduce light pollution and trespass.

EQUIPMENT REQUIREMENTS:

	LUMINAIRE	LIGHT SOURCE	CONTROLS per ASHRAE (refer to General Building Requirements for clarification)
A	<i>Pole mounted.</i>	<i>LED, induction, or coated metal halide. Use low pressure sodium light sources or approved monochromatic LEDs for sensitive environments such as wildlife habitat or nesting areas.</i>	<i>On at dusk. Automatically reduce lighting power by a minimum of 30% during any period when no activity has been detected for a time of no longer than 15 minutes. Automatically turn off when sufficient daylight is available.</i>

PERFORMANCE REQUIREMENTS:

Target Criteria	
<i>Horizontal Illuminance (Average ±10%)</i>	<i>0.5 fc (5 lux)</i>

Criteria apply to all lighting zones.

CRITICAL DESIGN ISSUES:

- Use fully shielded or U0 luminaires to minimize glare and to reduce light pollution.

- Monochromatic LEDs may be used in place of LPS for sensitive environments such as wildlife habitat, observatories, wildlife nesting, or to meet Dark Sky requirements.

5-8 EXTERIOR RECREATIONAL AREAS.

5-8.1 Baseball and Softball Fields.

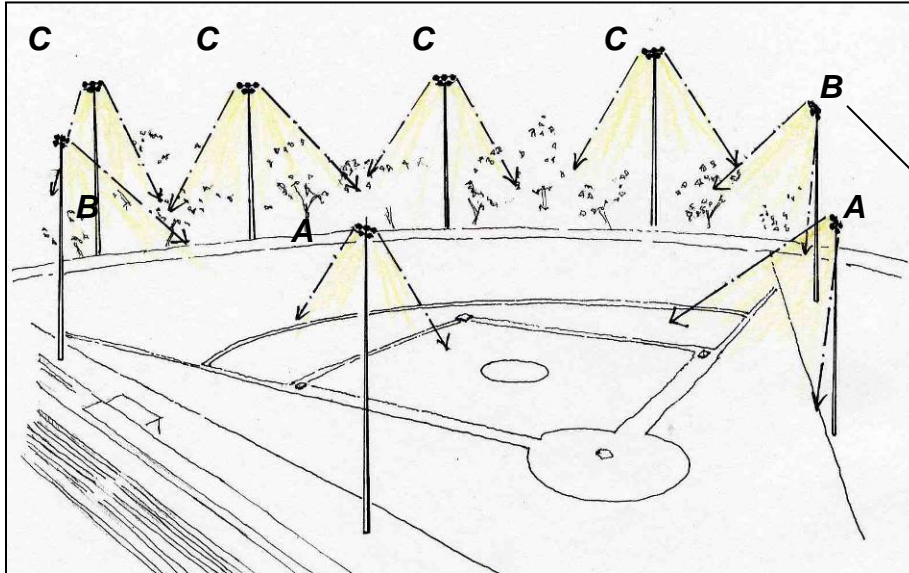

Luminaire locations provide vertical illuminance on the field while minimizing glare from critical viewing angles.

EQUIPMENT REQUIREMENTS:

	LUMINAIRE	LIGHT SOURCE	CONTROLS per ASHRAE (refer to General Building Requirements for clarification)
A	<i>Pole mounted modular rack of adjustable floodlights. Distribution types 2, 3, and 4 with internal and external shielding.</i>	<i>LED or Metal halide.</i>	<i>Manual on. All luminaires on when field is in use.</i>
B	<i>Pole mounted modular rack of adjustable floodlights. Distribution types 2, 3, 4, and 5 with internal and external shielding.</i>	<i>LED or Metal halide.</i>	<i>Automatically reduce lighting power by a minimum of 30% from 12 midnight until 6 am; and / or during any period when no activity has been detected for a time of no longer than 15 minutes.</i>
C	<i>Pole mounted modular rack of adjustable floodlights with internal and external shielding.</i>	<i>LED or Metal halide.</i>	<i>Automatically turn off when sufficient daylight is available. Manual off.</i>

PERFORMANCE REQUIREMENTS:

Target Criteria (Recreational)	Infield	Outfield
<i>Horizontal Illuminance (Average ±10%)</i>	<i>30 fc (300 lux)</i>	<i>20 fc (200 lux)</i>
<i>Vertical Illuminance (Average ±10%)</i>	<i>10 fc (100 lux)</i>	<i>5 fc (50 lux)</i>
<i>Uniformity (Maximum to Minimum)</i>	<i>2.5:1</i>	<i>3:1</i>

For other classes of play, see IES RP-6. Criteria apply to all lighting zones.

CRITICAL DESIGN ISSUES:

- Locate lighting poles outside of critical glare zones.
- Refer to *IES RP-6-01 Sports and Recreational Area Lighting*.
- Provide uniform illuminance on the field.
- Coordinate aiming of luminaires.

5-8.2 Tennis Courts.

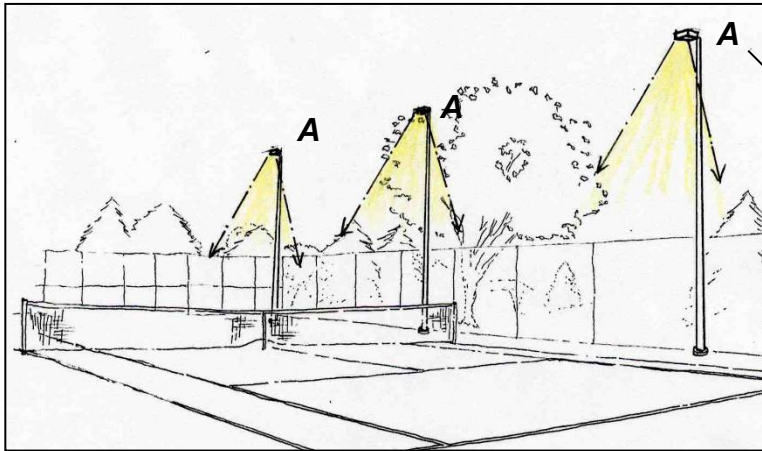

Pole mounted area lights provide minimum glare and uniform illuminance on the court.

EQUIPMENT REQUIREMENTS:

	LUMINAIRE	LIGHT SOURCE	CONTROLS per ASHRAE (refer to General Building Requirements for clarification)
A	<i>Pole mounted, fully shielded U0 area luminaire.</i>	<i>LED, induction, or coated metal halide.</i>	<i>Manual on. All luminaires on when courts in use. Automatically reduce lighting power by a minimum of 30% from 12 midnight until 6 am; and / or during any period when no activity has been detected for a time of no longer than 15 minutes. Automatically turn off when sufficient daylight is available. Manual off.</i>

PERFORMANCE REQUIREMENTS:

Target Criteria	Recreational
<i>Horizontal Illuminance (Average ±10%)</i>	<i>30 fc (300 lux)</i>
<i>Vertical Illuminance (Average ±10%)</i>	<i>10 fc (100 lux)</i>
<i>Uniformity (Maximum to Minimum)</i>	<i>2.5:1</i>

For other classes of play, see IES RP-6. Criteria apply to all lighting zones.

CRITICAL DESIGN ISSUES:

- Locate luminaires parallel to the direction of play.
- Specify electronic ballasts for metal halide luminaires.
- Provide uniform illuminance on the field.

5-8.3 Basketball Courts.

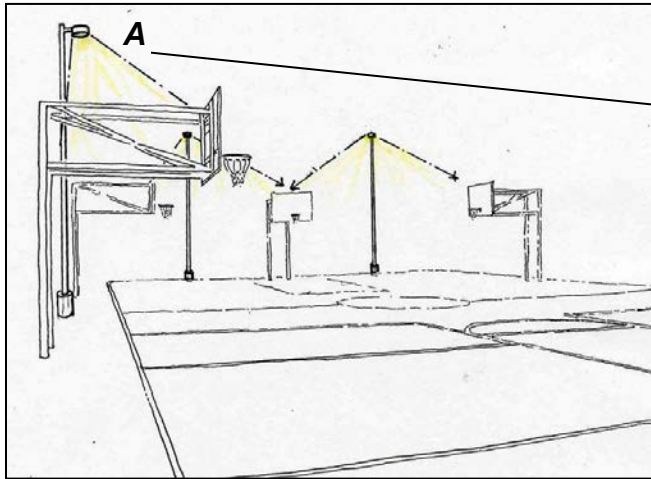

Pole mounted luminaires are spaced to provide uniform illuminance and minimize direct glare.

EQUIPMENT REQUIREMENTS:

	LUMINAIRE	LIGHT SOURCE	CONTROLS per ASHRAE (refer to General Building Requirements for clarification)
A	<i>Pole mounted, fully shielded or U0 area luminaire.</i>	<i>LED, induction, or coated metal halide.</i>	<i>Manual on.</i> <i>All luminaires on when courts in use.</i> <i>Automatically reduce lighting power by a minimum of 30% from 12 midnight until 6 am; and / or during any period when no activity has been detected for a time of no longer than 15 minutes.</i> <i>Automatically turn off when sufficient daylight is available.</i> <i>Manual off.</i>

PERFORMANCE REQUIREMENTS:

Target Criteria	Recreational
<i>Horizontal Illuminance (Average ±10%)</i>	<i>20 fc (200 lux)</i>
<i>Vertical Illuminance (Average ±10%)</i>	<i>5 fc (50 lux)</i>
<i>Uniformity (Maximum to Minimum)</i>	<i>4:1</i>

For other classes of play, see IES RP-6. Criteria apply to all lighting zones.

CRITICAL DESIGN ISSUES:

- Use fully shielded or U0 luminaires minimize glare.
- Provide uniform illuminance on the court.

5-8.4 Football Fields.

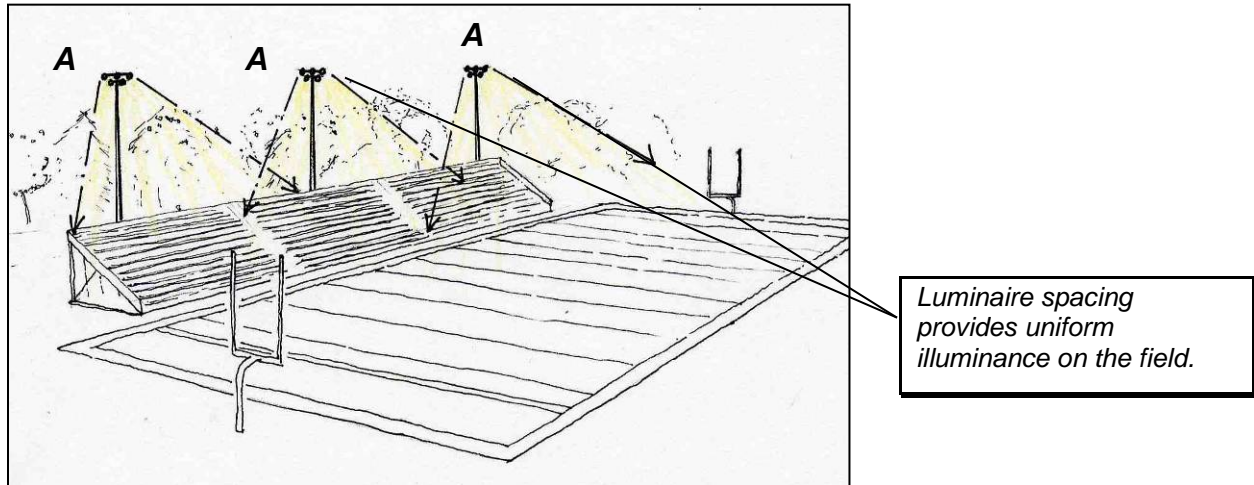

EQUIPMENT REQUIREMENTS:

	LUMINAIRE	LIGHT SOURCE	CONTROLS per ASHRAE (refer to General Building Requirements for clarification)
A	<i>Pole mounted modular rack of adjustable floodlights with internal and external shielding.</i>	<i>LED or metal halide.</i>	<i>Manual on. Automatically reduce lighting power by a minimum of 30% from 12 midnight or within one hour of normal closing, whichever is later, until 6 am or normal opening, whichever is earlier; and / or during any period when no activity has been detected for a time of no longer than 15 minutes. Automatically turn off when sufficient daylight is available. Manual off.</i>

PERFORMANCE REQUIREMENTS:

Target Criteria	Recreational
<i>Horizontal Illuminance (Average ±10%)</i>	<i>20 fc (200 lux)</i>
<i>Vertical Illuminance (Average ±10%)</i>	<i>5 fc (50 lux)</i>
<i>Uniformity (Maximum to Minimum)</i>	<i>4:1</i>

Note: For other classes of play, see IES RP-6. Criteria apply to all lighting zones.

CRITICAL DESIGN ISSUES:

- Locate lighting poles outside of critical glare zones.
- Refer to *IES RP-6 Sports and Recreational Area Lighting*.
- Provide uniform illuminance on the court.
- Coordinate aiming of luminaires.

5-8.5 Playgrounds.

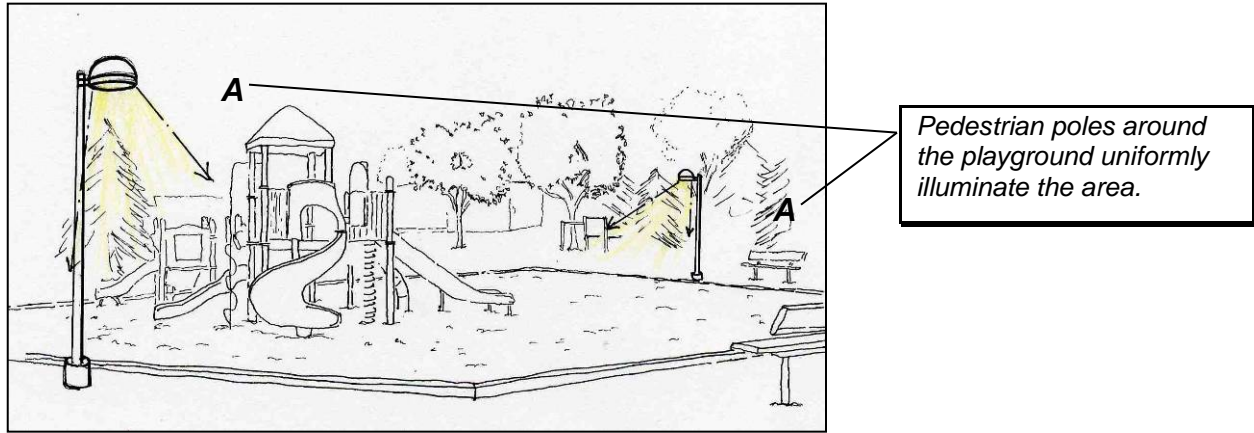

Pedestrian poles around the playground uniformly illuminate the area.

EQUIPMENT REQUIREMENTS:

	LUMINAIRE	LIGHT SOURCE	CONTROLS per ASHRAE (refer to General Building Requirements for clarification)
A	<i>Pole mounted, shielded U0 rated pedestrian scale luminaire.</i>	<i>LED, Induction, compact fluorescent, or coated metal halide.</i>	<i>On at dusk. Automatically turn off when sufficient daylight is available. Automatically reduce lighting power by a minimum of 30% or during any period when no activity has been detected for a time of no longer than 15 minutes.</i>

PERFORMANCE REQUIREMENTS:

Target Criteria	
<i>Horizontal Illuminance (Average ±10%)</i>	<i>5 fc (50 lux)</i>

Criteria apply to all lighting zones.

CRITICAL DESIGN ISSUES:

- Provide uniform illuminance on the area surrounding the playground.

5-9 OTHER AREAS.

5-9.1 Airfields (Hangar).

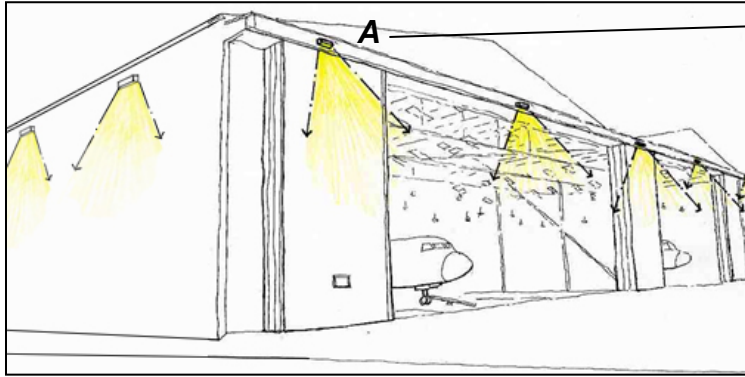

Wall mounted, fully shielded or U0 area luminaires illuminate both the hangar walls and the adjacent area. The fully shielded or U0 and G2 or less rating eliminates glare for approaching aircraft.

EQUIPMENT REQUIREMENTS:

	LUMINAIRE	LIGHT SOURCE	CONTROLS
A	Wall mounted, fully shielded or U0 area luminaire.	LED, induction, or metal halide.	Automatic OFF when sufficient daylight is available. Control separately from other building mounting lighting systems. Coordinate with airfield manager for control methodologies.

PERFORMANCE REQUIREMENTS:

Target Criteria	
Horizontal Illuminance (Average $\pm 10\%$)	1 fc (10 lux)

Criteria apply to all lighting zones.

CRITICAL DESIGN ISSUES:

- Provide U0 and G2 or less rated luminaires with low lumen output to minimize glare and light pollution.
- Coordinate lighting system with emergency backup power availability.

5-9.2 Airfields (Apron).

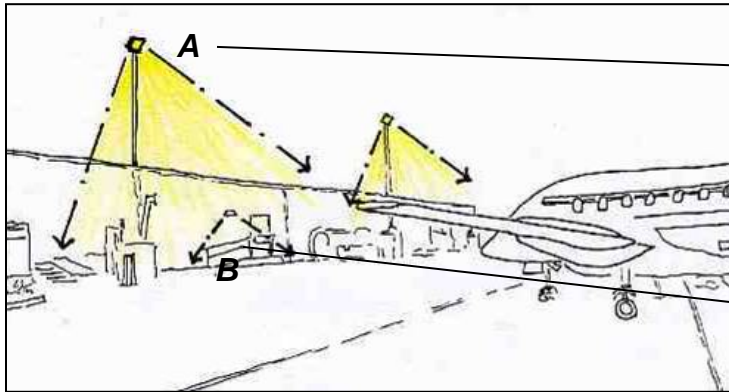

Provide internal louvers on standard adjustable apron luminaire to minimize glare for approaching pilots.

Wall mounted fully shielded or U0 area light located at doorways indicates entry and increases surface brightness.

EQUIPMENT REQUIREMENTS:

	LUMINAIRE	LIGHT SOURCE	CONTROLS
A	<i>Pole mounted adjustable apron luminaire with internal and external louvers.</i>	<i>Metal halide, LED, or induction.</i>	<i>Automatic OFF when sufficient daylight is available. Control separately from other building mounting lighting systems. Coordinate with airfield manager for control methodologies.</i>
B	<i>Wall mounted, fully shielded or U0 area light.</i>	<i>Metal halide, LED, or induction.</i>	<i>Automatic OFF when sufficient daylight is available. Control separately from other building mounting lighting systems. Coordinate with airfield manager for control methodologies.</i>

Criteria apply to all lighting zones.

PERFORMANCE REQUIREMENTS:

Target Criteria	
<i>Horizontal Illuminance (Average ±10%)</i>	<i>0.5 fc (5 lux)</i>

CHAPTER 6 SECURITY LIGHTING

6-1 INTRODUCTION

Exterior security lighting is an important issue for many facilities and not all of the specific criteria are addressed in this section. For lighting requirements this UFC supersedes MIL-HDBK-1013/1A, *Design Guidelines for Physical Security of Facilities*. Security lighting provides illumination during periods of darkness or in areas of low visibility to aid in the detection, assessment, and interdiction of aggressors by security forces. Security lighting is sometimes referred to as protective lighting.

6-2 PHYSICAL SECURITY.

The part of security concerned with physical measures designed to safeguard personnel; to prevent or delay unauthorized access to equipment, installations, material, and documents; and to safeguard them against espionage, sabotage, damage, and theft.

6-2.1 Physical Security System.

A system comprised of people, equipment, and operational procedures that control access to critical facilities or assets. Security lighting is one of the elements that comprise the equipment component of a physical security system. Figure 6-1 diagrams some of the components of a physical security system.

6-2.2 Security Lighting Overview.

6-2.2.1 Security Lighting Objectives.

Security lighting is one component of a larger physical security system. While the level of protection may vary, the lighting must supplement and facilitate all other measures taken to ensure the security of an asset. These other measures may take the form of security forces at an entry control point, sensitive inner areas, boundaries, or the use of closed circuit television (CCTV) cameras. In all cases, the lighting enhances visibility for either an individual or device and facilitates their performance.

In the simplest form, security lighting provides a clear view of an area for security personnel while reducing concealment opportunities for aggressors. A physical security system must be able to detect a threat, assess the threat, and then neutralize the threat.

6-2.3 Deterrent Value.

Security lighting at a site may deter lesser threats and aggressors. While a security lighting system will not deter sophisticated criminals or terrorists, it may influence unsophisticated criminals or vandals. The mere presence of light will increase the probability of detection or capture and may induce these types of aggressors to look for an easier target.

Similarly, the effective use of lighting can enhance the perception of security, which is important to the personnel who work within a secure area. This can be accomplished with glare reduction, lighted surfaces, proper uniformity, and adequate illuminance.

6-2.4 Defining Requirements.

Defining the requirements of a physical security system and its components involves an interdisciplinary planning team. The team considers all interests relating to a project to determine how security fits into the total project design. The specific membership of the planning team will be based on local considerations, but in general, the following functions are to be represented; facility user, antiterrorism officer, operations, security, logistics, engineering, life safety, and others as required. That team will use the process in UFC 4-020-01 to identify the design criteria, which includes the assets to be protected, the threats to those assets (the Design Basis Threat), and the levels of protection to be provided for the assets against the identified threats. In addition to those criteria elements, the team must also identify user constraints such as appearance, operational considerations, manpower requirements or limitations, energy conservation and sustainment costs. Some areas such as water boundaries that cannot be patrolled do not require lighting.

6-2.5 Security Lighting Design.

The security lighting system must aid in the detection of aggressors and assist personnel in the assessment and response to potential threats. All security lighting designs must be coordinated with Security Forces. The type of site lighting system provided depends on the installation environment and intended use.

6-2.5.1 Continuous Lighting.

The most common security lighting system is a series of fixed lights arranged to illuminate a given area continuously.

6-2.5.2 Standby.

With this system, the luminaires are either automatically or manually turned on at times when suspicious activity is detected by security personnel or an intrusion detection system. A standby system creates the impression of activity and may offer a deterrent value while also achieving energy conservation. Consider LED and induction light source systems in lieu of light sources that require re-strike.

6-2.5.3 Moveable.

Movable lighting (stationary or portable) consists of manually operated searchlights that may be lighted during hours of darkness or as needed. This system is normally used to supplement continuous or standby lighting. This system will not be discussed in these criteria.

6-2.6 Controlled Lighting.

Controlled lighting is best used when it is necessary to limit the width of the lighted strip along the perimeter due to adjoining property. Minimize or eliminate silhouetting or illuminating security personnel on patrol. Use fully shielded or U0 rated luminaires mounted in the horizontal plane to reduce glare. Figures 6-1 and 6-2 show different configurations of controlled lighting.

Illumination levels for controlled lighting must be adequate to detect a moving aggressor, either visually or by use of CCTV. Provide fully shielded or U0 rated luminaires mounted in the horizontal plane to minimize glare. Glare may hinder security personnel visibility and interfere with authorized activities or activities outside the installation.

Figure 6-1. Example of controlled lighting: single fence line

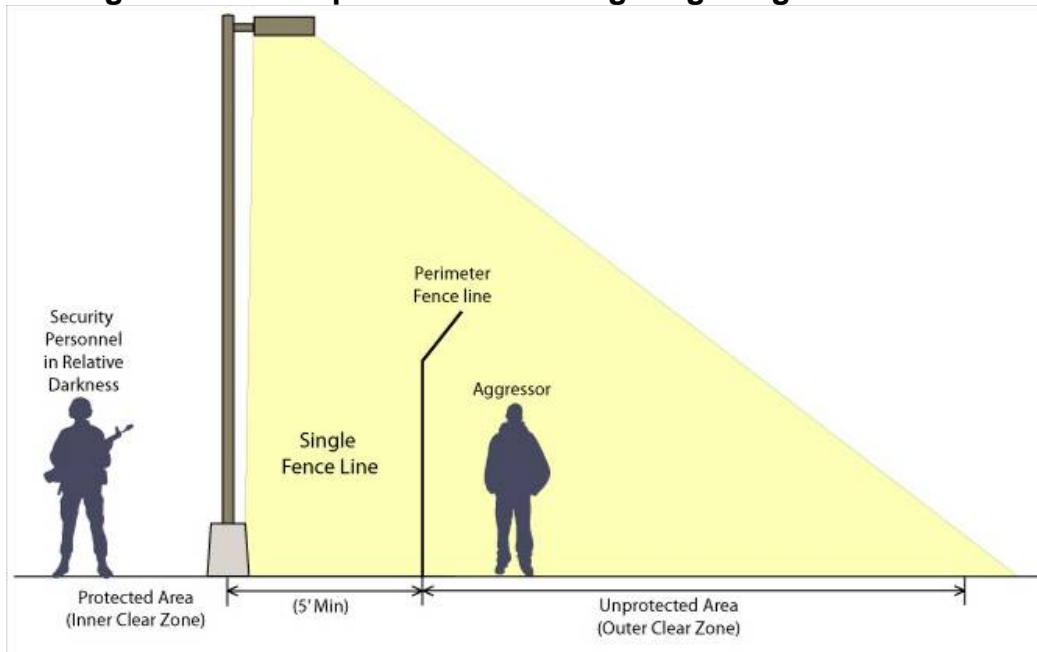
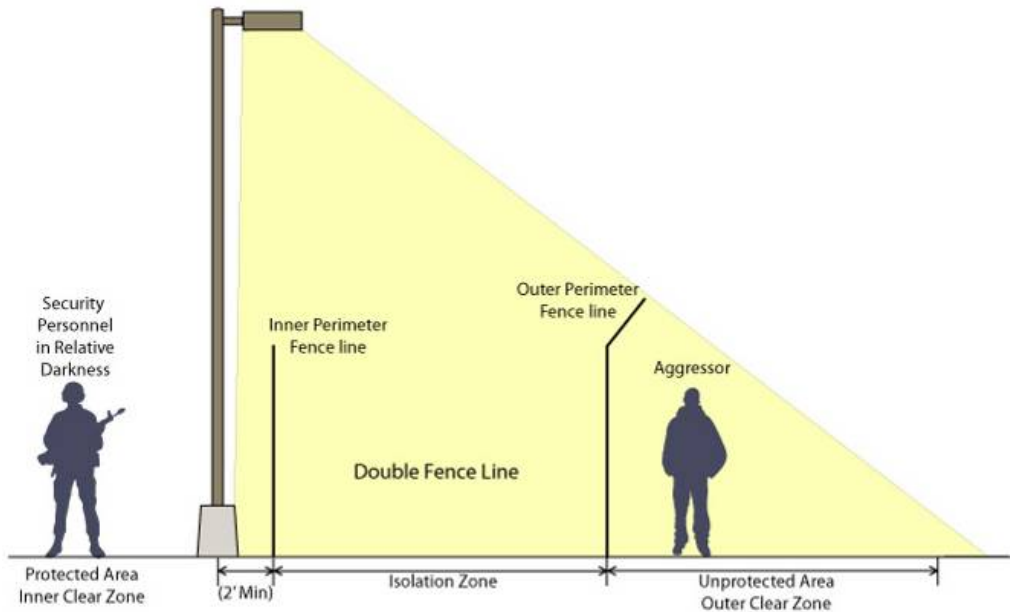

Figure 6-2. Example of controlled lighting: double fence line



6-2.6.1 Glare Projection.

One technique for glare projection lighting is to place lights slightly inside a security perimeter and directed outward. Use glare projection in remote locations when the glare of lights directed across surrounding territory will neither annoy nor interfere with adjacent operations and only when the threat environment dictates. It is a deterrent to potential intruders because it makes it difficult to see inside the area being protected. It also protects security personnel by keeping them in comparative darkness and enabling them to observe intruders at a considerable distance beyond the perimeter. Figure 6-3 and 6-4 show examples of glare projection.

Provide glare projection only to illuminate flat areas which are free of obstructions for a minimum of 100 feet outside the fence. Use glare projection in isolated or expeditionary locations in high threat environments. When designing for glare lighting, the designer must check for light pollution ordinances of the local jurisdiction.

Figure 6-3. Example of glare projection: single fence line

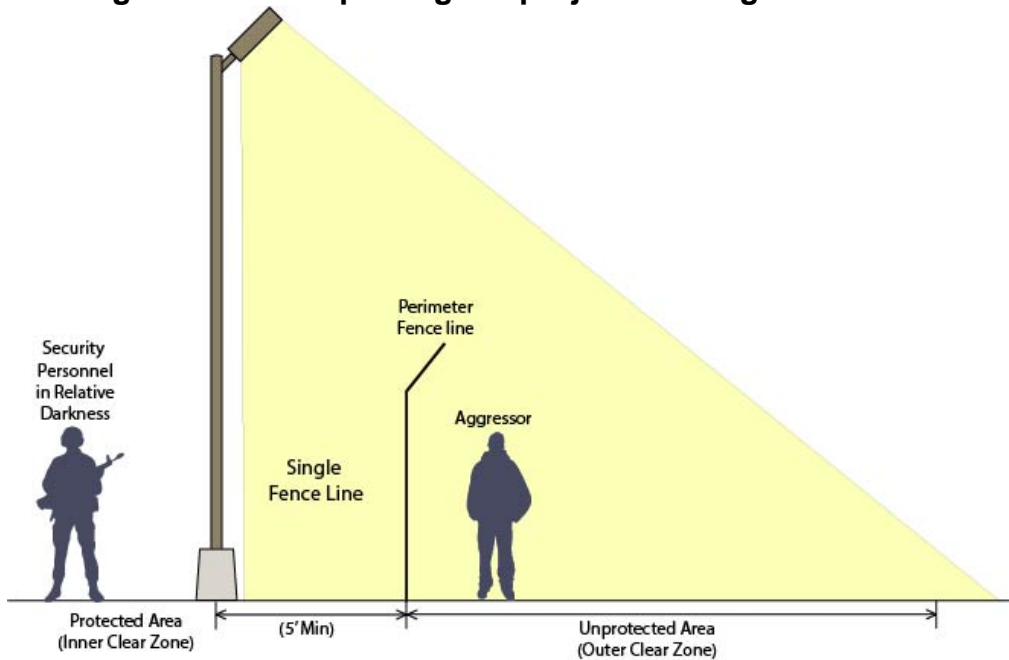
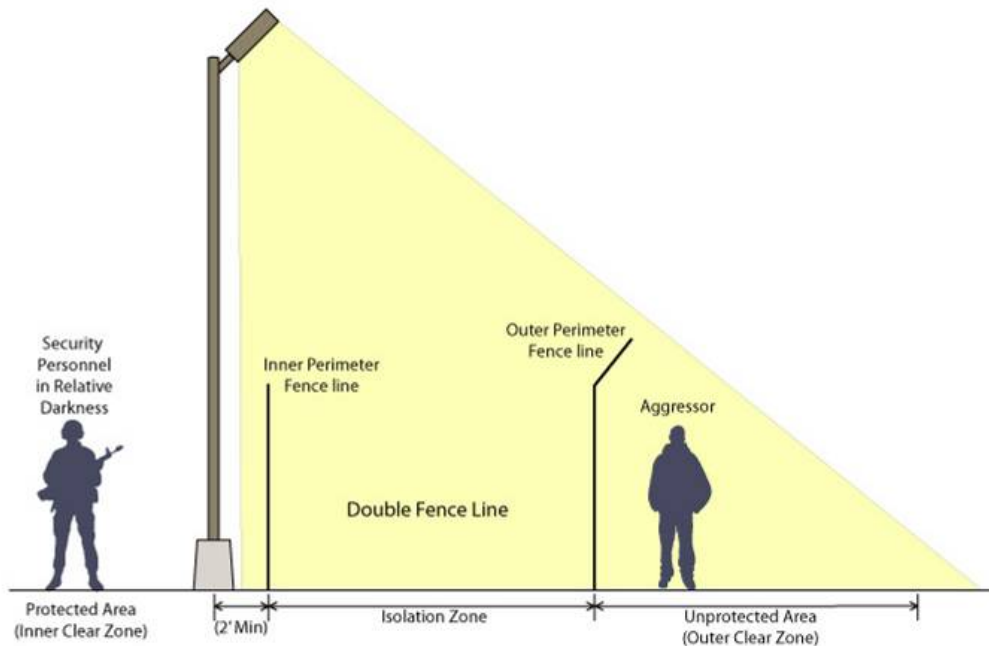

Figure 6-4. Example of glare projection: double fence line



6-2.7 Security Lighting Criteria.

In all cases, mission safety or operational requirements govern over security lighting requirements. For example, if security lighting requires 0.2 fc, and a lighting level of 5 fc is required to perform a task or operation, then 5 fc will be the requirement. Illuminance values appropriate for security personnel may range from a minimum of 1 lux (0.1 fc) for large open areas to a minimum of 100 lux (10 fc) in area of ID checks for entry control

points. If guards must perform any written task (such as inside a guardhouse), the illuminance on the task plane may reach an average 300 lux (30fc). Illuminance values in excess of this may inhibit the individual's ability to adapt to lower lighted areas outside. Refer to UFC 4-021-02 for additional information.

6-2.7.1 Low Level of Protection (LLOP).

Illumination is only required at building entries and exits. Use low brightness and well shielded luminaires so that it does not become a glare source in the much darker surroundings.

6-2.7.2 Medium Level of Protection (MLOP).

Requires LLOP criteria and illumination of the building exterior. Fully shielded or U0 rated luminaires mounted on the building wall can illuminate the exterior of the building without adding light to the surrounding area or cause light trespass to neighboring properties.

6-2.7.3 High Level of Protection (HLOP).

Requires MLOP criteria and illumination of the area around the facility. This lighting may still be accomplished with wall mounted lighting on the building. By using a different luminaire distribution, light can be directed to the surrounding area rather than just at the building. For larger areas, poles may be necessary to light further from the building. With fully shielded or U0 rated luminaires, a perimeter width of 2-3 times the mounting height can be illuminated. When a perimeter fence is required for security, HLOP would dictate illumination of the perimeter fence including any required clear or isolation zones to aid in the detection, assessment, and interdiction of aggressors by security forces. Use controlled lighting, except when dictated by local threat environment.

6-3 SECURITY LIGHTING APPLICATIONS.

\1\ Refer to the Chapter on Security Lighting Applications for additional information. /1/.

6-3.1 Building Entrances and Exits.

Increasing the light level at the building entrance guides visitors and other personnel to the appropriate building entry. It also serves as exit lighting to guide individuals out of a building for life safety in case of an emergency. The security lighting at these locations protects against forced entry and provide enough light for threat assessment. Building entrances and exits must be lighted for all levels of protection. Use concealed, fully shielded or U0 rated luminaires and/or low brightness sources to limit glare while still increasing brightness.

6-3.2 Building Exterior.

Lighting of the building frequently includes some area lighting as well. By using fully shielded or U0 rated, wall mounted luminaires; both the building and the adjacent area can be illuminated. Mounting luminaires at the top of the facade and aiming the light

down will increase the facade brightness and also reduce light trespass and light pollution.

6-3.3 Perimeter Lighting.

Illumination of a restricted area perimeter when required includes the exterior and interior clear zones adjacent to the fence or, in some applications, the area between a dual fence line (isolation zone). Provide poles, power circuits, and transformers within the protected area. Coordinate pole locations with the user to ensure that the applicable egress requirements and patrol routes of the clear zone are not violated. The distance of poles from a single fence line will not be less than 5 feet and 2 feet for a dual fence line. Perimeter lighting can be either continuous or standby, controlled or glare projection depending on the application and local threat environment.

6-3.4 Entry Control Facilities.

Refer to UFC 4-022-01 for Entry Control Facility Criteria. Entry Control Facilities are separated into several zones. The lighting design for each zone is described in the following paragraphs.

6-3.4.1 Approach Zone.

Illuminate the approach zone to lead motorists safely to the access zone. Use fully shielded or U0 rated luminaires mounted in the horizontal plane to minimize glare. To reduce adaptation issues for the motorist, gradually increase (transitional lighting) lighting levels as the motorist approaches the access zone. Motorist's eyes take time to adjust to sudden changes in light level, low to high and especially high to low. Increased light levels over the length of this zone will give the driver a few seconds to adapt to the brightness. It is important in both the Approach Zone and the Response Zone. Extensive discussion of transitional lighting can be found in IES RP-22-11, *Tunnel Lighting*. To reduce glare for security personnel, provide signage to instruct motorists to turn off headlights as they approach the access zone.

6-3.4.2 Access Zone.

Lighting in the access zone provides the highest light levels in the entry control facility. The lighting system must provide for identification and inspection. For most of the access zone, fully shielded or U0 rated luminaires will provide adequate lighting for most of these visual tasks. However, vertical illuminance on motorists' faces can be improved with the use of low brightness light sources (less than 3500 lumen light source output). Luminaires mounted to the side and behind security personnel will improve identification tasks.

6-3.4.3 Response Zone.

From the access point, gradually return roadway lighting to lower light levels (transitional lighting) while still providing adequate uniformity. Provide fully shielded or U0 rated luminaires mounted in the horizontal plane to minimize glare for motorists and

security personnel in the response zone. Use a glare rating not to exceed G2. In addition, provide signage to instruct motorists to turn headlights back on after leaving the access zone.

6-3.4.4 Pedestrian ACP.

Pedestrian zones must provide light for both pedestrians and security personnel. Pedestrians must have a clear view of gates and card access readers and security personnel must be able to see pedestrians approaching the ACP. Provide fully shielded or U0 rated luminaires mounted in the horizontal plane to minimize glare. Use a glare rating not to exceed G2.

6-3.4.5 Vehicle Inspection.

In areas where security personnel must identify visitors, check credentials, and read shipping manifests, lighting must not interfere with the operations while vehicles approach, stop for inspection, and proceeds. Having to continually adapt to different illuminance and brightness levels could lead to eyestrain and reduced performance by security personnel. Provide additional task lighting from behind the guard and light the person to identify or the vehicle to inspect.

6-3.4.6 Guard Shack.

Inside the guard shack, task lighting must be provided for reviewing identifications, paper work, and possibly computer tasks. However, the interior light levels must be kept at a lower ambient light level than the exterior. Otherwise, the security personnel will have reduced visibility and those approaching the shack will have a clear view of the interior. While the ambient light level may be very low, task lighting at a desk or workstation can still be increased to a higher level. The location and shielding of interior lighting must minimize the chance of veiling reflections on the glass that may limit visibility to the outside. All luminaires must be dimmable to adjust inside lighting levels. Do not use colored light for task lighting when color is to be distinguished in the task.

6-3.4.7 Over Watch Position.

These locations must maintain an unobstructed view through the access and response zones. Additionally, inside the over watch itself, lighting must be kept to extremely low levels or eliminated entirely to prevent the lighting of the security personnel. All luminaires must be dimmable to adjust lighting levels. While red colored light has been used in such applications to maintain the eye's dark adaptation, do not use colored light for task lighting when color is to be distinguished in the task.

6-3.5 Waterfront.

Refer to UFC 4-025-01 for Waterfront Security Criteria. Waterfront areas consist of a defined perimeter (landside and waterside), restricted area, entry control facilities at the entrance into the waterfront area, access control points located at each pier, and pedestrian access control points along the perimeter. In waterfront areas, utilize high mast lighting to reduce the number of poles minimizing obstructions to waterfront

operations and maintaining clear paths for equipment and vehicles. Provide fully shielded or U0 rated luminaires mounted in the horizontal plane to limit direct and reflected glare. Use a glare rating not to exceed G2. Use metal halide (MH), induction, or LED light sources to improve color rendering and nighttime visibility. In some regions, white light sources may interfere with the marine environment. Coordinate marine issues with the local environmental authority.

\1\ Security lighting can visually interfere with lighting used as aids to navigation (ATON) by ships. Lighting ashore can camouflage, outshine, or otherwise conceal ATON. Ensure that lighting ashore and in the waterfront compound does not conflict with or otherwise conceal the ATON lights. Coordinate security lighting requirements with Port Operations. \1\

6-3.5.1 Piers, Wharves and Shipyards.

/1/ Provide fully shielded or U0 rated luminaires to limit glare and uplight. Use a glare rating not to exceed G2. In general, high mast lighting provided for waterfront operations supply adequate illuminance for security requirements. Coordinate number, height, and location of poles and the associated concrete pedestals to minimize obstructions to pier, wharf and shipyard operations. Refer to UFC 4-152-01 for Pier and Wharf operational lighting requirements. \1\ Refer to 29 CFR 1915.82 for the minimum lighting intensity requirements for shipyards. /1/

6-3.5.2 Pierhead and Wharf Guard Towers.

Lighting inside the guard towers must not degrade security personnel's nighttime visibility. All luminaires must be dimmable and mounted at or near desk level. Switch task and general lighting separately. When colors are not used to distinguished tasks (colored lights or controls for alarm annunciations), consider red light sources for task lighting to reduce adaptation problems. Manually operated searchlights may be required to assist security personnel to locate and assess waterside threats within the restricted zone. Lighting controls must be under the direct control of security personnel. Coordinate lighting requirements with security personnel.

6-3.5.3 Water Surface.

High mast lighting on pier and wharfs provide adequate illuminance for security requirements. Glare, poor distribution, and excessive light levels reduce security personnel's ability to assess surface and subsurface threats.

6-3.5.4 Underwater Lighting.

Underwater lighting is not normally required for detection of subsurface threats and is discouraged due to limited benefit, high installation cost, and maintenance issues.

6-3.5.5 Underdeck Lighting.

Dedicated luminaires located beneath the pier are not normally required and are discouraged due to limited benefit, high installation cost, and maintenance issues.

6-3.5.6 Lower Deck Lighting.

On the lower deck of a double deck pier, provide utility and work areas with illuminance levels based on the tasks performed. Lower deck lighting in roadway and open areas must be multilevel and divided into sections to localize lighting control. Alternate control of luminaires between photocell and manual light switch, or implement an intelligent control system. Provide an average of 0.5 fc (5.4 lx) with luminaires under photocell control. To reduce energy consumption, consider occupancy or vacancy sensors for control of lighting in enclosed spaces.

6-3.6 CCTV camera.

Cameras respond to a luminous environment differently than the human eye. The field of view of a camera refers to the extent of the scene that can be viewed at one time. Some devices may use motorized swivels to pan across a scene and increase the viewing area. Cameras adjust the view based on the brightest point in this field. If it must adjust for a hot spot, areas under low illuminance levels may not be visible at all. Uniform illuminance and fully shielded or U0 rated luminaires are vital to limit hot spots and improve CCTV system performance. Figure 6-5 illustrates how a large portion of the camera's view may be washed out if it must adjust to an excessively bright light source. Any luminaire that falls within the camera's field of view at any time must be shielded. If a light source can be seen directly by the camera, the glare and high contrast will limit the visibility of the entire scene. Therefore, the source of illumination is best located above the level of the camera. Refer to UFC 4-021-02 *Electronic Security Systems* for additional information.

Figure 6-5. CCTV camera's view of scene with excessive glare



6-3.6.1 Color Rendering Index.

For color cameras, the color rendering index of the sources lighting the area must be above 80. Color rendering is less important for monochrome systems. Avoid high pressure sodium light sources as their limited spectral distribution may render a fuzzy image.

6-3.6.2 Uniform Vertical Illuminance.

CCTV cameras typically record objects and people in elevation. Therefore, the security lighting system must provide adequate and uniform vertical illuminance. As in many security lighting applications, the amount of vertical illuminance is far more important than horizontal. Vertical illuminance criteria average is 0.2 to 0.5 footcandles (2-5 lux) at 5 feet (1524mm) above the ground. Uniformity criteria is 4:1 average to minimum. These criteria refer to vertical illuminance values measured in the same direction of the camera line of sight. Vertical illuminance does not need to be this high in all directions. Color cameras may require higher light levels than monochrome cameras. Review camera manufacturer recommendations and coordinate with the security system designer when designing the lighting system.

6-3.6.3 Infrared (IR) Cameras.

IR cameras utilize IR sources to illuminate the field of view. Light in the IR spectrum is not visible to the human eye. IR cameras then pick up the reflections of these wavelengths from objects in the area.

6-3.6.4 Thermal Imaging.

Devices using thermal technology do not require any light source to operate. They create images based on the heat differences between humans, vehicles, the ground, and foliage. Unlike other camera technologies, thermal imagery is not affected by glare from headlights or light sources. While this technology can indicate the presence of people and objects in complete darkness, they do not provide the detailed images obtainable from visible light or IR cameras.

6-3.6.5 Specific Lighting Criteria.

The specific lighting criteria and design issues may vary with application. Table 6-1 summarizes the minimum (not average) horizontal and vertical illuminance levels for typical facility applications. The inner clear zone noted in the table refers to the area along a perimeter fence line within the facility or installation. The isolation zone refers to the area between a double fence line. The outer clear zone describes the area along the perimeter fence on the outside of the protected area. Isolation and clear zones are typically 30 feet (9.1 meters) in width. It is important to note however that overlighting can cause just as many visibility problems as underlighting.

6-4 ELECTRICAL REQUIREMENTS.

Backup power is not required for all security lighting systems. The assessment of risk and asset value will determine this need. For critical security lighting systems, several different types of systems are available for providing backup power in the event of a power outage. All offer various advantages and disadvantages. They vary in amount of time that they can provide power, amount of downtime between a power outage and backup power, and cost. The back-up power system must also consider the re-strike time of some light sources. Metal halide and high pressure sodium light sources both

require a certain amount of time to cool-down before they can be re-ignited. This time may reach up to 15 minutes. If these sources are used, an intermittent light source may be required. Consider LED and induction light source systems that are instant on in lieu of light sources that require re-strike. Refer to service specific guidance regarding facilities and equipment authorized backup power.

6-4.1 Generators

Generators are commonly used to provide backup power but have some downtime between the outage and when the generator restores power. Minimum downtime can be as low as seconds. While this is one of the least expensive solutions, operations must be able to sustain the short period of darkness.

6-4.2 Uninterrupted Power Supply

An Uninterrupted Power Supply (UPS) is a battery source that provides instantaneous power in case of a power loss. UPS systems have a high initial cost and are expensive to maintain. Therefore, only provide a UPS for security lighting systems associated with the protection of critical assets or security operations when continuous, full brightness lighting is required.

6-4.3 Flywheels

Flywheels provide instantaneous power in the case of power loss in the form of the kinetic energy in a constantly rotating wheel. This energy can be harnessed immediately in the event of a power outage and used to power critical lighting. These devices vary widely in price and capacity.

6-4.4 Battery Backup

Individual battery packs are available for some luminaires. In the event of a power outage, these packs can power the lighting for times ranging from five minutes to two hours, depending on the battery capacity. For LED, fluorescent or induction sources, the battery will power the driver, ballast or generator directly although the light source may not provide full light output.

6-4.5 Partial Back-up Systems.

Light sources requiring a re-strike can be specified with a partial back-up system such as quartz-restrike. In this case, the luminaire contains a primary light source, such as metal halide, and then a smaller quartz light source. In the event of a power outage, the metal halide source will require a cool down time before it can be re-ignited. During this period the quartz light source uses generator-supplied power to light the area. The lighting level will not be as high, but interim lighting will be provided. When the primary source returns to full brightness, the quartz light source is extinguished. A separate, complete back-up lighting system does not provide an economical or effective design solution. Consider LED or induction light source systems in lieu of light sources that require re-strike.

6-4.6 Circuiting Techniques.

Circuiting luminaires onto separate circuits in the same space will not provide backup power but will limit vulnerabilities during a fault or circuit failure. If the lighting system is divided onto two or more circuits, the loss of one will not affect the entire lighting system. Install multiple circuits, except where their use is clearly impractical. Locate the overcurrent devices, transformer, and wiring within the protected area. Locate circuits underground to minimize the possibility of sabotage or vandalism. Provide simplicity and economy in equipment and design. To minimize security degradation during faults, feeders may be 3-phase, 4-wire with single pole overcurrent devices at the service equipment. Consecutive luminaires will be connected to alternate phases of 3-phase feeders.

6-4.7 Controls.

On-off control will be automatic or manual as appropriate.

6-4.7.1 Automatic.

Perimeter and area lighting on-off control will be automatic and will be activated during periods of darkness, at other times when visibility is reduced, or by electronic security systems. In expeditionary environments, automatic on-off control must be capable of being deactivated which may require either automatic or manual on-off control depending upon the site. In some applications, motion sensors can be used to turn on lights when someone approaches. This indicates to patrols or other personnel that activity is taking place in a particular area. Such control strategies will reduce energy consumption and may also startle and deter unsophisticated criminals.

6-4.7.2 Manual.

Wherever manual on-off control is appropriate, on-off controls will be accessible to and operable only by authorized personnel. Systems that are designed to remain off until needed, will have on-off control at the surveillance location and will meet instant-on requirements. LED or induction is the appropriate light source choice for this type of application.

Table 6-1. Minimum Lighting Criteria for Unaided Guard Visual Assessment

Application			Width Feet (m)	Minimum Illuminance (All Lighted Areas)		Maximum Uniformity
Type	Lighting	Area		Locations to Light	Footcandles (lux) ^a	(Max : Min)
Perimeter	Controlled	Inner Clear Zone	6.1-9.1 (20-30) ^c	Outer edge fence	0 (0) ^e	10:1
	Controlled	Outer Clear Zone	9.1(30) ^d	Outer edge	0.2 (2) or 0.4 (4) ^g	10:1
	Controlled	Isolation Zone ^f	9.1 (30)	Between fence lines	0.5 (5) or 1.0 (10) ^b	6:1
Building Lighting	Controlled	LLOP	--	Building Entry and Exits	Refer to 5-7.1 and 5-7.2	20:1
	Controlled	MLOP	--	Same as LLOP and exterior walls.	0.2 - 0.5 (2 - 5)	15:1
	Controlled	HLOP	9.1 (30)	Same as MLOP and area around facility.	0.5 - 1.0 (5 - 10)	10:1
Entry Control Facility	Controlled	Pedestrian	--	Entry	2 (21)	3:1
		Vehicular (Approach/Response Zones)	15 (50)	Pavement and sidewalk	1 (10)	4:1
		ID Verification	--	Guard station	10 (100)	3:1
		Search Areas	--	Pavement	10 (100)	3:1

- a. Horizontal plane at 3 feet (914 mm) above finished grade unless otherwise noted.
- b. Vertical illuminance 6 inches (152 mm) above finished grade.
- c. Width of inner clear zone is asset dependent. Refer to Service guidance for asset being protected.
- d. Width of outer clear zone is asset dependent (typical clear zones is 30 feet (9144 mm)). Refer to Service guidance for asset being protected. Glare projection may be required in areas with larger clear zones such as forward areas or high threat environments or when the assessment zone is extended beyond the clear zone.
- e. Minimize illuminance in inner clear zone to prevent illuminating security personnel. Some applications may require illumination of inner clear zone (backlighting).
- f. Only applies to dual fence line applications.
- g. Vertical illuminance 3 feet (0.9 meters) above finished grade, at outer edge.

CHAPTER 7 SECURITY LIGHTING APPLICATIONS

7-1 INTRODUCTION.

This section identifies typical security lighting applications. Each application details a conceptual lighting design example. Designers must meet the lighting performance and controls requirements.

7-2 CALCULATIONS FOR SECURITY LIGHTING.

Computer-generated photometric plans for each space are required to verify proposed luminaires and locations meet the required performance criteria of the design using the applicable light loss factor (LLF). Photometric plan submittals must include:

- Horizontal illuminance measurements at workplane or other designated height above finished floor, taken at a maximum of every one foot (305 mm).
- Minimum and maximum illuminance levels.
- Average maintained illuminance level.
- Average to minimum and maximum to minimum ratios for horizontal illuminance.
- Lighting power density (Watts per square foot).
- LLF

7-3 ENTRY CONTROL FACILITY.

7-3.1 Access Control Points – Approach Zone.

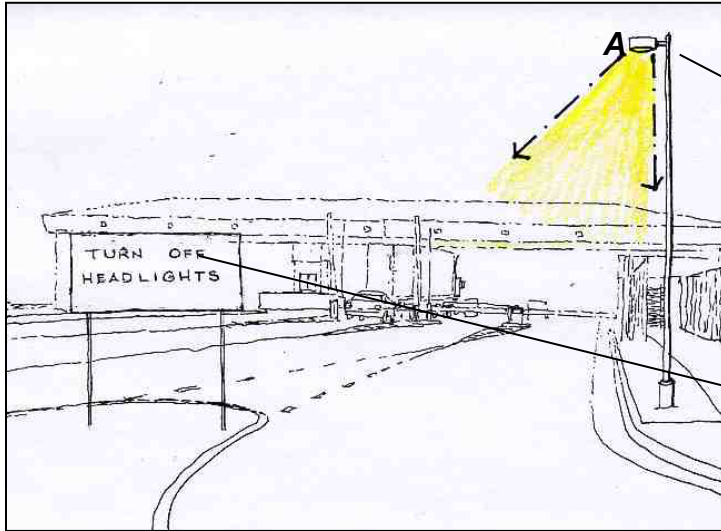

Fully shielded or U0 rated luminaire reduces glare for approaching drivers and for security personnel. Increase light level at approach zone to provide transition to the higher level at the access control point.

Post signs that instruct motorists to turn off headlights when approaching the access control zone.

EQUIPMENT REQUIREMENTS:

	LUMINAIRE	LIGHT SOURCE	CONTROLS
A	<i>Pole mounted, fully shield or U0 roadway luminaire.</i>	<i>LED, induction, or metal halide.</i>	<i>On at dusk. Reduce light output during periods of closure. Off within 15 minutes of sunrise.</i>

PERFORMANCE REQUIREMENTS:

Target Criteria	Daytime	Nighttime
<i>Horizontal Illuminance (Minimum ±10%)</i>	<i>NA</i>	<i>1 fc (10 lux)</i>
<i>Uniformity (Maximum to Minimum)</i>	<i>NA</i>	<i>4:1 maximum to minimum</i>

CRITICAL DESIGN ISSUES:

- See Response Zone and UFC 4-022-01 Exterior Lighting for additional information on transition lighting.
- Provide U0 and G2 or less luminaires with low lumen output to minimize glare and light pollution.

7-3.2 Access Control Points – Access Zone.

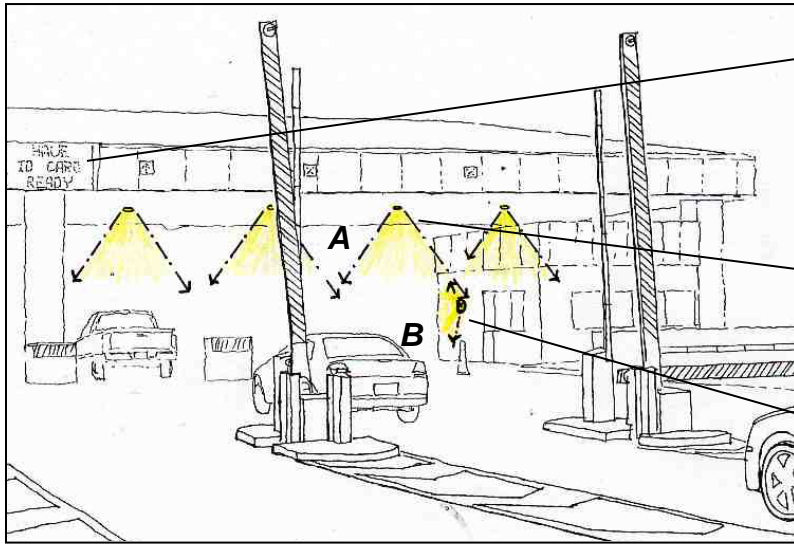

Do not backlight illuminated signage. This will reduce contrast of sign.

Recessed or surface mounted downlights eliminate glare for approaching drivers.

Low brightness luminaire behind and to side of inspection personnel to light the approaching vehicle and driver.

EQUIPMENT REQUIREMENTS:

	LUMINAIRE	LIGHT SOURCE	CONTROLS
A	Recessed or surface mounted U0 downlights in canopy.	LED, induction, fluorescent, or metal halide.	On at dusk. Reduce light output during periods of closure. Off within 15 minutes of sunrise.
A ALT	Indirect uplights and U0 downlights for open canopy.	LED, fluorescent or metal halide.	On at dusk. Reduce light output during periods of closure. Off within 15 minutes of sunrise.
B	Surface mounted low brightness luminaire.	LED or fluorescent.	On at dusk. Reduce light output during periods of closure. Off within 15 minutes of sunrise.

PERFORMANCE REQUIREMENTS:

Target Criteria	
Horizontal Illuminance (Minimum ±10%)	1 fc (10 lux)
Uniformity (Maximum to Minimum)	4:1 maximum to minimum

CRITICAL DESIGN ISSUES:

- Refer to UFC 4-022-01 Security Engineering: Entry Control Facilities / Access Control Points for additional criteria on signage.

7-3.3 Access Control Points – Access Zone.



Locate low brightness luminaire behind and to side of inspection personnel to light the approaching vehicle and driver. This will also eliminate glare for the guard.

EQUIPMENT REQUIREMENTS

	LUMINAIRE	LIGHT SOURCE	CONTROLS
A	<i>Surface mounted low brightness (G1) luminaire.</i>	<i>LED or fluorescent.</i>	<i>Manual on. Manual off.</i>

PERFORMANCE REQUIREMENTS:

Target Criteria	
<i>Horizontal Illuminance (Minimum $\pm 10\%$)</i>	<i>10 fc (100 lux)</i>
<i>Uniformity (Maximum to Minimum)</i>	<i>3:1 maximum to minimum</i>

CRITICAL DESIGN ISSUES:

- Luminaires located on the wall must be less than 3500 initial light source lumens.

7-3.4 Access Control Points – Pedestrian Entry.

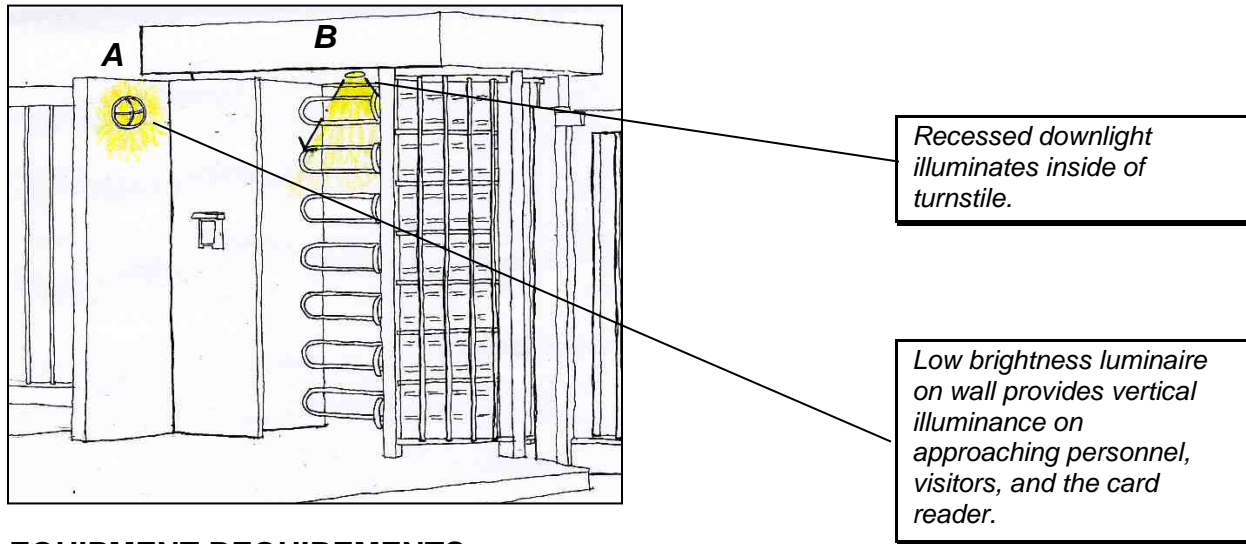

Recessed downlight illuminates inside of turnstile.

Low brightness luminaire on wall provides vertical illuminance on approaching personnel, visitors, and the card reader.

EQUIPMENT REQUIREMENTS:

	LUMINAIRE	LIGHT SOURCE	CONTROLS
A	Surface mounted low brightness (G1) luminaire.	LED or fluorescent.	On at dusk. Reduce light output during periods of closure. Off within 30 minutes of sunrise.
B	Recessed U0 downlight	LED or fluorescent.	On at dusk. Reduce light output during periods of closure. Off within 15 minutes of sunrise.

PERFORMANCE REQUIREMENTS:

Target Criteria	
Horizontal Illuminance (Minimum ±10%)	2 fc (20 lux)
Uniformity (Maximum to Minimum)	3:1 maximum to minimum

CRITICAL DESIGN ISSUES:

- Luminaires located on the wall must be less than 3500 initial light source lumens.
- Locate luminaires to avoid harsh shadows.
- Refer to UFC 4-022-01 *Security Engineering: Entry Control Facilities / Access Control Points* for additional criteria on signage.

7-3.5 Access Control Points – Response Zone.

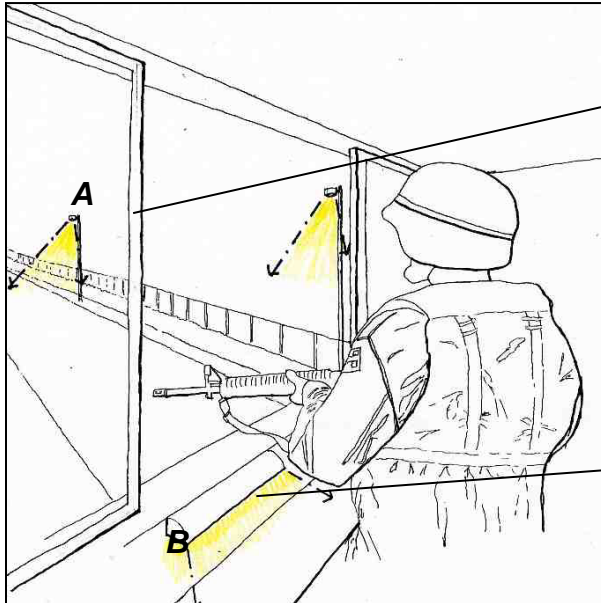

Locate roadway luminaires to prevent glare to occupant of overwatch position.

If interior lighting is necessary, it should be kept dim and at a low mounting height. Use red lights (such as LED) to improve dark adaptation.

EQUIPMENT REQUIREMENTS:

	LUMINAIRE	LIGHT SOURCE	CONTROLS
A	Pole mounted, fully shielded, U0 roadway luminaire with shielding toward the overwatch position if necessary.	LED, induction, or metal halide.	On at dusk. Off within 15 minutes of sunrise.
B	Surface mounted task light.	LED or fluorescent. Use red LEDs to improve dark adaptation.	Manual on. Manual dimming. Manual off.

PERFORMANCE REQUIREMENTS:

Target Criteria	Task Surface	Roadway
Horizontal Illuminance (Average $\pm 10\%$)	10-20 fc (100-200 lux)	3 fc (30 lux)
Illuminance Uniformity	NA	3:1 maximum to minimum

CRITICAL DESIGN ISSUES:

- Roadway luminaires must be located either below eye level of the overwatch position or high enough above it to avoid direct glare.

7-4 OTHER AREAS.

7-4.1 Under Vehicle Inspection.

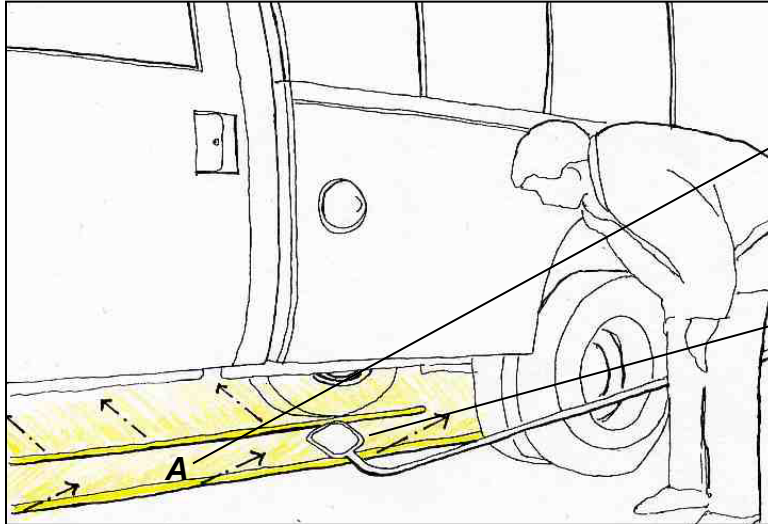

LED or fiber optic luminaire uplights the underside of incoming vehicles.

Mirror may be used for under-vehicle inspections.

EQUIPMENT REQUIREMENTS:

	LUMINAIRE	LIGHT SOURCE	CONTROLS
A	Ground mounted uplight.	LED or fiber optic.	Manual on. Manual dimming. Manual off.
A ALT	Airfield omni-directional, semi-flush taxiway luminaire.	LED.	Manual on. Manual dimming. Manual off.

PERFORMANCE REQUIREMENTS:

Target Criteria	Daytime	Nighttime
Horizontal Illuminance (Minimum $\pm 10\%$)	10 fc (100 lux) at 1'-0" (305mm) AFF facing downward	
Uniformity (Maximum to Minimum)	3:1 maximum to minimum	

CRITICAL DESIGN ISSUES:

- Luminaire brightness must be kept at a low level.
- Uniformly illuminate the underside of the vehicle.

7-4.2 Controlled Perimeters - Single Fence Line.

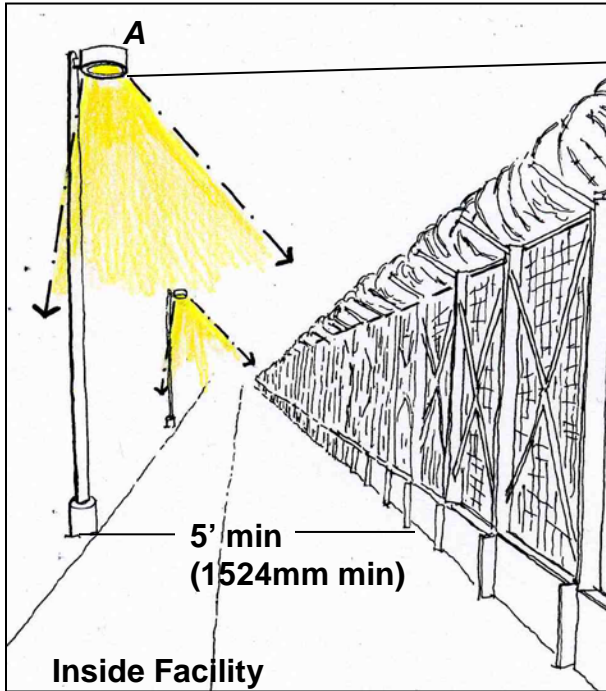

Pole mounted, fully shielded or U0 luminaires provide uniform illuminance and limit glare and light trespass.

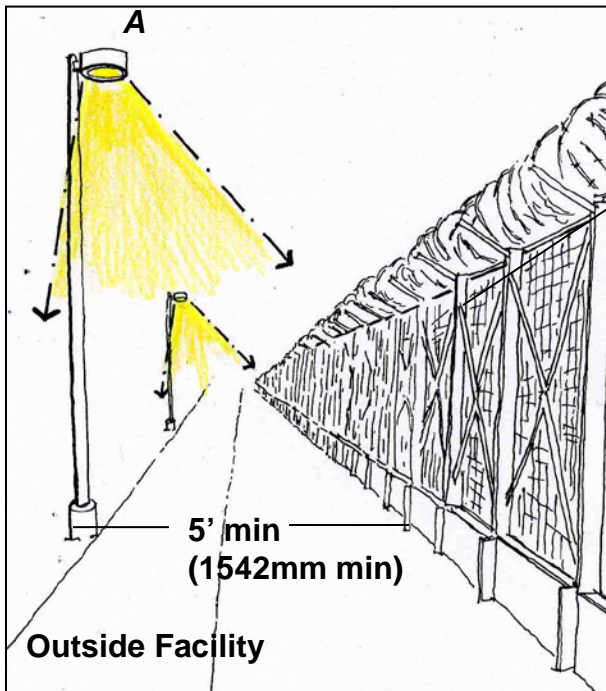

Increasing the brightness on the outside of the fence permits vision through for someone on the inside, but limits it for those on the outside.

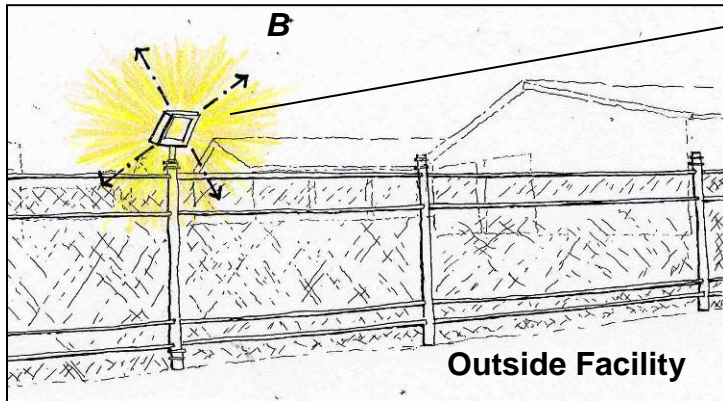

In high threat areas or expeditionary locations, glare projection strategies may be used. In these situations, aim luminaires away from the perimeter to illuminate approaching intruders and limit visibility into the protected area.

EQUIPMENT REQUIREMENTS:

	LUMINAIRE	LIGHT SOURCE	CONTROLS
A	<i>Pole mounted, fully shielded or U0 area luminaire located opposite the fencing or incorporated into the fence with break-away connections. (This connection in a pole will not support the weight of a person and will cause the pole to collapse if climbed.)</i>	<i>LED, induction, or metal halide.</i>	<i>On at dusk. Off at specified time.</i>
B	<i>Pole mounted, floodlight aimed away from the perimeter.</i>	<i>LED, induction, or metal halide.</i>	<i>On at dusk. Off at specified time.</i>

PERFORMANCE REQUIREMENTS:

Target Criteria	
<i>Horizontal Illuminance (Minimum ±10%)</i>	<i>0.2-4 fc (2-40 lux)</i>
<i>Uniformity (Maximum to Minimum)</i>	<i>10:1 maximum to minimum</i>

CRITICAL DESIGN ISSUES:

- Provide U0 rated and G2 or less luminaires with low lumen output to minimize glare and light pollution.
- Uniformly illuminate the area to minimize shadows along the perimeter.
- Coordinate lighting system with emergency backup power availability.

7-4.3 Restricted Area.

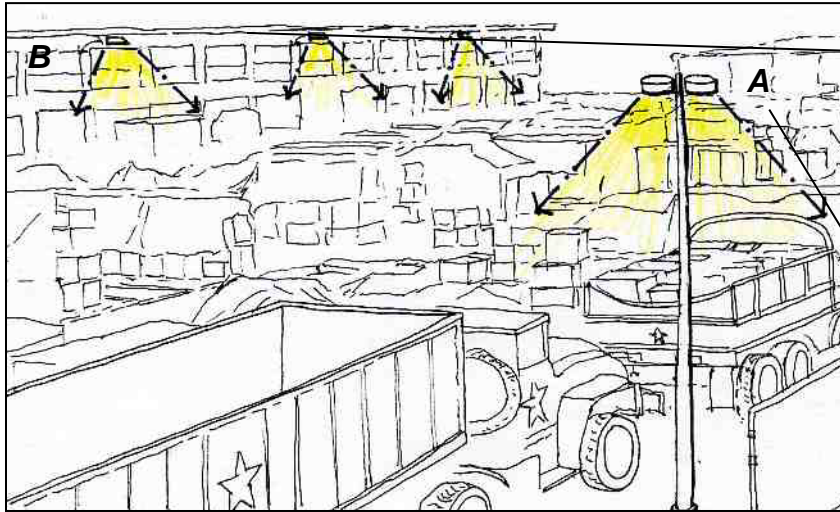

Use wall mounted luminaires when possible to minimize equipment cost.

Pole mounted luminaires provide uniform illuminance and minimize shadows.

EQUIPMENT REQUIREMENTS:

	LUMINAIRE	LIGHT SOURCE	CONTROLS
A	<i>Pole mounted, fully shielded or U0 area luminaire.</i>	<i>LED, induction, or metal halide.</i>	<i>On at dusk. Reduce light output during periods of reduced activity Increase light output for operational requirements. Off within 15 minutes of sunrise.</i>
B	<i>Wall mounted, fully shielded or U0 area luminaire.</i>	<i>LED, induction, metal halide, or compact fluorescent.</i>	<i>On at dusk. Reduce light output during periods of reduced activity Increase light output for operational requirements. Off within 15 minutes of sunrise.</i>

PERFORMANCE REQUIREMENTS:

Target Criteria	
<i>Horizontal Illuminance (Minimum ±10%)</i>	<i>0.2-5 fc (2-50 lux)</i>

CRITICAL DESIGN ISSUES:

- Provide U0 rated and G2 or less luminaires with low lumen output to minimize glare and light pollution.

7-4.4 Magazines.

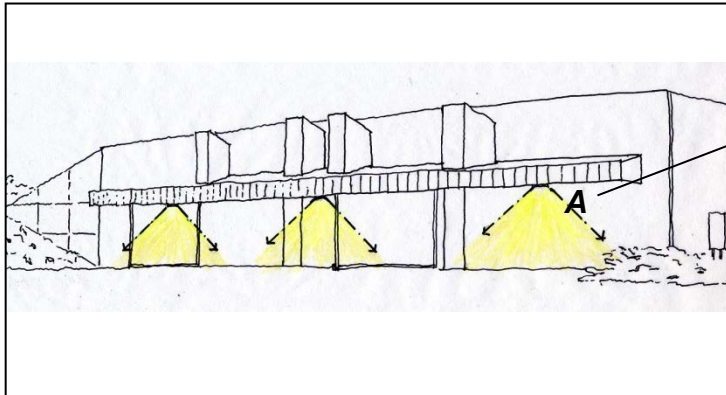

Fully shielded or U0 area luminaire mounted under canopy lights the door area while minimizing glare.

EQUIPMENT REQUIREMENTS:

	LUMINAIRE	LIGHT SOURCE	CONTROLS
A	Canopy mounted, fully shielded or U0 area luminaire.	LED, induction, or metal halide.	On at dusk. Reduce light output during periods of reduced activity Increase light output for operational requirements. Off at preset designated time.

PERFORMANCE REQUIREMENTS:

Target Criteria	
Horizontal Illuminance (Minimum $\pm 10\%$)	0.2-5 fc (2-50 lux)

CRITICAL DESIGN ISSUES:

- Provide U0 and G2 or less luminaires with low lumen output to minimize glare and light pollution.
- Coordinate lighting system with emergency backup power availability.

7-4.5 Piers.

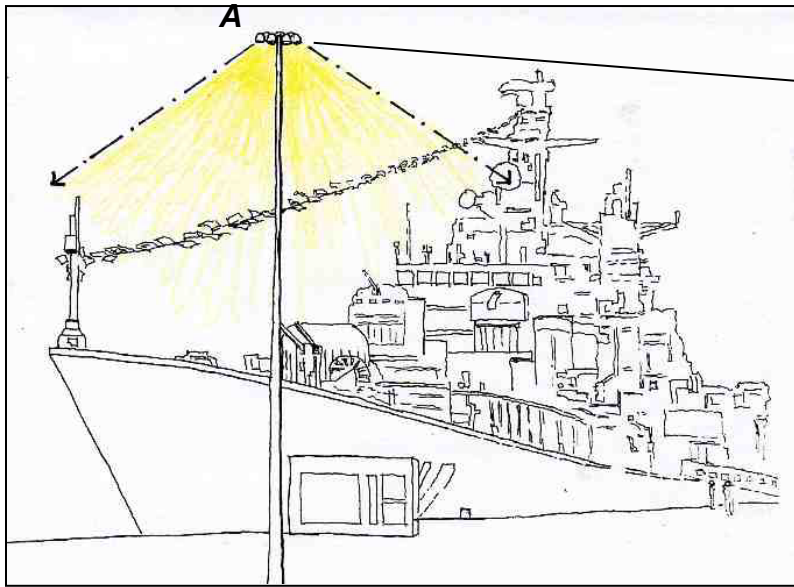

High mast luminaires provide uniform illuminance and minimize the number of poles necessary.

EQUIPMENT REQUIREMENTS:

	LUMINAIRE	LIGHT SOURCE	CONTROLS
A	High mast fully shielded or U0 luminaire.	Metal halide or LED.	On at dusk. Off at preset designated time.

PERFORMANCE REQUIREMENTS:

Target Criteria	Active Work Areas	Other Areas
Horizontal Illuminance (Minimum $\pm 10\%$)	3-5 fc (30-50 lux)	5 lux (0.5 fc)

\1\ Refer to 29 CFR 1915.82 for the minimum lighting intensity requirements for shipyards. /1/

Refer to UFC 4-152-01 for Pier and Wharf operational lighting requirements.

CRITICAL DESIGN ISSUES:

- Provide U0 rated luminaires with low lumen output to minimize glare and light pollution.
- Use the minimum number of high mast lighting poles and luminaires that will provide uniformity.

APPENDIX A REFERENCES

AMERICAN NATIONAL STANDARDS INSTITUTE

<http://www.ansi.org>

ASME A17.1, *Safety Code for Elevators and Escalators*

ASME A17.2, *Guide for Inspection of Elevators, Escalators, and Moving Walks*

ANSI/IEEE C2-2012, *Electric Safety Code*

ANSI C136.41, *Roadway and Area Lighting Equipment – Dimming Control Between an External Locking Type Photocontrol and Ballast or Driver*

AMERICAN SOCIETY OF HEATING REFRIGERATION AND AIR CONDITIONING ENGINEERS

<http://www.ashrae.org>

ANSI/ASHRAE/IES 90.1 (ASHRAE 90.1), *Energy Standard for Buildings Except Low-Rise Residential Buildings*

ANSI/ASHRAE/IES 189.1 (ASHRAE 189.1), *Standard for the Design of High-Performance Green Buildings.*

* The application section of this document (controls) refers to the 2010 version of ASHRAE 90.1 and the 2011 version of ASHRAE 189.1. When UFC 1-200-02 adopts a newer publication year of ASHRAE 90.1 or 189.1 it will have precedence over these UFC requirements.

DEPARTMENT OF DEFENSE

<http://www.dtic.mil/whs/directives/corres/ins1.html>

DoDI 8500.01, *Cybersecurity*, 14 March 2014.

DoDI 8510.01, *Risk Management Framework (RMF) for DoD Information Technology (IT)*. 12 March 2014

DEPARTMENT OF ENERGY

<http://www.energy.gov>

Department of Energy. *Dimming LEDs with Phase-Cut Dimmers: The Specifier's Process for Maximizing Success*. October 2013.

ENERGY POLICY ACT OF 2005

<http://www.wbdg.org/pdfs/epact2005.pdf>

ERNST ORLANDO LAWRENCE BERKELEY NATIONAL LABORATORY

<http://www.lbl.gov>

Tips for Daylighting with Windows, The Integrated Approach.

A Meta Analysis of Energy Savings of Lighting Controls from Commercial Buildings, 2011

ENGINEERING TECHNICAL LETTER

<http://www.wbdg.org>

Engineering Technical Letter (ETL) 11-11: Civil Engineer Industrial Control System Information Assurance Compliance

Engineering Technical Letter (ETL) 11-29: Use of Light Emitting Diode (LED) Fixtures in Airfield Lighting Systems on Air Force Installations and Enduring/Contingency Locations

FEDERAL ENERGY MANAGEMENT PROGRAM

<http://www1.eere.energy.gov/femp/>

Economics for Energy Effective Lighting for Offices

THE HESCHONG MAHONE GROUP

<http://www.h-m-g.com>

Daylighting in Schools

Skylighting and Retail Sales

Skylighting Guidelines (SkyCalc)

ILLUMINATING ENGINEERING SOCIETY OF NORTH AMERICA

<http://www.ies.org/>

HB-10, *IES Lighting Handbook, 2011*

LM-79, *Electrical and Photometric Measurements of Solid-State Lighting Products, 2008*

LM-80, *Measuring Lumen Maintenance of LED Light Sources, 2008*

LM-83, *Spatial Daylight Autonomy (sDA) and Annual Sunlight Exposure (ASE)RP-5, Recommended Practice for Daylighting Buildings, 2013*

RP-6, *Recommended Practice for Sports and Recreational Area Lighting, 2001, Errata 2004*

RP-8, *Recommended Practice for Roadway Lighting, 2014*

RR-03, *IES Lighting Ready Reference, Fourth Edition*

TM-15, *Luminaire Classification System for Outdoor Luminaires, 2011*

TM-21, *Projecting Long Term Lumen Maintenance of LED Light Sources, 2011.*

TM-23, *Lighting Control Protocols, 2011*

Model Lighting Ordinance, 2011

INTERNATIONAL COMMISSION ON ILLUMINATION

<http://www.cie.co.at>

CIE 191, *Recommended System for Mesopic Photometry Base on Visual Performance, 2010.*

LECHNER, NORBERT

Heating, Cooling, Lighting, Design Methods for Architects, Second Edition, 2001.

NATIONAL ELECTRICAL CONTRACTORS ASSOCIATION

<http://www.necanet.org/>

NECA/IES 500, 1998, *Recommended Practice for Installation of Commercial Lighting Systems (ANSI)*

NECA/IES 502, 1999, *Recommended Practice for Installing Industrial Lighting Systems (ANSI)*

NATIONAL ELECTRICAL MANUFACTURERS ASSOCIATION

<http://www.nema.org>

SSL 7a-2015: *Phase-Cut Dimming for Solid State Lighting-Basic Compatibility /2/*

NATIONAL FIRE PROTECTION ASSOCIATION

<http://www.nfpa.org/>

NFPA 70, *National Electric Code*

NFPA 101, *Life Safety Code*

NAVAL FACILITIES ENGINEERING COMMAND

MIL-HDBK-1013/1A, *Design Guidelines for Physical Security of Buildings*.

NAVFAC INSTRUCTION 9830.1, *Sustainable Development Policy*

NEW BUILDINGS INSTITUTE, INC.

<http://www.newbuildings.org>

Advanced Lighting Guidelines, 2001 Edition

SMART LIGHTING RESEARCH CENTER, RENSSELAER POLYTECHNIC INSTITUTE

<http://smartlighting.rpi.edu/>

Evaluation of Visual Function Under Different Light Sources, December 11, 1995.

UL UNDERWRITERS LABORATORY

<http://ulstandards.ul.com/>

UL 1958 *Luminaires*

UL 1598C *Standard for Light-Emitting Diode (LED) Retrofit Luminaire Conversion Kits*

UL 1993 *Self-Ballasted Lamps and Lamp Adapters /3/*

UNIFIED FACILITIES CRITERIA

http://www.wbdg.org/ccb/browse_cat.php?o=29&c=4

UFC 1-200-01, *General Building Requirements*

UFC 1-200-02, *High Performance and Sustainable Building Requirements*

UFC 3-101-01, *Architecture*

UFC 3-260-01, *Airfield and Heliport Planning and Design*

UFC 3-535-01, *Visual Air Navigation Facilities*

UFC 3-600-01, *Fire Protection Engineering for Facilities*

UFC 4-020-01, *DoD Security Engineering Facilities Planning Manual*

UFC 4-021-02, *Electronic Security Systems*

UFC 4-022-01, *Security Engineering: Entry Control Facilities/Access Control Points*

UFC 4-025-01, *Security Engineering: Waterfront Security*

UFC 4-152-01, *Design: Piers and Wharves*

US DEPARTMENT OF ENERGY

<http://www.energy.gov>

National Best Practices Manual, Daylighting and Windows

Building Energy Software Tools Directory

http://apps1.eere.energy.gov/buildings/tools_directory/

This Page Intentionally Left Blank

APPENDIX B BEST PRACTICES: INTERIOR

B-1 MAINTENANCE.

Refer to Sections 8.5.5 and 12.6.8 in the *IES Lighting Handbook*, Lighting Quality, for maintenance best practices.

B-1.1 Visibility.

Large tasks generally require less illuminance, brightness, and contrast to be performed. Small detailed tasks may require task lighting to increase the light level significantly. Knowing a description of the task is essential to designing the lighting for that task. The luminance or brightness of a task increases the task visibility. Brighter tasks are easier to see, so long as it is not so much brighter than its surroundings that it becomes uncomfortable or a source of direct glare. As task contrast decreases, the light level required to see it will increase. If the contrast is too low, it will be difficult to distinguish various components of the task, reducing visibility.

B-1.2 Glare.

Direct glare can be minimized with careful equipment selection and placement. . Indirect or reflected glare is caused by light reflecting off the task in such a manner that the contrast is “washed out”. Many work situations position the light directly in front of the task, producing reflected glare.

Like direct glare, indirect glare can be minimized with the type and layout of lighting equipment. Locate direct light to the side or behind a critical task. Use semi-indirect light to bounce light off of surfaces in order to provide uniform low glare light with less reflected glare. Direct luminaires that are immediately over an individual can cause glare even though the light source is not in the field of view. This type of glare can produce the same negative effects as direct or reflected glare including eye strain and headaches.

Figure B-1. Examples of direct glare



B-1.2.1 Considerations to Minimize Glare.

- Indirectly light the ceiling and walls for interior ambient lighting systems.
- Use direct light only in limited amounts for task and accent light.

B-1.3 Uniformity.

Lighting level or illuminance uniformity is important on work surfaces where sustained tasks are performed as well as on wall and ceiling surfaces that make up a significant portion of the field of view. Poor uniformity can cause adaptation problems. It is very important to prevent “spotty” lighting especially in interior areas where people are working.

Figure B-2. Uniform ceiling brightness



Figure B-3. Uniform illuminance



B-1.3.1 Maintaining Uniformity.

Carefully consider changes in lighting systems and furniture systems so that lighting uniformity is not compromised. As shown in Figure B-4, a lighting system that provides uniform illuminance on the work-plane in one furniture configuration may not provide the same uniformity in a different configuration.

In the case shown, an additional luminaire is required to adequately light the center workstation. This increases the amount of energy required to light the same area. In such a condition, the use of a semi-indirect, pendant system will provide better uniformity and at the same time allow for flexibility in the workstation layout.

Figure B-4. A change in furniture configuration affects the task plane illuminance uniformity⁴

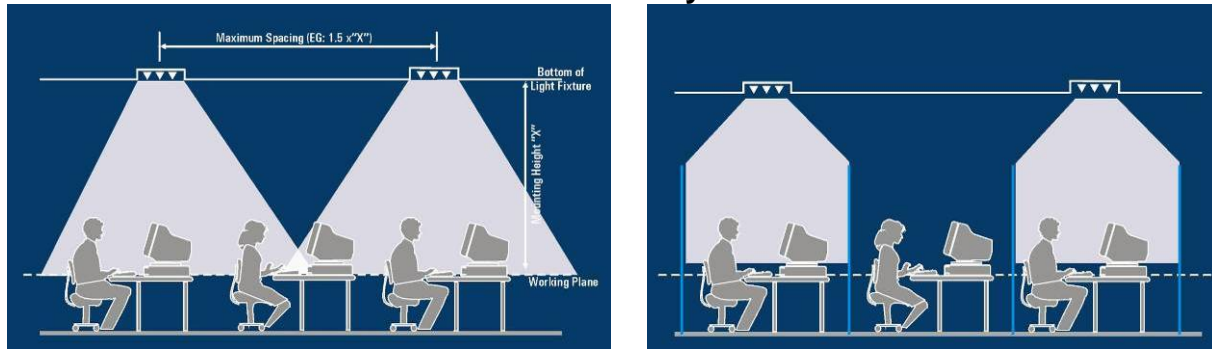

B-1.3.2 Considerations for Uniformity.

- In office areas, uniformity should not exceed 5:1 in immediate work surrounds, not including accent lighting.

B-1.4 Illuminance.

In many cases illuminance is no longer a top priority. Lighting wall and ceiling surfaces is usually more important than providing high levels of horizontal illuminance. In order to provide flexibility and interest in a space, light ceiling and wall surfaces with lower ambient lighting levels. Provide higher illuminance levels with individualized task lighting.

B-1.4.1 Considerations for Adequate Illuminance.

- Design ambient lighting levels to 1/3 to 1/2 task lighting levels. Add task lighting to increase light level.
- Use white light for exterior lighting.

B-1.5 Surface Brightness.

Traditionally, illuminance has been the basis of lighting design; however, we see brightness. We do not see lighting levels. There are three different types of visual responses: Photopic or our day vision (10 cd/m² and higher), Scotopic or our night vision (0.001 cd/m² and below) and mesopic or a combination of night and day vision (0.001 cd/m² to 10 cd/m²). (*IES Handbook, 10th Edition, page 2.14*).

We “see” brightness; we don’t see lighting levels or lux. Our perception of spaces depends on how surfaces are lighted. The factors that lead to brightness as a response are: object luminance, surround luminance, state of adaptation, gradient, and spectral content⁵. It is important to light vertical surfaces such as walls and building facades as a

⁴ Used with permission. Hayden McKay Lighting Design.

⁵ “Perceptions and Performance”, *The IES Lighting Handbook*, Chapter 4, Tenth Edition (New York: The

first priority, then horizontal surfaces such as ceilings and canopies. The least effective surfaces to light are floors.

**Figure B-5. Downlighting only results in spaces feeling dark and “cave-like”.
Lighting surfaces improves the feel of the space**



Figure B-6. Example of the same space with downlighting only (left) and then with improved surface brightness (right)

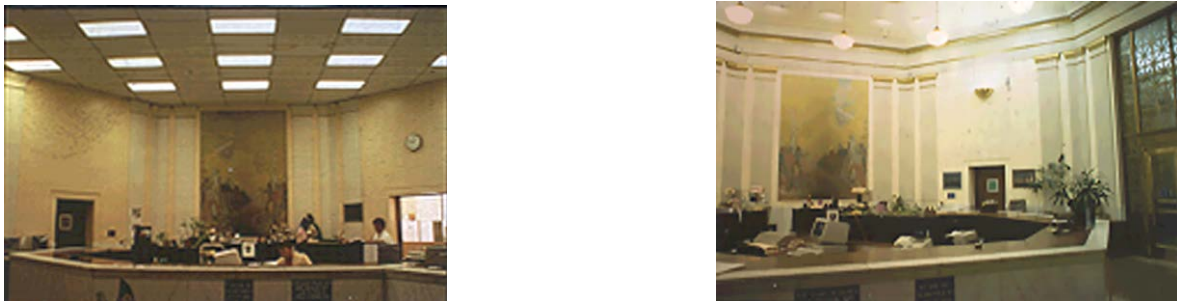

B-1.5.1 Low Ceiling Applications.

In some applications, the ceiling height may be low and cannot be increased to accommodate pendant mounted lighting equipment. In these cases, the lighting design should still try to address the issue of surface brightness. One way to achieve surface brightness with low ceiling conditions is with recessed downlight / wallwash luminaires. The reflector on these luminaires looks similar to a standard downlight, but also uses a modification to light adjacent walls evenly. It is also designed to put light high on the wall next to the ceiling.

Indirect lighting provides better visibility for offices and computer tasks than parabolic luminaires. Additionally, the installation cost of pendants can be lower than recessed troffer luminaires due to the reduced number of connection points. In low ceiling applications where a semi-indirect pendant system is not feasible, consider semi-specular parabolic troffers for lighting the interior of the space. Downlight / wallwashers around the perimeter of the space increase the surface brightness of the walls. This strategy is a better choice to eliminate glare than the use of lensed troffers. However, avoid parabolic troffers designed to spread the light. These achieve wide distributions by lowering the light sources in the luminaire and thereby increasing the glare.

Semi-indirect pendant manufacturers offer short pendant luminaires for low ceiling applications. These luminaires use refined optics to spread light out and light the ceiling with a pendant length of under 12 in (0.3 m). These luminaires allow semi-indirect lighting systems in spaces with a ceiling height of 8 ft (2.4 m).

B-1.5.2 Considerations for Surface Brightness.

- Provide high surface reflectances for walls (60% minimum) and ceilings (85% minimum).
- Light ceilings with semi-direct wall or pendant mounted lighting.
- Light walls with wall washers.
- Direct daylight to ceilings and walls.
- For exterior applications, light vertical surfaces that are in pedestrians' field of view.

B-2 LIGHT SOURCES.

B-2.1 Technical Characteristics.

Refer to Chapter 7 of the *IES Lighting Handbook*.

B-2.2 Light Source Efficacy.

Refer to Chapter 13 of the *IES Lighting Handbook*.

B-2.3 Material Issues.

Fluorescent, metal halide, induction, and high-pressure sodium light sources contain liquid mercury to produce the mercury vapor necessary for operation. When light sources are broken or incinerated the mercury may be released into the soil or the atmosphere. Mercury has been linked to potential health risks. Some light source manufacturers offer product series that feature reduced mercury content.

B-2.4 Recycling.

Traditional light source types except incandescent sources contain some level of mercury. These light sources should be recycled to avoid release of any mercury into landfills. The cost of recycling light sources should be included in any life-cycle cost analysis.

B-3 EQUIPMENT PERFORMANCE.

B-3.1 Flicker.

HID light source sources will flicker due to the changes in line voltage. This flicker effect may be noticeable in certain applications and can be effectively eliminated with the use of high frequency electronic ballasts⁶. If electronic ballasts are not used, the phases can be rotated to minimize flicker.

SSL luminaires can flicker when dimmed, especially with incompatible dimming controls and inadequate electrical infrastructure. Provide dimmer compatible with SSL luminaires and ensure that electrical infrastructure is adequate to operate SSL luminaires.

B-3.2 Noise.

Provide ballasts with a Class A noise rating.

B-3.3 Interference.

Electronic ballasts and SSL drivers have the potential to cause Electromagnetic Interference (EMI) and Radio Frequency Interference (RFI) when operated near other high frequency electronic equipment. This can be a significant issue when installed near electronic medical equipment. To prevent such interference, specify magnetic ballasts in those areas. Another more energy efficient option that will also avoid such interference is low frequency electronic ballasts. Available from some manufacturers, these ballasts operate at low frequencies and will not interfere with sensitive equipment. These ballasts should be specified with <20% Total Harmonic Distortion (THD). SSL drivers should also be selected and rated for use near sensitive equipment, complying with FCC Title 47 Part 15.

B-3.4 Effects of Temperature.

Ambient air temperature affects the performance and output of fluorescent, SSL, and induction light sources. In exterior, low temperature applications (less than ten degrees C) provide ballasts capable of low temperature light source starts. Light output will be reduced until the light source warms up to operating temperature. Mercury amalgams added to fluorescent light sources improve the light source performance and provide for

⁶ "Light Sources: Technical Considerations", *Lighting Handbook Reference and Application*, Chapter 7, Tenth Edition (New York: The Illuminating Engineering Society of North America, 2011), p. 7.45.

operation over a wide temperature range. These light sources typically take slightly longer to reach normal operating temperature and full light output. Alternatively, some lamp manufacturers provide standard lamps with an additional low temperature jacket or sleeve. This type of casing can increase the air temperature immediately around the lamp and improve performance. Low temperature has a positive effect on SSL sources, improving their life. High temperatures improve the starting time of fluorescent light sources but also can degrade all electronic ballasts, drivers, and SSL. For SSL luminaires, LM79 and LM80 testing reports show the lumen depreciation over time and temperature.

B-3.5 Life.

The operating temperature of ballasts, drivers, generators and power control units directly affects the life. The luminaire housing or enclosure should provide for adequate dissipation of heat. When ballasts, drivers, generators or power control units operate at excessive temperatures, the insulation degrades, resulting in a shortened ballast generator or power control unit life. High operating current in SSL luminaires can also shorten life. Review LM-80, LM-79, and TM-21 data to determine actual life with designated operating current.

The life expectancy data given by light source manufacturers refers to the approximate time at which 50% of the light sources in a group are no longer operating, except for LED, which is the operating time over which the LED light source will maintain 70% (L70) of its initial light output. The life of standard incandescent and tungsten halogen sources can be extended by dimming them 5% - 10%. Frequent switching of fluorescent sources can reduce the light source life. However, the use of rapid start or programmed ballasts reduces the impact of frequent starting on the light source life. Recent developments in light source technology have introduced long life light sources that have four to five times the life of standard incandescent light sources. Examples include SSL and induction light sources with useable lives of 50,000-70,000 hours.

B-4 CONTROL APPROACHES.

Lighting controls have the benefit of reducing energy use when lighting is not required. However, the cost of the control device increases the initial system cost. For most applications, typical energy savings pay for control devices in approximately 3-7 years. This payback makes lighting control an attractive energy saving strategy. It is important to note that electric lighting controls should be incorporated with a daylight design to gain any energy savings from the daylight.

B-4.1 Occupancy Based Controls.

Occupancy sensors automatically turn the lights on when an occupant enters a space and automatically turn the lights off after a predetermined period in which no human activity is sensed. Vacancy sensors automatically turn the lights off after a predetermined period in which no human activity is sensed. The occupant manually turns on the lights when he or she enters the space. The operating technologies behind

either an occupancy or vacancy sensor are: passive infrared (detecting heat), ultrasonic (detecting sound), or dual technology (which detects both heat and sound).

Occupancy based controls may be ceiling mounted to cover large spaces or they may be integrated with wall switches for smaller spaces. Occupancy based controls are ideal for areas of convenience such as storage rooms where individuals often have their hands full when entering or leaving. For private offices, it may be ideal to have an auto-on occupancy sensor that turns the lights on to a preset light level, such as 50% with a manual 100%, and then automatically turns the lights off. Manual override may be necessary in spaces where the lights occasionally need to be turned off with occupants such as classrooms and conference rooms. It may also be useful to group luminaires and control with a single occupancy or vacancy sensor. Ballast selection should match control strategies. Controls should have a time delay that can be adjusted up to 30 minutes. If the sensor fails, local override control should be available or the system should revert to the ON position. Table B-2 below summarizes strategies for selecting the appropriate occupancy based control sensor.

B-4.2 Bi-Level and Multi-Level Switching.

Bi-level switching allows for step dimming of the lamps in a two lamp luminaire to be switched independently. Bi-level switching should be used in stairwells and similar low occupancy spaces such as hallways to reduce energy consumption. Controls should fail in the full on position. Spaces should be equipped with bi-level luminaires controlled by an integrated or separate occupancy sensor. When the space is unoccupied; lighting should be reduced by a minimum percentage of 50% and maintain the minimum life safety code requirement for egress when the building is occupied. When utilizing bi-level switching in Means of Egress, the lighting and controls comply with NFPA 101.

Multi-level switching allows multiple light sources within a luminaire to be switched independently. For example, a three lamp luminaire would offer four light output settings: 100%, 66%, 33%, and OFF.

B-4.3 Light Level Tuning.

Light level tuning is used to adjust the maximum light level to precisely set the lighting requirements based on the preference of the occupants in the space, the color of the carpets, office furniture, cubicles, walls, etc. Different spaces can have different maximum light levels and the ability to adjust the high-end output of the luminaire can offer typical lighting energy savings of 20% or more.

B-4.4 Scene Based Dimming.

One button touch allows multiple zones of light within a space to go to the appropriate light levels, known as a scene, for a specific task or use. Scene based control should allow the integration of AV controls, shading, and lighting to work seamlessly with one button touch (i.e. lights dim, projection screen lowers, and shades go down).

B-4.5 Manual Switching.

Manual switching may be an ideal strategy where automatic control is not allowed, such as electrical rooms. The energy savings is diminished though, so a switch should be integrated with an occupancy based sensor, where allowed.

B-4.6 Time Clocks.

Time clocks control larger areas or groups of luminaires. They automatically adjust lighting levels based on the time of day or astronomical events such as sunrise and sunset. This type of control may be applicable in spaces where there is constant occupancy, limited daylight, and minimal activity in non-peak hours of the day.

B-4.7 Personal Control.

This provides an occupant with the ability to control and dim their own lighting even in an open office configuration. Personal controls may be accomplished with personal control over task lighting at a workstation.

B-4.8 Network Control Systems.

A network control system will be required to integrate into a building automated, energy management system. Even in cases where integration with a building management system is not feasible, it may be appropriate to have a stand-alone lighting network control system. There are varying methods to create a network control system. A wireless based system may provide the greatest flexibility and configuration options because zones can be created through software for spaces that may be reconfigured over time. The network control system should have the capability of controlling each luminaire to allow maximum flexibility for energy savings and reconfiguration of the spaces.

B-4.9 Interior Controls Summary.

Refer to Table B-2 for a summary of control strategies and their applications.

Table B-1. Summary of Control Strategies and Their Application

	Switching	Dimming	Network Controls	Building Automated System
Space Type	Enclosed	Open, shared	Enclosed Open, shared	Enclosed Open, shared
Occupant Type	Stationary Single user	Stationary Multiple users	Stationary Non-stationary Single or multiple users	Stationary Non-stationary Single or multiple users
Tasks Type	Simple	Precision	Simple Precision	Simple Precision
Cost	\$	\$\$	\$\$\$	\$\$\$
Construction Type	Retrofit New Construction	Retrofit New Construction	Retrofit New Construction	Retrofit New Construction
Daylight Availability	Yes	Yes	Yes	Yes
Potential Energy Savings	Low-Medium	Medium	Medium-High	Medium-High
Integration with Other Systems (HVAC)	No	No	No	Yes

Table B-2. Recommended Control Devices for Different Building Applications.⁷

Space Type	Wallbox Occ. Sensor	Ceiling/Wall Occ. Sensor	Personal Occ. Sensor	Vacancy Sensor	Time Switch	Time Clock	Multilevel Switching	Manual Wallbox Dimmer	Wireless Remote Dimmer	Photoswitch	Photosensor
Assembly & Light Manufacturing			○			●	○			○	●
Auditoriums		●					○	●	●		
Classrooms		●					●	●	●	○	●
Concourses, Lobbies, Malls						●	●			●	●
Conference Rooms	○	●		●			○	●	●		●
Exterior Lighting		○				●	○			●	
File/Storage Rooms		●		●	●						
Grocery/Supermarket		●			○	●	●			○	○
Gymnasiums		●					○			○	
Hallways		●				●				●	○
Laboratories		●	○				○	●			●
Library Reading Areas		●				○	○				●
Library Stacks		●			●	○	○				
Locker Rooms		●				○	○				
Lunch/Break Rooms	○	●		●			○			○	
Medical Suite/Exam Rooms	○	●		●			●	●			
Museums		○					●	●		○	●
Open Offices		○	●			●	●	●			●
Private Offices	○	●	●	●		●	●	●			●
Restaurants						○	●	●	○		○
Restrooms	○	●			○		○				
Retail Sales Area						○		○		○	○
Warehouse		●			○	●	●			○	○

● = good application ○ = limited application

⁷ New Buildings Institute, Inc. "Lighting Controls", *Advanced Lighting Guidelines*, Chapter 8. 2001 Edition, 8-5, 8-12. Neither the sponsors, authors, editors, advisors, publisher, or the New Buildings Institute, Inc. nor any of its employees make any warranty, express or implied, or assumes any legal liability or responsibility for the accuracy, completeness or usefulness of any data, information, method, product or process disclosed in this document, or represents that its use will not infringe any privately-owned rights, including but not limited to, patents, trademarks or copyrights. © 2001 by New Buildings Institute, Inc. All rights reserved.

Table B-3. Lighting Control Energy Savings Examples by Application and Control Type⁸

Space Type	Controls Type	Lighting Energy Savings (Demonstrated in Research or Estimated as Potential)	Study Reference
Private Office	Occupancy Sensor	38%	<i>An Analysis of the Energy and Cost Savings Potential of Occupancy Sensors for Commercial Lighting Systems</i> , Lighting Research/EPA, August 2000. <i>Lighting Controls Effectiveness Assessment</i> , ADM Associates for Heschong Mahone Group, May 2002. <i>Occupant Use of Manual Lighting Controls in Private Offices</i> , IESNA Paper #34, Lighting Research Center. "Effect of Interior Design on the Daylight Availability in Open Plan Offices", by Reinhart, CF, National Research Council of Canada, Internal Report NRCC-45374, 2002.
	Multilevel Switching	22%	
	Manual Dimming	6-9%	
	Daylight Harvesting (sidelighting)	50% (manual blinds) to 70% (optimally used manual blinds or automatic shading system)	
Open Office	Occupancy Sensors	35%	National Research Council study on integrated lighting controls in open office, 2007. <i>Lighting Controls Effectiveness Assessment</i> , ADM Associates for Heschong Mahone Group, May 2002. "Effect of Interior Design on the Daylight Availability in Open Plan Offices", by Reinhart, CF, National Research Council of Canada, Internal Report NRCC-45374, 2002. National Research Council study on integrated lighting controls in open office, 2007.
	Multilevel Switching	16%	
	Daylight Harvesting (sidelighting)	40%	
	Personal Dimming Control	11%	
Classroom	Occupancy Sensor	55%	<i>An Analysis of the Energy and Cost Savings Potential of Occupancy Sensors for Commercial Lighting Systems</i> , Lighting Research/EPA, August 2000. Lighting Controls Effectiveness Assessment, ADM Associates for Heschong Mahone Group, May 2002. <i>Sidelighting Photocontrols Field Study</i> , Heschong Mahone Group, 2003.
	Multilevel Switching	8%	
	Daylight Harvesting (sidelighting)	50%	

⁸New Buildings Institute, Inc. "Lighting Controls", *Advanced Lighting Guidelines*, 2010. Neither the sponsors, authors, editors, advisors, publisher, or the New Buildings Institute, Inc. nor any of its employees make any warranty, express or implied, or assumes any legal liability or responsibility for the accuracy, completeness or usefulness of any data, information, method, product or process disclosed in this document, or represents that its use will not infringe any privately-owned rights, including but not limited to, patents, trademarks or copyrights. © 2010 by New Buildings Institute, Inc. All rights reserved.

B-5 CONTROL EQUIPMENT.

B-5.1 Sensors.

B-5.1.1 Occupancy Based Controls.

An occupancy sensor is used for interior applications to automatically turn the lights on when an occupant enters the space and automatically turn the lights off after a period of undetected occupancy.

A vacancy sensor requires the occupant to manually turn the lights on when they enter the space and the sensor automatically turns the lights off after a period of undetected occupancy. More energy is saved when using vacancy sensors as occupants may not always require electric lighting when entering a space.

B-5.1.1.1 Passive Infrared.

Passive infrared (PIR) sensors detect the difference in heat between a human and the surroundings. Because of this, the sensor has to be able to “see” the entire space and any obstruction such as partitions, shelves, or cabinets will block detection. Changes in ambient temperature will also reduce the effectiveness of the infrared sensors. The pattern of occupancy is dispersed in a fan shape where the distance between fan blades is small near the sensor, but increases as the fan blades are directed away from the sensor.

Figure B-7. Coverage Pattern of PIR Sensor

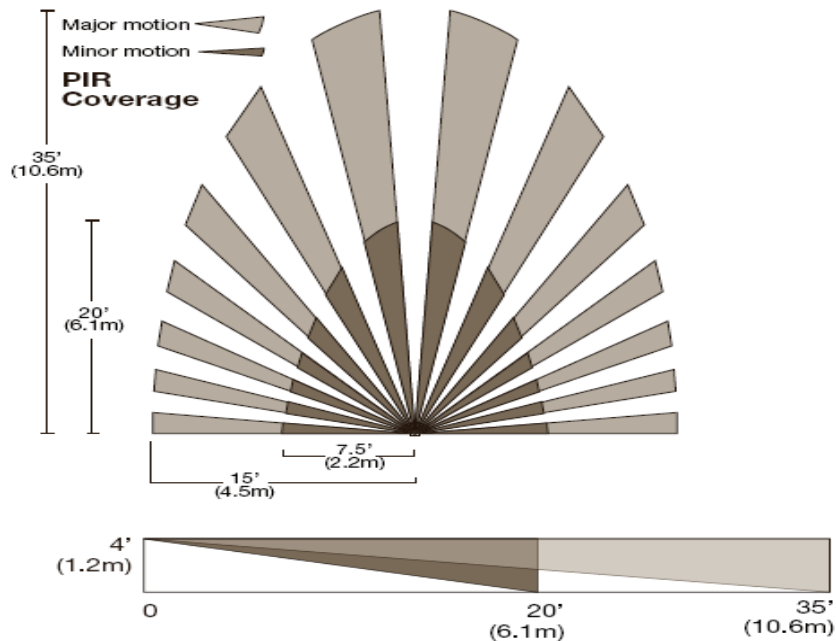

B-5.1.1.2 Ultrasonic.

Ultrasonic technology relies on high frequency sound waves to detect movement in the space. This movement could be a person moving, or air movement created by a person's activity. This type of sensor is therefore appropriate for spaces that have partitions such as restrooms or open office areas. Such sensors need to be located so that they do not sense the "false-occupancy" of an air vent or a passer-by in an adjacent space. Room finishes such as carpeting may absorb the ultrasonic waves and reduce effectiveness.

Figure B-8. Coverage Pattern of Ultrasonic Sensor

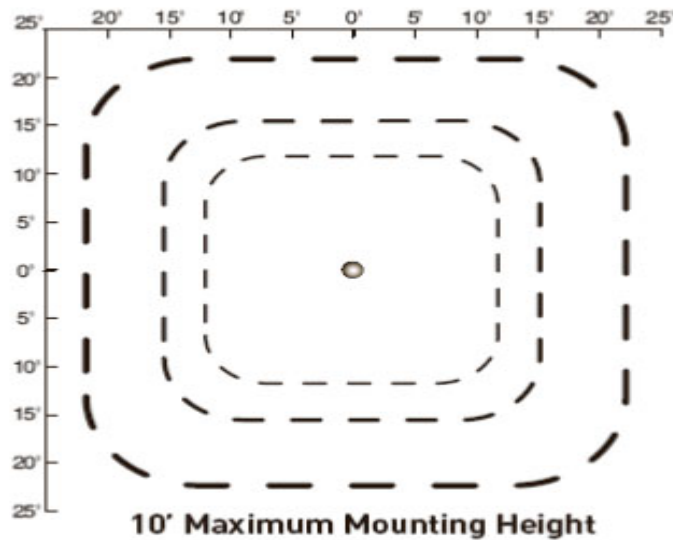

B-5.1.1.3 Dual Technology.

Dual technology sensors combine both the capabilities of PIR and ultrasonic to detect occupancy. Both an ultrasonic and PIR detection of occupancy is required for the lights to turn on but only one sensor technology is required for the lights to remain on. This type of sensor is best used in large spaces with low occupant activity levels.

Figure B-9. Coverage Pattern of Dual Technology Sensor
(Courtesy of Wattstopper/Legrand)

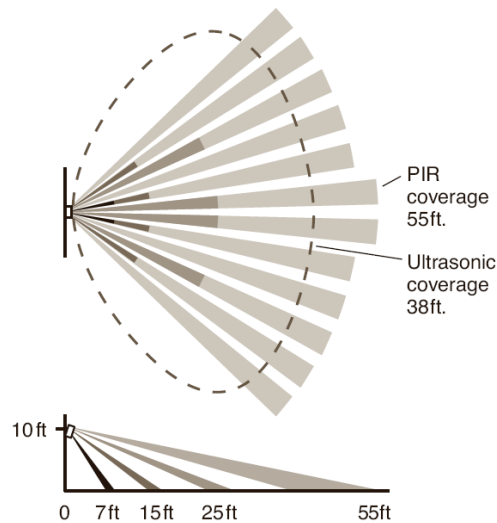

B-5.1.1.4 Microphonic.

Microphonic occupancy sensors have been released to the market. These sensors use passive infrared technology to first detect motion and then use a microphone to hear occupants. This dual technology sensor uses less power than ultrasonic sensors. When this technology is available from three different manufacturers, designers may consider the technology as a viable occupancy sensor.

B-5.1.1.5 Considerations.

Each type of occupancy or vacancy sensor should be equipped with a time delay. This time delay leaves the lights on for a predetermined amount of time after the last occupant has been detected. The purpose of the time delay is to ensure that occupants are not left without lighting and to reduce the number of on/off cycles. Since occupancy patterns vary with time of day as well as day of the week, and are not easily scheduled, it is best to select a time delay that works for both periods of increased and decreased occupant activity. Manufacturers typically have preset time delays at 5, 10, 15, 20, or 30 minutes. It is recommended that a time delay setting of 10 minutes be used for most spaces. Should another time delay setting be selected, consideration should be given to the increased energy consumption, ballast type, and increased life of the light source due to the reduced number of on/off cycles.

In addition to the time delay, there should also be a setting for the sensitivity. The sensitivity will need to be calibrated appropriately according to the activity in the space. For example, if there is limited movement in the space, the sensitivity should be calibrated to detect very slight movement.

Table B-4. Guide for Using Sensors

DO	DON'T
Use ultrasonic sensors in large open areas with partitions or furniture	Use ultrasonic sensors where there is high air flow.
Place sensors in proximity to where the main activity in the space will occur.	Install an in-wall sensor where it is blocked by furniture or behind the door.
Use PIR in enclosed spaces.	Use ultrasonic sensors in small, enclosed spaces where they may react to activity outside the space.
For large areas, create zones of light to manage light.	Install ultrasonic or dual tech sensors higher than 12 feet.
Overlap sensor coverage patterns by at least 20% to ensure adequate coverage.	Install sensors within 6 feet of an HVAC vent.
Ensure PIR line of sight does not extend out doorways. This can be achieved by either sensor placement or lens masking.	Use PIR sensors when there are multiple obstructions (furniture, partitions) which prevent line of sight of the sensor.

B-5.1.2 Self-Adapting.

Self-adapting technologies “learn” how the space is used by occupants and adjusts the lights as necessary. The technology responds in real-time and automatically adjusts both the sensitivity of the sensor and the delay time. Self-adapting sensors are best used in spaces where neither the occupants nor the activities vary from day to day. Self-adapting technology is not recommended for classrooms and conference rooms, but may be ideal for private offices.

B-5.2 Manual.

Considerable energy savings can be achieved by allowing occupants to control (on/off) or vary the light levels.

Energy savings from dimming lights is nearly linear (i.e. dimming fluorescent lights by 30% saves 25% in electricity, dimming them by 50% saves 40% in electricity and so on). Furthermore, users seldom require maximum light levels and studies show that allowing users to adjust illuminance for different tasks saves 35-42% lighting energy.

B-5.2.1 Switches.

Manual controls for occupants can be a good way to increase worker autonomy and give occupants greater control ability, although the energy savings is not as great as automatic controls. Manual switches work best in spaces where there is only one occupant in control of the space, such as private offices. Bi-level and multi-level switches equipment is possible to increase energy savings and control flexibility.

B-5.2.2 Dimmers.

Manual dimming occurs with a control action initiated by the occupant. This type of dimming may be useful in spaces where several different activities can take place. A conference room is an example where the lights may need to be dimmed for an A/V presentation, but also may need to be full output for meetings. Manual dimming also results in high satisfaction rating for occupants and should be encouraged for regularly occupied areas.

B-5.3 Time Controls.

B-5.3.1 Time Switch.

Automatic switching takes place in conjunction with occupancy controls when the space becomes unoccupied. The lights turn off after a designated period of inactivity.

B-5.3.2 Time Clock.

A time clock is a device that automatically adjusts the lights at a specific time or based on astronomical events such as sunrise or sunset. Manufacturers typically allow the preset time to vary between 5 minutes and 12 hours. This type of control may be applicable in spaces where there is constant occupancy, limited daylight, and minimal activity in non-peak hours of the day.

B-5.3.3 Schedule.

A preset schedule can be programmed to automatically turn the lights on or off based upon trends in occupancy. Different schedules are created for weekdays, weekends, evenings, and holidays.

B-6 NETWORK CONTROL SYSTEM.

A network control system can be connected in a number of different ways. Implementing addressable ballasts or drivers provides digital addresses for all ballasts or drivers and connects them as a system through network cabling. The digital addresses allow control over each ballast or driver individually and allow for flexibility of the system as the needs of the space evolve over time. A wireless system communicates with all devices (sensors, dimming ballasts, dimming drivers, and area controllers) over radio frequency. The zoning of such a system is configured through software and provides flexibility as the needs of the space evolve over time.

The IES Technical Memorandum (IES TM-23-2011) *Lighting Control Protocols* provides technical information regarding the varying architectures, topologies, and protocols that are currently available for lighting controls. The document may be useful especially when integrating one protocol with another or integrating a lighting control system with a building automation system. Typical uses are outlined along with limits/extends, interoperability with other protocols, and designer responsibilities specification recommendations.

B-7 EMERGENCY AND EXIT LIGHTING.

Mark and illuminate means of egress in accordance with NFPA 101. The purpose of emergency lighting is to ensure the continuation of illuminance along the means of egress from a building and provide adequate light for the orderly cessation of activities in the building. The purpose of exit lights is to identify the means of egress. Both types of lighting are powered from both a normal power source and an emergency source, with automatic switching from one to the other.

In some specific situations, emergency lighting might be required for specific spaces or work areas that are not on the means of egress. There are often areas where work of a critical nature has to continue regardless of loss of normal power, such as a computer server room. In health care facilities, including hospitals, skilled nursing homes, and residential custodial care facilities, lighting for the means of egress (including exit signs) and elevator cabs is considered “life safety” lighting and connected to the life safety branch of the facility’s emergency power system. Task illumination at anesthetizing locations, patient care areas, laboratories, intensive care units, recovery rooms, and other locations as required by NFPA 70, Article 517 are considered “critical” lighting and powered from the critical power branch of the facility’s emergency power system. In applications where the loss of light, even momentary, would endanger personnel or risk other loss or damage, provide lighting systems to maintain constant illumination through the use of an uninterruptible power supply of sufficient capacity to permit an orderly cessation of activity.

Figure B-10, Typical Exit Sign



B-7.1 Testing of Emergency Lighting Equipment.

Because of the periodic testing requirements, accessibility of equipment is an important design consideration. Consider self-testing or self-diagnostic emergency lighting equipment.

B-8 REPLACEMENT OF LUMINAIRES.

B-8.1 Recessed Troffers.

Convert T-12 lighting systems to LED or T-8 light sources and electronic high frequency ballasts. In most cases, de-lamp 4-lamp luminaires to either 2- or 3-lamp. White painted reflectors should be installed in older parabolic troffers. Install new lenses in lensed troffers if existing lenses are more than 7 years old.

T-12 fluorescent light sources come in a nominal 4 ft (1.2 m) length and are therefore suitable for retrofit with T-8 light sources. T5 and T5HO light sources are a metric length and slightly shorter than T-12 and T-8 light sources. These light sources cannot be supplied in place of the 4 ft (1.2 m) light sources and also may not be an appropriate brightness. Luminaires need to be specifically designed for use with T5 and T5HO light.

B-8.2 Incandescent Downlights.

Remove the incandescent light source and socket, and install a hardwired compact fluorescent adapter using a standard plug-based LED or compact fluorescent light source. It is important to consider the base orientation for CFL sources as some may not be suitable for all orientations and source life may be compromised. In many cases, replacement of the reflector is also required to efficiently utilize the compact fluorescent light source.

In some cases, hardwired conversions can be difficult or not cost effective. Use a medium based adapter with integral ballast and replaceable compact fluorescent light source. Compact fluorescent light source watts should be about 20 percent to 30 percent or less than original incandescent light source watts to achieve similar light levels. Some of these light sources can be dimmed. However, not all compact fluorescent or LED medium base light sources can be used with the base up or in a recessed housing. Check specifications for allowable applications.

B-8.3 Fluorescent Industrial Luminaires, Wraparound, and Strip Lights.

Replace F40T12, and F48T12 light sources and magnetic ballasts with LED or T-8 light sources and electronic high frequency program start ballasts.

For lighting systems employing F96T12 slimline and F96T12/HO light sources, consider all of the following:

- Retrofitting with electronic high frequency ballasts and continuing to use existing light sources.

- Replacing 8 ft (2.4 m) light sources with 4 ft (1.2 m) LED or T-8 light sources, possibly including high light output ballasts and high output LED or T-8 light sources when replacing T12/HO light sources.
- Replacing 8 ft (2.4 m) light sources with T-8 8 ft (2.4 m) light sources and electronic high frequency ballasts.

B-8.4 HID, Floodlights, Downlights and Other Luminaires.

- Replace mercury vapor lighting systems with one of the following approaches:
- Replace mercury vapor light sources with compatible LED, metal halide or induction light sources, especially if increased light levels are required.
- For interior high bay applications, replace existing luminaires with a linear fluorescent, induction system or LED system. This replacement is especially appropriate for applications where switching or dimming could be encouraged to save energy in addition to improving visibility. Fluorescent retrofits are not a one-for-one replacement of HID luminaires but rather an alternate lighting system.

B-8.5 Exit Signs.

Retrofit incandescent exit signs with LED type.

B-8.6 Lighting Control System.

Consider lighting controls for a lighting replacement project to improve the energy efficiency of the space. Use the installed cost of the system when analyzing the lifecycle cost for a lighting replacement with controls. Integrate the lighting control system directly into the HVAC system to provide reduced HVAC load requirements and improve the buildings energy efficiency.

This Page Intentionally Left Blank

APPENDIX C BEST PRACTICES: DAYLIGHTING

C-1 INTRODUCTION.

Refer to Chapter 14 of the *IES Lighting Handbook* and IES RP-5 *Daylighting Buildings* for additional information.

C-2 SYSTEM INTEGRATION.

If the majority of areas are daylighted, then the electric lighting becomes supplemental during daytime periods. Since our appetite for light is less in the evening and nighttime hours, daylighting does not need to be duplicated with electric lighting. Design electric lighting to supplement the daylighting. For example, when daylight is plentiful, the electric lighting dims near the daylight source. In other areas where the daylight penetration is not as great, the electric lighting can be increased. Electric lighting controls (daylight, occupancy, and vacancy sensors) can typically save up to 50% of the lighting energy in existing buildings and up to 35% in new buildings⁹.

C-3 CONTROLS.

C-3.1 Daylight Sensor Technologies.

Open loop photosensors determine the light level by measuring the outside light availability. Based upon the light level measured, a signal is sent to the electric lighting to either increase or decrease the light level depending on the exterior daylight availability.

Closed loop photosensors determine the light level in a space by measuring the inside light availability. Based upon the light level measured, a signal is sent to the electric lighting to either increase or decrease the light level depending on the interior daylight availability. Table C-1 provides a summary of daylight sensor technologies.

⁹ New Buildings Institute, Inc. "Lighting Controls", *Advanced Lighting Guidelines*, Chapter 8. 2001 Edition, p. 8-1

Table C-1. Summary of Daylight Sensors

Use This Equipment	In This Type of Space	And Be Aware for These Issues
Open loop	Spaces where the outside daylight availability gives an accurate representation of the daylight entering into the space.	<ul style="list-style-type: none"> -Sensor should be placed outside or inside pointed towards the daylight opening -Use multiple sensors for spaces with more than one daylight opening -Outside conditions are accounted for, but not space conditions (geometry and reflectance)
Closed loop	Spaces where a constant level of illumination is desired.	<ul style="list-style-type: none"> -Room surfaces (reflectances) may affect the light level readings -More reliable and effective at measuring light levels than open loop photosensors

A hybrid adaptation of open loop and closed loop sensors is available. Open loop systems only measure changes in daylight, and not changes in electric lighting. This reduces the likelihood of system imbalance, but by locating these sensors outside of the space does not provide the most accurate daylight dimming, but can cause some system imbalance. A hybrid system is located in the space for accurate daylight dimming, but by subtracting the electric lighting contribution to the sensor, system imbalance is not a problem.

C-3.2 Automatic Lighting Controls.

Automatic dimming is used in conjunction with daylight sensors.

Continuous dimming provides a seamless transition of light level to occupants. The light level is adjusted over a period of typically several seconds does not distract occupants which is ideal for daylight availability dimming. Step dimming creates more abrupt changes in light level. The range of dimming is limited to a few preset light levels and does not allow for transitions and may be noticeable, even distracting, to occupants.

C-3.3 Task Dominant Areas.

Task dominant area examples include offices, conference rooms, classrooms, maintenance areas, and other regularly occupied areas. Daylight dimming provides the highest level of satisfaction since the lighting smoothly responds to daylight availability versus an abrupt on/off. Ideally, manual dimming with an upper daylight limit provides

the greatest flexibility and highest acceptance since people have control over their areas. In addition, occupancy and vacancy sensors turn off the lighting if no one is in the area.

C-3.4 Non-Task Dominant Areas.

Non-task dominant area examples include transition areas such as corridors, lobbies, atriums, or support areas such as cafeterias, restrooms, and storage areas. Exterior lighting is typically a non-task dominated area. Automatic daylight on/off or bi-level switching is acceptable in these areas, yet dimming is still preferred. Occupancy sensors in these public areas will save the most energy, though lights can be turned off with an energy management system. If occupancy devices allow adequate time, especially in transition areas, then the lighting is not disrupted during normal hours of operation.

C-3.5 Control Strategies.

Luminaires in primary and secondary zones switch or dim in response to daylight. See Figure C-1 for layout of primary and secondary zones. Locate sensors according to manufacturer's recommendations. Integrate electric lighting with daylight controls. The electric lighting should begin to dim when the daylight contribution exceeds the target illuminance level on the task plane. Continuous dimming is recommended over step dimming to minimize visual disruption to occupants. Harvesting daylight is best suited in spaces that are frequently occupied and a significant amount of daylight enters the space.

When selecting daylight zones, consider the exterior environment in addition to the proximity to glazing. As Figures C-2 and C-3 indicate, if exterior buildings or foliage are blocking some of the daylight contribution into the building, treat those zones as secondary. Note that the zoning will change depending on the floor level. Locate the electric lighting parallel to the daylight zones for dimming control. During periods of peak daylight availability, daylight levels should be at least two times greater than the design criteria for electric lighting in the primary daylight control zone. Secondary zones typically have one half to one third of the design criteria for electric lighting.

Figure C-1. Daylight Control Zones

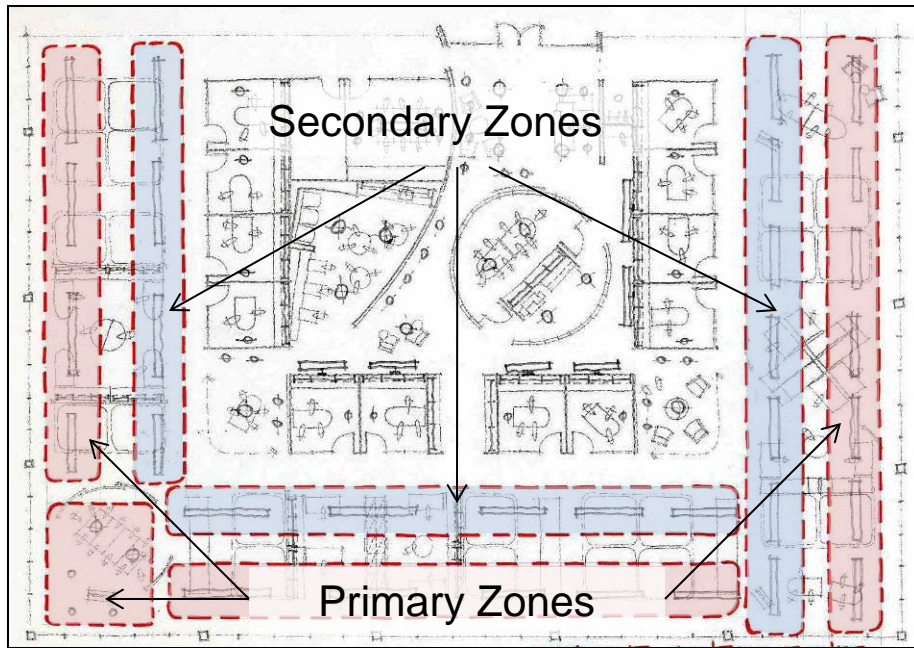

Figure C-2. Daylight Control Zones with Obstructions (Upper Floors)

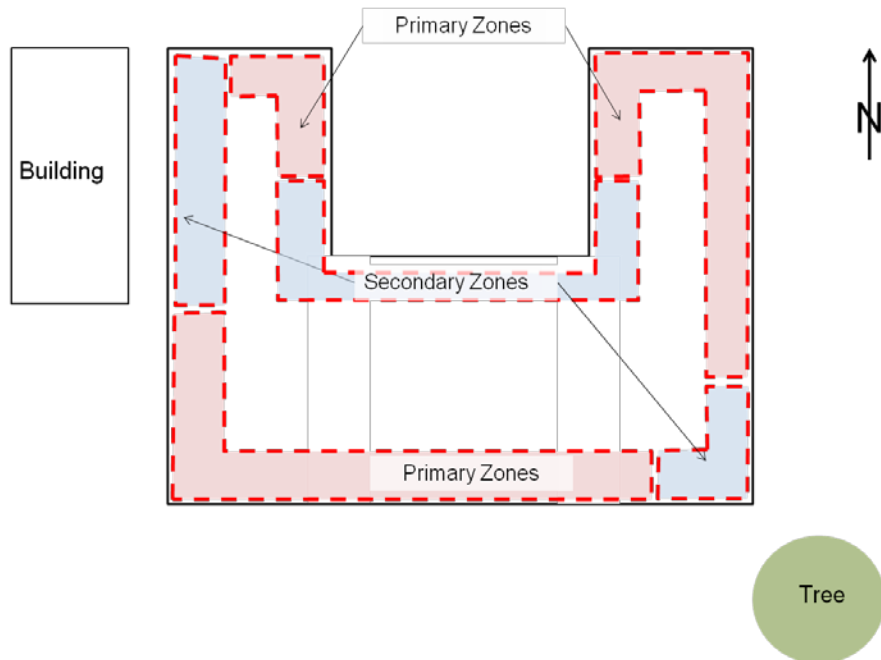
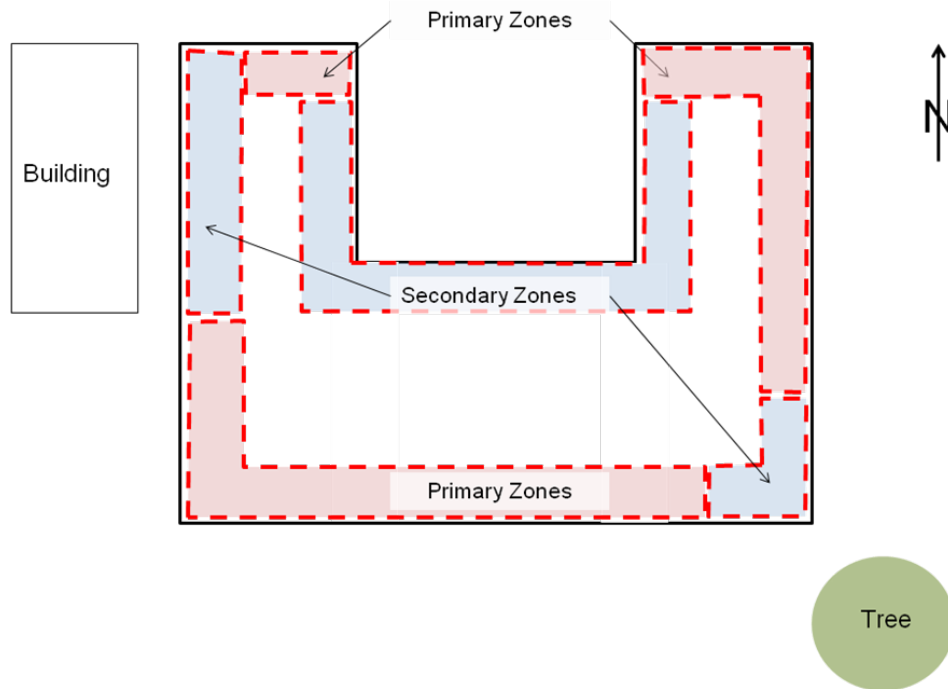

Figure C-3. Daylight Control Zones with Obstructions (Lower Floors)



C-4 AUTOMATED SHADING.

When utilizing automated shading, coordinate daylighting controls with automated shading controls.

This Page Intentionally Left Blank

APPENDIX D BEST PRACTICES: EXTERIOR

D-1 LIGHTING QUALITY.

D-1.1 Luminance.

There are three different types of visual responses: Photopic or our day vision (10 cd/m² and higher), Scotopic or our night vision (0.001 cd/m² and below) and mesopic or a combination of night and day vision (0.001 cd/m² to 10 cd/m²). (*IES Lighting Handbook* page 2.14). The majority of exterior lighting is designed in the mesopic range.

Photopic sensitivity peaks at 555 nm in the green-yellow range. Scotopic vision sensitivity peaks at 507 nm more in the blue light range. Mesopic vision varies between these values depending on the lighting level. As the lighting levels become lower, light sources with more blue or short wavelength light become more effective in nighttime vision.

D-1.1.1 Mesopic.

Since light source lumen ratings are all based on photopic sensitivity, they need to be adjusted for nighttime applications. Per the IES, photopic and mesopic lumens have to be determined from the spectral power distribution of the light source. In addition, photopic luminous efficiency function applies to visual fields of size 2 degrees or less. (*IES Handbook, 10th Edition*, page 5.7). This means that only tasks that are on-axis or one that is focusing straight ahead apply to the photopic light source lumen ratings. Any task that is in our peripheral vision does not. Peripheral vision shifts to shorter wavelength sensitivity. (*IES Handbook, 10th Edition*, page 5.8).

Mesopic multipliers may be used to account for the improved visibility provided by white light. The process for calculating mesopic multipliers can be performed with luminance values or with illuminance values that are converted to luminance values as a function of the background reflectance. Table 26.6 in the *IES Lighting Handbook* provides an example for how mesopic multipliers can be applied to average illuminance values. Point by point mesopic multipliers, as outlined in *CIE 191:2010 Recommended System for Mesopic Photometry Based on Visual Performance* adjusts not only the average luminance, but also the uniformity.

D-1.2 Light Pollution.

Light pollution or sky glow is caused by light aimed directly up into the sky and by light reflected off the ground or objects. Sky glow prevents the general public and astronomers from seeing the stars.

Floodlights, wall packs, and other un-shielded luminaires are the major contributors to sky glow. Overlighting, even with shielded luminaires, reflects unnecessary light back into the atmosphere and adds to the sky glow. This often occurs at outdoor areas such as motor pools and sports fields.

Figure D-1. Los Angeles, 1908 (left), Los Angeles, 2002 (right)¹⁰

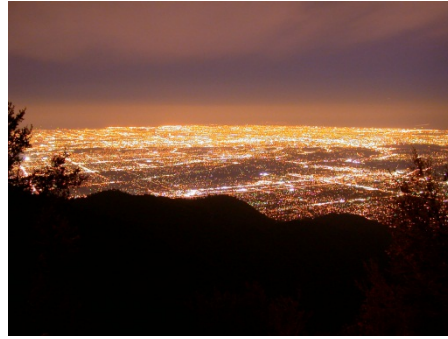
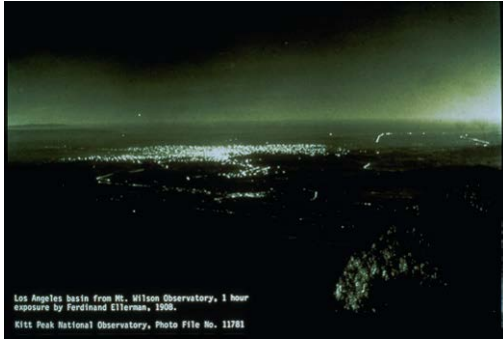
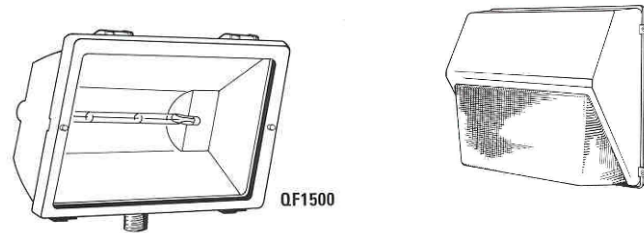
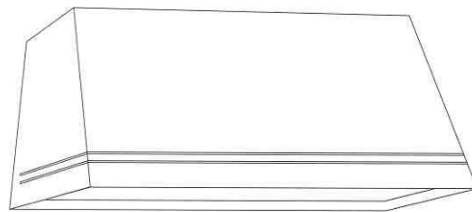

Figure D-2. Unshielded and non-cutoff luminaires lead to light pollution



To minimize light pollution, use fully shielded luminaires for area and roadway lighting as illustrated in Figure D-3. The use of full cutoff (fully shielded) luminaires may reduce uniformity and therefore require greater pole heights or spacing. Unshielded luminaires may also be used at low mounting heights if the lumen output of the light source is limited to 4200 lumens. These applications, such as pedestrian and entry lighting, typically require greater vertical illuminance for facial identity. Provide uniform low glare lighting and do not overlight exterior areas. Also, control lighting with time clocks, photocells, and motion sensors such that lighting is only energized when needed.

Figure D-3. Examples of IES fully shielded luminaires



D-1.3 Light Trespass.

¹⁰ © 2003 by Prof. Dr. Gerhard Eisenbeis University of Mainz/Germany

Light trespass is referred to as nuisance glare or the “light shining in my window” effect. It is usually caused by a glare source that is bright compared to the darker night surround. Since glare inhibits our ability to “see” tasks and decreases contrast, minimize glare. Uncontrolled light sources (floodlights) are usually the cause of light trespass. Not only does light trespass cause neighbor annoyance, but it also increases light pollution.

Figure D-4. Uncontrolled light source



To minimize light trespass, use only fully shielded luminaires for area lighting. When unshielded luminaires such as wall packs and decorative luminaires are used at low mounting heights, reduce the light source brightness to that of a 4200 lumen light source (similar to a 55 watt induction light source) or less. Do not overlight areas because reflected light can also result in complaints and poor visibility by increasing visual adaptation. Also, consider dimming or turning lighting off when not needed and activate with motion sensors or timers when activity occurs.

Figure D-5. Fully shielded or IES fully shielded luminaires (left) are recommended. Do not use unshielded floodlights (right)



D-1.3.1 Third Party Certification.

When pursuing third party certification for light pollution and light trespass, designers should consider the multiple-building environment of most military installations. The certification may limit the amount of light trespass on adjacent properties. However, in many cases, spill light from one project may be desired to light another area. Adjacent projects all have the same owner. The certification calls for control of interior lighting during nighttime hours to prevent light from trespassing to exterior areas. Automatic lighting controls that turn lights OFF or to low dimmed levels during nighttime hours such as occupancy sensors or time clocks should be used to perform this function. Furthermore, automated window shades or dynamic glazing systems can be used on the windows to prevent light from escaping during nighttime hours.

D-2 LUMINAIRE CLASSIFICATION.

The National Electrical Manufacturers Association (NEMA) classifies exterior luminaires by intensity distribution. Tables D-1 and D-2 describe the distribution and cutoff classifications. Table D-1 refers to the illuminance patterns produced on the ground or horizontal; whereas Table D-2 refers to the vertical candela distribution of light from an individual luminaire. Exterior sports lighting luminaires are classified to the width of the beam spread and the projection distance to the field. Table D-2 outlines these seven classifications.

Each successive classification provides more vertical illuminance, but also introduces more glare and stray uplight. It is important to note that the classification of exterior luminaires has changed. The shielding classification such as Full Cutoff has been replaced by the BUG (Backlight-Uplight-Glare) rating system. Table D-3 shows how the two classifications are correlated. A rating of 0-5 is applied to each of the three zones: Backlight Zone, Uplight Zone, and Glare Zone. For example, the term Full Cutoff corresponds to a "0" in the Uplight Zone (U0). For more information, see, IES TM-15.

Table D-1. Exterior Luminaire Distribution Classification¹¹





Type	Description	Plan View
Type I	Narrow, symmetric illuminance pattern.	
Type II	Slightly wider illuminance pattern than Type I.	
Type III	Wide illuminance pattern.	
Type IV	Widest illuminance pattern.	
Type V	Symmetrical circular illuminance pattern.	
Type VS	Symmetrical, nearly square illuminance pattern.	

Table D-2. NEMA Field Angle Classifications¹²

Beam Type	Beam Spread Degree Range	Projection Distance
1	10 to 18	240 ft and greater
2	18 to 29	200 to 240 ft
3	29 to 46	175 to 200 ft
4	46 to 70	145 to 175 ft
5	70 to 100	105 to 145 ft
6	100 to 130	80 to 105 ft
7	130 and up	under 80 ft

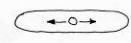
D-2.1 BUG Rating System.

The backlight, uplight and glare (BUG) ratings for luminaires are useful in evaluating optical performance in exterior environments. The BUG ratings are based on zonal lumen calculations. More information can be found in IES TM-15-11 “*Luminaire Classification System for Outdoor Luminaires*”. It is difficult to compare the BUG ratings to the previously used cutoff classifications as the cutoff classifications are determined from intensities (candela) of the light source above 80 degrees, rather than luminaire lumens. Table D-3 below illustrates the lack of correlation between the previous

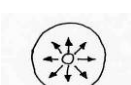
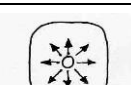
¹¹ “Luminaires: Forms and Optics”, *Lighting Handbook Reference and Application*, Chapter 8, Tenth Edition (New York: The Illuminating Engineering Society of North America, 2011), p. 8.10.

¹² “Luminaires: Forms and Optics”, *Lighting Handbook Reference and Application*, Chapter 8, Tenth Edition (New York: The Illuminating Engineering Society of North America, 2011), p. 8.9.

classification system and the current BUG ratings. The three components of BUG ratings are illustrated in Figure D-6.

Table D-3. Correlation between BUG Ratings and Cutoff Classifications

BUG Rating	Full Cutoff	Cutoff	Semi-Cutoff	Non-Cutoff
B	B0-B5	B0-B5	B0-B5	B0-B5
U	U0	U1-U5	U1-U5	U1-U5
G	G0-G5	G0-G5	G0-G5	G0-G5

D-2.1.1 Backlight.

Backlight (B) Rating: Backlight creates light trespass on adjacent sites. The B rating takes into account the amount of backlight in the low (BL), medium (BM), high (BH) and very high (BVH) zones, which are in the direction of the luminaire opposite from the area intended to be lighted. The closer to a property line, the B rating is stricter or lower. If the luminaire is located more than two mounting heights from the property line, then the B rating is higher.

D-2.1.2 Uplight.

Uplight (U) Rating: Uplight causes artificial sky glow. Lower uplight (UL) cause the most sky glow and negatively affects professional and academic astronomy. Upper uplight (UH) not reflected off a surface is mostly energy waste. The U rating defines the amount of light into the upper hemisphere with greater concern for the light at our near the horizontal angles (UL).

D-2.1.3 Glare.

Glare (G) Rating: Glare can be annoying or visually disabling. The G rating takes in to account the amount of frontlight in the high (FH) and very high (FVH) zones and amount of back light in the high (BH) and very high (BVH) zones.

D-2.1.4 Considerations.

In general, a higher BUG rating means that more light is emitted in the solid angles and the allowable rating increases with higher lighting zones. However, a higher B (backlight) rating simply indicates that the luminaire directs a significant portion of light behind the pole, so B ratings are designated based on the location of the luminaire with respect to the property boundary. A high B rating luminaire maximizes the spread of light, and is effective and efficient when used far from the property boundary. When

luminaires are located near the property boundary, a lower B rating will prevent unwanted light from interfering with neighboring properties.

Figure D-6. Exterior Luminaire BUG Classification

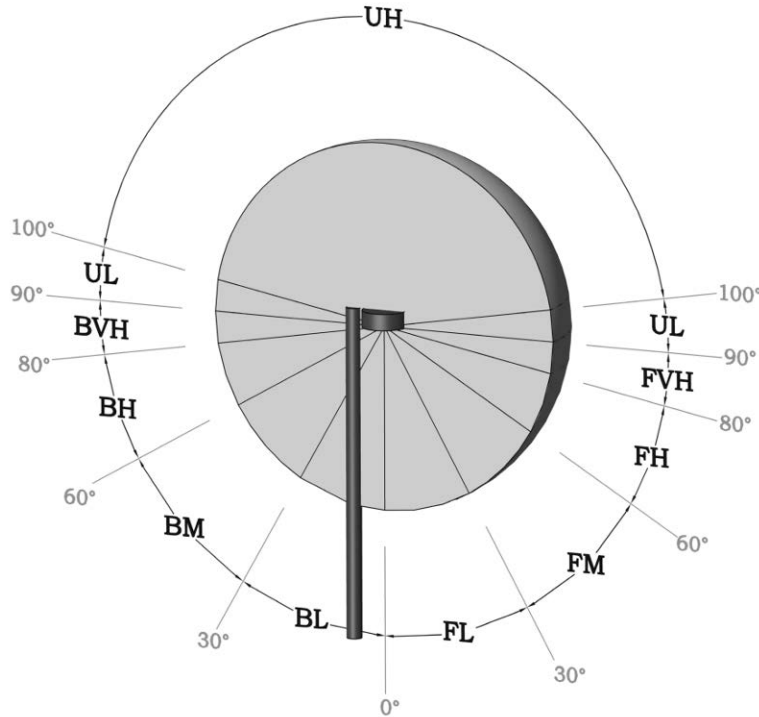

Table D-4: Exterior Luminaire BUG Classification Key

UH	Uplight High
UL	Uplight Low
BVH	Backlight Very High
BH	Backlight High
BM	Backlight Medium
BL	Backlight Low
FVH	Forward Light Very High
FH	Forward Light High
FM	Forward Light Medium
FL	Forward Light Low

D-3 LIGHTING ZONES.

D-3.1 LZ0 No Ambient Lighting.

LZ0 are areas where the natural environment will be seriously and adversely affected by lighting. Impacts include disturbing the biological cycles of flora and fauna and/or detracting from human enjoyment and appreciation of the natural environment. Human activity is subordinate in importance to nature. The vision of human residents and users is adapted to the total darkness, and they expect to see little or no lighting. When not needed, lighting should be extinguished.

D-3.2 LZ1 Low Ambient Lighting.

LZ1 are areas where lighting might adversely affect flora and fauna or disturb the character of the area. The vision of human residents and users is adapted to low light levels. Lighting may be used for safety and convenience but it is not necessarily uniform or continuous. After curfew, most lighting should be extinguished or reduced as activity levels decline.

D-3.3 LZ2 Moderate Ambient Lighting.

LZ2 are areas of human activity where the vision of human residents and users is adapted to moderate light levels. Lighting may typically be used for safety and convenience but it is not necessarily uniform or continuous. After curfew, lighting may be extinguished or reduced as activity levels decline.

D-3.4 LZ3 Moderately High Ambient Lighting.

LZ3 are areas of human activity where the vision of human residents and users is adapted to moderately high light levels. Lighting may typically be used for safety, security and/or convenience and is often uniform and/or continuous. After curfew, lighting may be extinguished or reduced as activity levels decline.

D-3.5 LZ4 High Ambient Lighting.

LZ4 are areas of human activity where the vision of human residents and users is adapted to high light levels. Lighting is generally considered necessary for safety, security and/or convenience and it is mostly uniform and/or continuous. After curfew, lighting may be extinguished or reduced in some areas as activity levels decline.

D-3.6 Considerations to Classify an Area at a Lower Lighting Zone.

- Very low or no activity at night.
- Adjacent lighting zone, either DoD or Civilian, is lower and has a low level of activity.

D-3.7 Considerations to Classify an Area at a Higher Lighting Zone.

- Sensitive areas requiring a high level of security.
- High level of activity at night as well as high number of users.

D-4 CONTROL APPROACHES

D-4.1 Manual Switching.

Manual switching is not ideal for controlling exterior lighting, except in residential applications where a single switch would suffice.

D-4.2 Photocontrol.

A photocell is a device that measures the illuminance level and is set to turn on or off the luminaire at a preset illuminance level. The light levels are set to ideally have the luminaires turn on before sunset and extinguish after sunrise.

D-4.3 Occupancy Based Controls.

The use of motion sensors in exterior applications is widely accepted in residential applications. In commercial or industrial applications, occupancy sensors can be implemented in some applications. It is important to ensure that the occupancy sensor being used does not leave any 'dead' zones where occupancy cannot be detected for safety concerns.

D-4.4 Adaptive Lighting.

Adaptive lighting is concept of adjusting the light levels to suit the activity level. This is accomplished with bi-level switching and motion sensors or preset continuous dimming. When no occupancy is detected in a zone, or late at night when traffic and pedestrian volumes are known to be minimal, lighting levels are reduced to a minimum of 50% full light output. Adaptive lighting is ideally suited for wall mounted, roadway, area, pathway, parking lot or pedestrian luminaires.

All street lighting luminaires are required to have a multi-pin receptacle that is capable of accepting a dimming control node. With a similar form factor to that of a standard photocell, a dimming control node is installed on top of the luminaire. The control node communicates through a networked control system to allow for two-way communication. See Section D-5.3 Network Control Systems for additional information.

D-5 CONTROL EQUIPMENT.

D-5.1 Sensors.

D-5.1.1 Photosensor.

Photosensors can be used as an exterior lighting control strategy. A single photosensor can be installed on each luminaire or on a lighting control center linking a group of luminaires together. Diligently maintain the photosensor.

D-5.1.2 Motion Sensor.

Motion sensors used for exterior luminaires are the same as for interior luminaires. As such, the coverage patterns can be too small and result in coverage gaps when used to control exterior luminaires.

D-5.2 Time Clock.

Time clocks or time switches are used to automatically turn the lights on or off on a daily basis. Typically, time clocks are programmed to turn on and off based on astronomical events such as sunset and sunrise or when activity has ceased. The astronomic time clock automatically keeps track of what day it is and geographic location of the luminaires. As the exact time of sunset and sunrise fluctuates throughout the year, the time clock adjusts accordingly.

D-5.3 Network Control Systems.

Exterior control systems are beginning to follow the same path as interior addressable systems. By communicating with the ballast, driver, generator, or power control unit of each roadway or area luminaire, a centralized control system can monitor a wide range of characteristics including energy consumption and outages. Additionally, this control strategy accommodates the concept of adaptive lighting standards. This concept recognizes that lighting criteria provides for the worst case scenario – conditions that may only exist for a fraction of the night or year. With more advanced control systems and dimmable sources, exterior lighting can provide the appropriate amount of light for the time of day, time of year, weather conditions, etc. while significantly reducing energy use.

D-5.3.1 Power Line Frequency.

A power line carrier network system uses the physical electrical wiring to communicate between devices. Each luminaire has its own device and therefore its own unique address. The devices can then all be linked together to form a network that is adjustable through a software program. From the software, zoning can be established as well as scheduling. Additionally, maintenance issues can be identified. In order to dim, a separate dimming ballast or dimming driver may be required.

D-5.3.2 Radio Frequency.

A radio frequency (RF) lighting control system uses embedded RF transmitters/receivers to connect devices (sensors, user controls, power equipment) to one another. These systems can be stand alone or part of a networked lighting control solution. Care should be taken to evaluate the RF lighting control solution on the frequency range it operates in (is it densely or sparsely populated?), how the system propagates and ensures proper RF communication between devices, RF device installation and cost, and whether the type of space being controlled supports the use of RF devices. A mockup of the RF lighting control system is a recommended best practice to ensure that the system will perform as expected in the application/operating environment.

This Page Intentionally Left Blank

APPENDIX E LIFE CYCLE COST ANALYSIS

E-1 ANALYSIS METRICS.

The following table outlines an example for how to complete a life cycle cost analysis for lighting equipment.

E-1.1 Net Present Value (NPV).

The NPV shown in Table E-1 is calculated as a function of the discount rate, the ten year cash flow model, and the initial cost of the system. Excel has a built in NPV function.

E-1.2 Internal Rate of Return (IRR).

The IRR is calculated as a function of the 10-year cash flow model. Excel has a built in IRR function.

E-1.3 Payback.

The payback value is calculated from the 10-year cash flow model. Payback occurs when the total cash flow has exceeded the cost of the initial investment.

E-2 MAINTENANCE.

The annual number of lamps/light sources replaced is calculated by multiplying the operating hours of the lamp/light source by the total number of luminaires and by the number of lamps/light sources per luminaire. This value is then divided by the rated life of the lamp/light source.

The annual number of ballasts/drivers replaced is calculated by multiplying the operating hours of the ballast/driver by the total number of luminaires and by the number of ballasts/drivers per luminaire. This value is then divided by the rated life of the ballast/driver.

Table E-1: Life Cycle Cost Analysis Example

ROI Analysis	CFL	LED
Net Present Value (NPV)	(\$2,965.32)	\$942.11
Internal Rate of Return (IRR)	-2%	13.3%
PAYBACK (years)	0	3.7
Annual Energy Savings Analysis		
Cost per kWh	\$ 0.100	
	CFL	LED
Annual Operating Hrs	4,380	4,380
Luminaire Description	26W CFL	LED
Input Watts Per Luminaire	29	14
Quantity	50	50
System kWatts	1.4	0.7
Demand Diversity Factor	1.0	1.0
Annual kWh	6,324	3,089
Annual Energy Cost (\$)	\$ 632.36	\$ 308.92
Annual Energy Savings (kWh)	0	3,234
Annual Energy Savings (\$)	\$ -	\$ 323
Annual Energy Savings (%)	0%	51.1%

Annual Maintenance Cost Breakdown	CFL	LED
Annual Operating Hrs	4,380	4,380
Description of System	26W CFL	14W LED
Quantity	50	50
Type of Lamp/Light Source	26W CFL	LED
Lamp/Light Source Life (hrs)	12,000	50,000
Cost of Lamp/Light Source	\$ 7.00	\$ 120.00
# Lamps/Light Sources per Luminaire	1	1
Labor \$ to Spot Relamp per Lamp (\$/hr)	\$ 55.00	\$ 55.00
Duration of lamp/Light source replace.(hr)	0.25	0.25
# of Lamps/Light Sources Replaced Annually	18.3	4.38
Annual Lamp/Light Source Main. Cost	\$ 379	\$ 586
Ballast/Driver Type	0-10 V Ballast	0-10 V Driver
Ballast/Driver Life (hrs)	50,000	50,000
Cost of Ballast/Driver	\$ 150.00	\$ 150.00
# of Ballast/Driver Per Fixture	1	1
Labor \$ to Spot Replace Ballast/Driver (\$/hr)	\$ 55.00	\$ 55.00
Duration of Ballast/Driver replacement (hr)	0.5	0.5
# of Ballasts/Drivers Replaced Annually	4.4	4.4
Annual Ballast/Driver Maintenance Cost	\$ 777	\$ 777
Annual Frequency of Cleaning	1	1
Labor \$ to clean luminaire (\$/hr)	\$ 55.00	\$ 55.00
Duration of cleaning (hr)	0.25	0.25
Annual Cleaning Maintenance Cost	\$ 688	\$ 688
Cost per lamp to dispose	\$0.75	\$0.00
Lamp Disposal Cost	\$ 14	-
Cost per magnetic ballast to dispose	\$4.03	\$0.00
Magnetic Ballast Disposal Cost	\$ 18	-
Annual Dispose Cost	\$ 31	-
Annual Maintenance Costs	\$ 1,875	\$ 2,051
Annual Maintenance Savings (\$)	\$ -	\$ (176)
Annual Maintenance Savings (%)	0%	-9.4%

UFC 3-530-01
01 April 2015
Change 3, 01 June 2016

Initial Cost Estimate		
	CFL	LED
Labor		
Luminaire replacement	\$ 50.00	\$ 50.00
Control Installation	\$ -	\$ -
Sub-Total	\$ 2,500.00	\$ 2,500.00
Materials		
Luminaire unit price estimate	\$ 160.00	\$ 120.00
Controls unit price estimate	\$ -	\$ -
Sub-Total	\$ 8,000.00	\$ 6,000.00
Total Estimated Cost	\$ 10,500.00	\$ 8,500.00
less Estimated Utility Equipment Rebate	\$ -	\$ -
less Estimated Utility Energy Rebate	\$ -	\$ -
Net Project Cost	\$ 10,500.00	\$ 8,500.00

CFL Cash Flow	Year										
	0	1	2	3	4	5	6	7	8	9	10
Energy Savings	\$ -	\$ -	\$ -	\$ -	\$ -	\$ -	\$ -	\$ -	\$ -	\$ -	\$ -
Maintenance Savings	\$ -	\$ -	\$ -	\$ -	\$ -	\$ -	\$ -	\$ -	\$ -	\$ -	\$ -
Deferred Maintenance Savings	\$ 1,875	\$ 1,922	\$ 1,970	\$ 2,019	\$ 2,070						
Initial Investment	\$ (10,500)										
Total Cash Flow	\$ (10,500)	\$ 1,875	\$ 1,922	\$ 1,970	\$ 2,019	\$ 2,070	\$ -	\$ -	\$ -	\$ -	\$ -
		\$ (8,625)	\$ (6,703)	\$ (4,733)	\$ (2,714)	\$ (645)	\$ (645)	\$ (645)	\$ (645)	\$ (645)	\$ (645)

LED Cash Flow	Year										
	0	1	2	3	4	5	6	7	8	9	10
Energy Savings	\$ 323	\$ 338	\$ 353	\$ 369	\$ 386	\$ 403	\$ 421	\$ 440	\$ 460	\$ 481	
Maintenance Savings	\$ (176)	\$ (180)	\$ (185)	\$ (189)	\$ (194)	\$ (199)	\$ (204)	\$ (209)	\$ (214)	\$ (220)	
Deferred Maintenance Savings	\$ 2,051	\$ 2,102	\$ 2,155	\$ 2,208	\$ 2,264						
Initial Investment	\$ (8,500)										
Total Cash Flow	\$ (8,500)	\$ 2,198	\$ 2,260	\$ 2,323	\$ 2,388	\$ 2,455	\$ 204	\$ 217	\$ 231	\$ 246	\$ 261
		\$ (6,302)	\$ (4,042)	\$ (1,719)	\$ 670	\$ 3,125	\$ 3,329	\$ 3,546	\$ 3,778	\$ 4,023	\$ 4,285

3.7

This Page Intentionally Left Blank

APPENDIX F GLOSSARY

ACRONYMS

ANSI	American National Standards Institute
ASHRAE	American Society of Heating, Refrigerating, and Air-Conditioning Engineers
CCT	Correlated Color Temperature
CRI	Color Rendering Index
DOD	Department of Defense
DOE	Department of Energy
EPA	Environmental Protection Agency
FEMP	Federal Energy Management Program
HID	High-Intensity Discharge
HVAC	Heating, Ventilating, and Cooling
Hz	Hertz
IES	Illuminating Engineering Society of North America
kW	Kilowatts
kWh	Kilowatt Hours
LEC	Light Emitting Capacitor
LED	Light Emitting Diode
LLD	Lamp Lumen Depreciation
NEC	National Electric Code
NECA	National Electrical Contractors Association
NEMA	National Electrical Manufacturers Association
NESC	National Electrical Safety Code
NFPA	National Fire Protection Association
OCONUS	Outside Continental United States

O&M	Operations and Maintenance
RFI	Radio Frequency Interference
SAD	Seasonal Affective Disorder
SF	Square Foot
SPD	Surge Protection Device
THD	Total Harmonic Distortion
TLED	Tubular Light Emitting Diode
UFC	Unified Facilities Criteria
UFGS	Unified Facilities Guide Specifications
UL	Underwriters Laboratories
V	Volt
W	Watts

Terms:

Adaptation – the process by which the retina becomes accustomed to more or less light than it was exposed to during an immediately preceding period. It results in a change in the sensitivity to light.

Altitude – the angular distance of a heavenly body measured on the great circle that passes perpendicular to the plane of the horizon, through the body and through the zenith. It is measure positively from the horizon to the zenith, from 0 degrees to 90 degrees.

Ambient Lighting – lighting throughout an area that produces general illumination

Area Lighting Luminaire – a complete lighting device consisting of a light source and ballast, where appropriate, together with its direct appurtenances such as globe, reflector, refractor, housing, and such support as is integral with the housing. The pole, post, or bracket is not considered part of the luminaire.

Average Luminance – luminance is a property of a geometric ray. Luminance as measured by conventional meters is averaged with respect to two independent variables, area and solid angle; both must be defined for a complete description of a luminance measurement.

Azimuth – the angular distance between the vertical plane containing a given line or celestial body and the plane of the meridian.

Baffle – a single opaque or translucent element to shield a source from direct view at certain angles, to absorb or block unwanted light, or to reflect and redirect light.

Ballast – a device used with an electric-discharge light source to obtain the necessary circuit conditions (voltage, current, and waveform) for starting and operating.

Ballast Factor – the fractional flux of a fluorescent light source operated on ballast compared to the flux when operated on the standard (reference) ballast specified for rating light source lumens.

Bollard – luminaires having the appearance of a short, thick post, used for walkway and grounds lighting. The optical components are usually top-mounted.

Bowl – an open-top diffusing glass or plastic enclosure used to shield a light source from direct view and to redirect or scatter the light.

Bracket (mast arm) – an attachment to a light source post or pole from which a luminaire is suspended.

BUG (Backlight, Uplight, Glare) - Backlight – the percent lamp lumens or the luminaire lumens distributed behind a luminaire between zero degrees vertical (nadir) and 90 degrees vertical. Uplight – the percent lamp lumens or the luminaire lumens distributed above a luminaire between 90 and 180 degrees vertical. Glare – the percent lamp lumens or the luminaire lumens distributed 60 and 90 degrees vertical.

Candela, cd – the SI unit of luminous intensity, equal to one lumen per steradian (lm/sr).

Candlepower (cp), $I = d\phi/d\omega$ - luminous intensity expressed in candelas.

Clerestory – that part of a building that rises clear of the roofs or other parts and whose walls contain windows for lighting the interior.

Coefficient of Utilization (CU) – the ratio of luminous flux (lumens) calculated as received on the work plane to the total luminous flux (lumens) emitted by the light sources alone. It is equal to the product of room utilization factor and luminaire efficiency.

Color Matching – the action of making a color appear the same as a given color.

Color Rendering – a general expression for the effect of a light source on the color appearance of objects in conscious or subconscious comparison with their color appearance under a reference light source.

Color Rendering Index (of a light source) (CRI) – a measure of the degree of color shift objects undergo when illuminated by the light source as compared with those same objects when illuminated by a reference source of comparable color temperature.

Color Temperature (of a light source) – the absolute temperature of a blackbody radiator having a chromaticity equal to that of the light source. Refer to Correlated Color Temperature.

Contrast – see *luminance contrast*.

Correlated Color Temperature (of a light source) (CCT) – the absolute temperature of a blackbody whose chromaticity most nearly resembles that of the light source.

Daylight Availability – the luminous flux from the sun plus sky at a specific location, time, date, and sky condition.

Diffused Lighting – lighting provided on the work plane or on an object that is not incident predominantly from any particular direction.

Dimmer – a device used to control the intensity of light emitted by a luminaire by controlling the voltage or current available to it.

Direct Component – that portion of the light from a luminaire that arrives at the work plane without being reflected by room surfaces.

Direct Glare – glare resulting from high luminances or insufficiently shielded light sources in the field of view. It is usually associated with bright areas, such as luminaires, ceilings, and windows that are outside the visual task or region being viewed. A direct glare source can also affect performance by distracting attention.

Direct-Indirect Lighting – a variant of general diffuse lighting in which the luminaires emit little or no light at angles near the horizontal.

Direct Lighting – lighting involves luminaires that distribute 90 to 100% of the emitted light in the general direction of the surface to be illuminated. The term usually refers to light emitted in a downward direction.

Directional Lighting – lighting provided on the workplane or on an object. Light that is predominantly from a preferred direction.

Disability Glare – the effect of stray light in the eye whereby visibility and visual performance are reduced. A direct glare source that produces discomfort can also produce disability glare by introducing a measurable amount of stray light in the eye.

Discomfort Glare – glare that produces discomfort. It does not necessarily interfere with visual performance or visibility.

Downlight – a small direct lighting unit that directs the light downward and can be recessed, surface-mounted, or suspended.

Efficacy – See *luminous efficacy of a source of light*.

Efficiency – See *luminaire efficiency*.

Electroluminescence – the emission of light from a phosphor excited by an electromagnetic field.

Emergency Exit – a way out of the premises that is intended to be used only during an emergency.

Emergency Lighting – lighting designed to supply illumination essential to the safety of life and property in the event of a failure of the normal supply. The system must be capable of providing minimum required illuminance specified in NFPA 101, *Code for Safety to Life from Fire in Buildings and Structures*.

Exit sign – a graphic device including words or symbols that indicates or identifies an escape route or the location of, or direct to, an exit or emergency exit.

Floodlight – a projector designed for lighting a scene or object to a luminance considerably greater than its surroundings.

Fluorescent light source – a low pressure mercury electric-discharge light source in which a fluorescing coating (phosphor) transforms some of the UV energy generated by the discharge into light.

Flush-mounted or Recessed Luminaire – a luminaire that is mounted above the ceiling (or behind a wall or other surface) with the opening of the luminaire level with the surface.

Footcandle, fc – a unit of illuminance equal to 1 lm/ft².

Fully Shielded – the classification for an exterior luminaire where all light emitted by the luminaire, either directly from the light source or a diffusing element, or indirectly by reflection or refraction from any part of the luminaire, is projected below the horizontal. (Definition from the International Dark Skies Association *Outdoor Lighting Code Handbook*.)

Glare – the sensation produced by luminances within the visual field that are sufficiently greater than the luminance to which the eyes are adapted, which causes annoyance, discomfort, or loss in visual performance, and visibility. Direct glare is caused by excessive light entering the eye from a bright light source. The potential for direct glare exists anytime one has a direct view of a light source. With direct glare, the eye has a harder time seeing contrast and details. A system designed solely on lighting levels, tends to aim more light directly towards a task, thus producing more potential for glare. Direct glare can be minimized with careful equipment selection and placement.

Globe – a transparent or diffusing enclosure intended to protect a light source, to diffuse and redirect its light, or to change the color of the light.

High Ambient Temperatures – Above 50 degrees C.

High-Intensity discharge (HID) Light source – an electric-discharge light source in which the light-producing arc is stabilized by bulb wall temperature, and the arc tube has a bulb wall loading in excess of 3 W/cm². HID light sources include groups of light sources known as mercury, metal halide, and high pressure sodium.

High-Mast Lighting – illumination of a large area by means of a group of luminaires that are designed to be mounted in a fixed orientation at the top of a high mast, generally 20 m (65 ft.) or higher.

High-Pressure sodium (HPS) light source – a high intensity discharge (HID) light source in which light is produced by radiation from sodium vapor.

Illuminance – Illuminance refers to the light level, or amount of light falling on a surface. It is measured in lux or footcandles. Horizontal illuminance refers to the amount of light falling on a horizontal surface. This type of illuminance is often measured on a desk, work surface, floor or ground. Vertical illuminance refers to the amount of lighting falling on a vertical surface such as white boards, signs, and walls. Vertical illuminance on people's faces is also important for identification at entries and security checkpoints.

Illuminance (footcandle or lux) meter – an instrument for measuring illuminance on a plane. The instrument is comprised of some form of photodetector with or without a filter driving a digital or analog readout through appropriate circuitry.

Illumination – an alternative but deprecated term for illuminance.

Incandescent filament light source – a light source in which light is produced by a filament heated to incandescence by an electric current.

Indirect Component – the portion of the luminous flux from a luminaire that arrives at the workplane after being reflected by room surfaces.

Indirect lighting – lighting involving luminaires that distribute 90 to 100% of the emitted light upward.

Induction lighting – lighting technology that uses electric current to induce an electromagnetic field within the phosphor coated light source. No filaments are used. Its advantages include instant on/off operation, white light with good color rendering characteristics, and a long light source life of 100,000 hours.

Instant-start fluorescent light source – a fluorescent light source designed for starting by a high voltage without preheating of the electrodes.

Intensity (candlepower) distribution curve – a curve, often polar, that represents the variation of luminous intensity of a light source or luminaire in the plane through the light center.

Isolux (Isofootcandle) line – a line plotted on any appropriate set of coordinates to show all the points on a surface where the illuminance is the same.

Kelvin – the unit of temperature used to designate the color temperature of a light source.

Light source – a generic term for a source created to produce optical radiation.

Light source Lumen Depreciation (LLD) Factor – the fractional loss of light source lumens at rated operating conditions that progressively occurs during light source operation.

Lens – a glass or plastic element used in luminaires to change the direction and control the distribution of light rays.

Light – radiant energy that is capable of exciting the retina and producing a visual sensation.

Light-Emitting Diode (LED) - a p-n junction solid state diode whose radiated output is a function of its physical construction, material used, and exciting current.

Light Loss Factor (LLF) – formerly called maintenance factor. The ratio of illuminance (or exitance or luminance) for a given area to the value that would occur if light sources operated at their (initial) rated lumens and if no system variation or depreciation had occurred.

Light Meter – a common name for an illuminance meter.

Light Source Color – the color of the light emitted by a source.

Louver – a series of baffles used to shield a source from view at certain angles, to absorb or block unwanted light, or to reflect or redirect light.

Low-Bay Lighting – interior lighting where the roof trusses or ceiling height is approximately 7.6 m (25 ft.) or less above the floor.

Low-Pressure Mercury Vapor Light source – a discharge light source (with or without a phosphor coating) in which the partial pressure of mercury vapor does not exceed 100 Pa during operation.

Low-Pressure Sodium (LPS) Light source – a discharge light source in which light is produced by radiation from sodium vapor.

Lumen, lm – SI unit of luminous flux.

Lumen Depreciation – the decrease in lumen output that occurs as a lamp is operated, until failure.

Lumen (or flux) Method – a lighting design procedure used for predetermining the relation between the number and types of light sources or luminaires, the room characteristics, and the average illuminance on the workplane.

Luminaire (light fixture) – a complete lighting unit consisting of a light source or light sources and ballast(s) (when applicable) together with the parts designed to distribute the light, to position and protect the light sources, and to connect the light sources to the power supply.

Luminaire Dirt Depreciation (LDD) – the fractional loss of task illuminance due to luminaire dirt accumulation.

Luminaire Efficiency – the ratio of luminous flux (lumens) emitted by a luminaire to that emitted by the light source or light sources used therein.

Luminance Contrast – the relationship between the luminances of an object and its immediate background.

Luminance ratio – the ratio between the luminances any two areas in the visual field.

Luminous Efficacy of a Source of Light – the quotient of the total luminous flux emitted to the total light source power input. It is expressed in lumens per watt.

Matte Surface – a surface from which the reflection is predominantly diffuse, with or without a negligible specular component.

Means of Egress - an unobstructed and continuous way of exit from any point in a building or structure to a public way.

Mercury Light source - a high-intensity discharge (HID) light source in which the major portion of the light is produced by radiation from mercury operating at a partial pressure in excess of 10s Pa.

Mesopic Vision – vision with fully adapted eyes at luminance conditions between those of photopic and scotopic vision, that is, between about 3.4 and 0.034 cd/nr.

Metal Halide Light source – a high-intensity discharge (HID) light source in which the major portion of the light is produced by radiation of metal halides and their products of dissociation -possibly in combination with metallic vapors such as mercury.

Multi-level Switching - Multi-level switching allows multiple light sources within a luminaire to be switched independently. For example, a three lamp luminaire would offer four light output settings: 100%, 66%, 33%, and OFF.

Orientation – the relation of a building with respect to compass directions.

Overcast Sky – one that has 100% cloud cover; the sun is not visible.

Overhang – the distance between a vertical line passing through a specified point (often the photometric center) of a luminaire and the curb or edge of a roadway.

PAR Light source – See pressed reflector light source.

Partly Cloudy Sky – a sky that has 30 to 70% cloud cover.

Pendant luminaire – See suspended luminaire.

Peripheral Vision – the seeing of objects displaced from the primary line of sight and outside the central visual field.

Photometry – the measurement of quantities associated with light.

Photopic Vision – vision mediated essentially or exclusively by the cones. It is generally associated with adaptation to a luminance of at least 3.4 cd/m².

Point-by-Point Method – a method of lighting calculation, now called the point method.

Point Method – a lighting design procedure for predetermining the illuminance at various location in lighting installations by use of luminaire photometric data.

Point Source – a source of radiation, whose dimensions are sufficiently small, compared with the distance between the source and the irradiated surface, that these dimensions can be neglected in calculations and measurements.

Pole (roadway lighting) – a standard support generally used where overhead lighting distribution circuits are employed.

Programmed Rapid Start – a fluorescent starting method where the cathode is preheated before the light source is ignited. This softer ignition increases the number of starts over the life of the light source.

Quality of Lighting – pertains to the distribution of luminance in a visual environment. The term is used in a positive sense and implies that all luminances contribute favorably to visual performance, visual comfort, ease of seeing, safety, and aesthetics for the specific visual tasks involved.

Rapid-Start Fluorescent Light source – a fluorescent light source designed for operation with a ballast that provides a low-voltage winding for preheating the electrodes and initiating the arc without a starting switch or the application of high voltage.

Rated Light source Life – the life value assigned to a particular type light source. This is commonly a statistically determined estimate of average or of median operational life.

Reflected Glare – glare resulting from reflections of high luminances in polished or glossy surfaces in the field of view.

Reflection – a general term for the process by which the incident flux leaves a (stationary) surface or medium from the incident side without change in frequency.

Reflector – a device used to redirect the flux from a source by the process of reflection.

Scotopic Vision – vision mediated essentially or exclusively by the rods. It is generally associated with adaptation to a luminance below about 0.034 cd/m².

Self-Ballasted Light sources – any arc discharge light source of which the current limiting devices is an integral part.

Solid State Lighting – light sources that generate light through electroluminescence rather than filaments or gas discharge. SSL sources include light emitting diodes (LEDs), organic light emitting diodes (OLEDs), and polymer light emitting diodes (PLED).

Spacing – for roadway lighting, the distance between successive lighting units, measured along the centerline of the street.

Spacing-to-Mounting-Height Ratio – the ratio of the actual distance between luminaire centers to the mounting height above the work plane.

Sun Bearing – the angle measured in the plane of the horizon between a vertical plane at a right angle to the window wall and the position of this plane after it has been rotated to contain the sun.

Suspended (pendant) Luminaire – a luminaire that is hung from a ceiling by supports.

Table Lamp – a portable luminaire with a short stand, suitable for standing on furniture.

Torchiere – an indirect floor light source that sends all or nearly all of its light upward.

Translucent – transmitting light diffusely or imperfectly.

Transmission – a general term for the process by which incident flux leaves a surface or medium on a side other than the incident side, without change in frequency.

Transmittance – the ratio of the transmitted flux to the incident flux.

Transmittance, Visible (T_{vis}) – the percentage of the visible spectrum transmitted.

Transparent – having the property of transmitting rays of light through its substance so that bodies situated beyond or behind can be distinctly seen.

Troffer – a long recessed lighting unit usually installed with the opening flush with the ceiling.

Tungsten-Halogen Light source – a gas-filled tungsten filament incandescent light source containing a certain proportion of halogens in an inert gas whose pressure exceeds 3 atm.

Uniformity - Lighting level or illuminance uniformity is important to work surfaces where sustained tasks are performed as well as on wall and ceiling surfaces that make up a significant portion of the field of view. Poor uniformity can cause adaptation problems. Flicker or strobing of luminaires can cause annoyances as well as headaches and fatigue.

Valance – a longitudinal shielding member mounted across the top of a window or along a wall (and is usually parallel to the wall) to conceal light sources, giving both upward and downward distributions.

Valance Lighting – lighting comprising light sources shielded by a panel parallel to the wall at the top of a window.

Veiling Reflection – regular reflections that are superimposed upon diffuse reflections from an object that partially or totally obscure the details to be seen by reducing the contrast.

Visibility – the quality or state of being perceivable by the eye. Task visibility describes how size, brightness, and contrast of a particular activity affect lighting required to view that activity. Large tasks generally require less illuminance, brightness, and contrast to be performed. Knowing a description of the task is essential to designing the lighting for that task. The luminance or brightness of a task increases the task visibility.

Wayfinding refers to the visual guidance provided by the lighting system and the visual elements illuminated. This guidance may be illuminated signage that directs occupants to various destinations, or it may be more subtle aids such as continuity and hierarchy of lighting equipment that reinforces areas of similar use. In exterior applications, the size and type of lighting equipment provides visual cues about the surroundings.

Volt – the difference in electrical potential between two points in a circuit.

Watt – the unit of power (rate of doing work). In electrical calculation, one watt is the power produced by a current of one ampere across a potential difference of one volt.

Workplane – the plane on which a visual task is usually done, and on which the illuminance is specified and measured.